



Chipsmall Limited consists of a professional team with an average of over 10 year of expertise in the distribution of electronic components. Based in Hongkong, we have already established firm and mutual-benefit business relationships with customers from,Europe,America and south Asia,supplying obsolete and hard-to-find components to meet their specific needs.

With the principle of “Quality Parts,Customers Priority,Honest Operation,and Considerate Service”,our business mainly focus on the distribution of electronic components. Line cards we deal with include Microchip,ALPS,ROHM,Xilinx,Pulse,ON,Everlight and Freescale. Main products comprise IC,Modules,Potentiometer,IC Socket,Relay,Connector.Our parts cover such applications as commercial,industrial, and automotives areas.

We are looking forward to setting up business relationship with you and hope to provide you with the best service and solution. Let us make a better world for our industry!



Contact us

Tel: +86-755-8981 8866 Fax: +86-755-8427 6832

Email & Skype: info@chipsmall.com Web: www.chipsmall.com

Address: A1208, Overseas Decoration Building, #122 Zhenhua RD., Futian, Shenzhen, China



Kinetis KL15 Sub-Family

48 MHz Cortex-M0+ Based Microcontroller

Designed with efficiency in mind. Compatible with all other Kinetis L families as well as Kinetis K1x family. General purpose MCU featuring market leading ultra low-power to provide developers an appropriate entry-level 32-bit solution.

This product offers:

- Run power consumption down to 47 μ A/MHz in very low power run mode
- Static power consumption down to 2 μ A with full state retention and 4 μ s wakeup
- Ultra-efficient Cortex-M0+ processor running up to 48MHz with industry leading throughput
- Memory option is up to 128 KB flash and 16 KB RAM
- Energy-saving architecture is optimized for low power with 90 nm TFS technology, clock and power gating techniques, and zero wait state flash memory controller

MKL15ZxxVFM4
MKL15ZxxVFT4
MKL15ZxxVLH4
MKL15ZxxVLK4

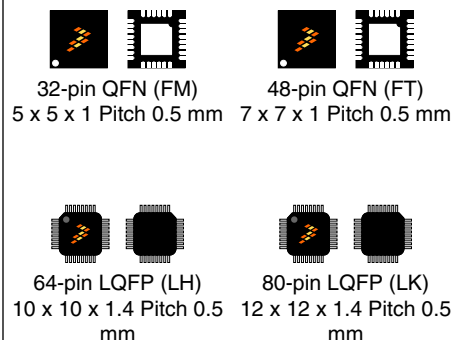

Performance

- 48 MHz ARM[®] Cortex[®]-M0+ core

Memories and memory interfaces

- Up to 128 KB program flash memory
- Up to 16 KB SRAM

System peripherals

- Nine low-power modes to provide power optimization based on application requirements
- COP Software watchdog
- 4-channel DMA controller, supporting up to 63 request sources
- Low-leakage wakeup unit
- SWD debug interface and Micro Trace Buffer
- Bit Manipulation Engine

Clocks

- 32 kHz to 40 kHz or 3 MHz to 32 MHz crystal oscillator
- Multi-purpose clock source
- 1 kHz LPO clock

Operating Characteristics

- Voltage range: 1.71 to 3.6 V
- Flash write voltage range: 1.71 to 3.6 V
- Temperature range (ambient): -40 to 105°C

Human-machine interface

- Low-power hardware touch sensor interface (TSI)
- Up to 70 general-purpose input/output (GPIO)

Communication interfaces

- Two 8-bit SPI modules
- One low power UART module
- Two UART modules
- Two I2C module

Analog Modules

- 16-bit SAR ADC
- 12-bit DAC
- Analog comparator (CMP) containing a 6-bit DAC and programmable reference input

Timers

- Six channel Timer/PWM (TPM)
- Two 2-channel Timer/PWM modules
- Periodic interrupt timers
- 16-bit low-power timer (LPTMR)
- Real time clock

Security and integrity modules

- 80-bit unique identification number per chip

Ordering Information

Part Number	Memory		Maximum number of I/O's
	Flash (KB)	SRAM (KB)	
MKL15Z32VFM4	32	4	28
MKL15Z64VFM4	64	8	28
MKL15Z128VFM4	128	16	28
MKL15Z32VFT4	32	4	40
MKL15Z64VFT4	64	8	40
MKL15Z128VFT4	128	16	40
MKL15Z32VLH4	32	4	54
MKL15Z64VLH4	64	8	54
MKL15Z128VLH4	128	16	54
MKL15Z32VLK4	32	4	70
MKL15Z64VLK4	64	8	70
MKL15Z128VLK4	128	16	70

Related Resources

Type	Description	Resource
Selector Guide	The Freescale Solution Advisor is a web-based tool that features interactive application wizards and a dynamic product selector.	Solution Advisor
Product Brief	The Product Brief contains concise overview/summary information to enable quick evaluation of a device for design suitability.	KL1 Family Product Brief ¹
Reference Manual	The Reference Manual contains a comprehensive description of the structure and function (operation) of a device.	KL15P80M48SF0RM ¹
Data Sheet	The Data Sheet includes electrical characteristics and signal connections.	KL15P80M48SF0 ¹
Chip Errata	The chip mask set Errata provides additional or corrective information for a particular device mask set.	KINETIS_L_xN97F ²
Package drawing	Package dimensions are provided in package drawings.	QFN 32-pin: 98ASA00473D ¹ QFN 48-pin: 98ASA00466D ¹ LQFP 64-pin: 98ASS23234W ¹ LQFP 80-pin: 98ASS23174W ¹

1. To find the associated resource, go to <http://www.freescale.com> and perform a search using this term.
2. To find the associated resource, go to <http://www.freescale.com> and perform a search using this term with the “x” replaced by the revision of the device you are using.

Figure 1 shows the functional modules in the chip.

Kinetis KL15 Family

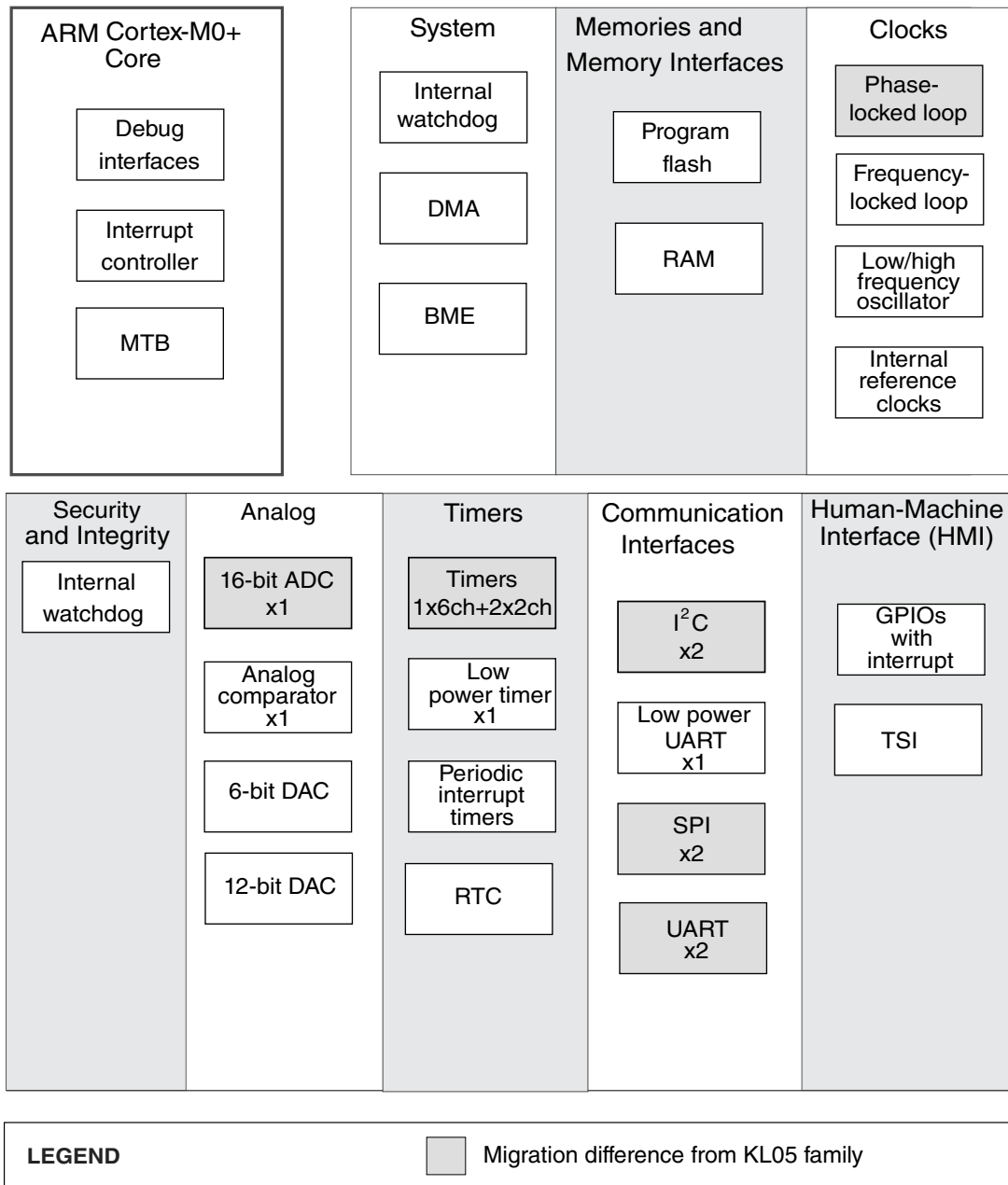

Figure 1. Functional block diagram



Table of Contents

1	Ratings.....	5	3.6.2	CMP and 6-bit DAC electrical specifications.....	31
1.1	Thermal handling ratings.....	5	3.6.3	12-bit DAC electrical characteristics.....	32
1.2	Moisture handling ratings.....	5	3.7	Timers.....	35
1.3	ESD handling ratings.....	5	3.8	Communication interfaces.....	35
1.4	Voltage and current operating ratings.....	5	3.8.1	SPI switching specifications.....	35
2	General.....	6	3.8.2	Inter-Integrated Circuit Interface (I2C) timing.....	40
2.1	AC electrical characteristics.....	6	3.8.3	UART.....	41
2.2	Nonswitching electrical specifications.....	6	3.9	Human-machine interfaces (HMI).....	41
2.2.1	Voltage and current operating requirements.....	7	3.9.1	TSI electrical specifications.....	41
2.2.2	LVD and POR operating requirements.....	7	4	Dimensions.....	42
2.2.3	Voltage and current operating behaviors.....	8	4.1	Obtaining package dimensions.....	42
2.2.4	Power mode transition operating behaviors.....	9	5	Pinout.....	42
2.2.5	Power consumption operating behaviors.....	10	5.1	KL15 Signal Multiplexing and Pin Assignments.....	42
2.2.6	EMC radiated emissions operating behaviors.....	15	5.2	KL15 pinouts.....	45
2.2.7	Designing with radiated emissions in mind.....	16	6	Ordering parts.....	49
2.2.8	Capacitance attributes.....	16	6.1	Determining valid orderable parts.....	49
2.3	Switching specifications.....	16	7	Part identification.....	49
2.3.1	Device clock specifications.....	16	7.1	Description.....	50
2.3.2	General switching specifications.....	17	7.2	Format.....	50
2.4	Thermal specifications.....	17	7.3	Fields.....	50
2.4.1	Thermal operating requirements.....	17	7.4	Example.....	50
2.4.2	Thermal attributes.....	18	8	Terminology and guidelines.....	51
3	Peripheral operating requirements and behaviors.....	18	8.1	Definition: Operating requirement.....	51
3.1	Core modules.....	18	8.2	Definition: Operating behavior.....	51
3.1.1	SWD electricals	18	8.3	Definition: Attribute.....	52
3.2	System modules.....	20	8.4	Definition: Rating.....	52
3.3	Clock modules.....	20	8.5	Result of exceeding a rating.....	52
3.3.1	MCG specifications.....	20	8.6	Relationship between ratings and operating requirements.....	53
3.3.2	Oscillator electrical specifications.....	22	8.7	Guidelines for ratings and operating requirements.....	53
3.4	Memories and memory interfaces.....	24	8.8	Definition: Typical value.....	54
3.4.1	Flash electrical specifications.....	24	8.9	Typical value conditions.....	55
3.5	Security and integrity modules.....	26	9	Revision history.....	55
3.6	Analog.....	26			
3.6.1	ADC electrical specifications.....	26			

1 Ratings

1.1 Thermal handling ratings

Table 1. Thermal handling ratings

Symbol	Description	Min.	Max.	Unit	Notes
T _{STG}	Storage temperature	-55	150	°C	1
T _{SDR}	Solder temperature, lead-free	—	260	°C	2

1. Determined according to JEDEC Standard JESD22-A103, *High Temperature Storage Life*.
2. Determined according to IPC/JEDEC Standard J-STD-020, *Moisture/Reflow Sensitivity Classification for Nonhermetic Solid State Surface Mount Devices*.

1.2 Moisture handling ratings

Table 2. Moisture handling ratings

Symbol	Description	Min.	Max.	Unit	Notes
MSL	Moisture sensitivity level	—	3	—	1

1. Determined according to IPC/JEDEC Standard J-STD-020, *Moisture/Reflow Sensitivity Classification for Nonhermetic Solid State Surface Mount Devices*.

1.3 ESD handling ratings

Table 3. ESD handling ratings

Symbol	Description	Min.	Max.	Unit	Notes
V _{HBM}	Electrostatic discharge voltage, human body model	-2000	+2000	V	1
V _{CDM}	Electrostatic discharge voltage, charged-device model	-500	+500	V	2
I _{LAT}	Latch-up current at ambient temperature of 105 °C	-100	+100	mA	3

1. Determined according to JEDEC Standard JESD22-A114, *Electrostatic Discharge (ESD) Sensitivity Testing Human Body Model (HBM)*.
2. Determined according to JEDEC Standard JESD22-C101, *Field-Induced Charged-Device Model Test Method for Electrostatic-Discharge-Withstand Thresholds of Microelectronic Components*.
3. Determined according to JEDEC Standard JESD78, *IC Latch-Up Test*.

1.4 Voltage and current operating ratings

Table 4. Voltage and current operating ratings

Symbol	Description	Min.	Max.	Unit
V_{DD}	Digital supply voltage	-0.3	3.8	V
I_{DD}	Digital supply current	—	120	mA
V_{IO}	IO pin input voltage	-0.3	$V_{DD} + 0.3$	V
I_D	Instantaneous maximum current single pin limit (applies to all port pins)	-25	25	mA
V_{DDA}	Analog supply voltage	$V_{DD} - 0.3$	$V_{DD} + 0.3$	V

2 General

2.1 AC electrical characteristics

Unless otherwise specified, propagation delays are measured from the 50% to the 50% point, and rise and fall times are measured at the 20% and 80% points, as shown in the following figure.

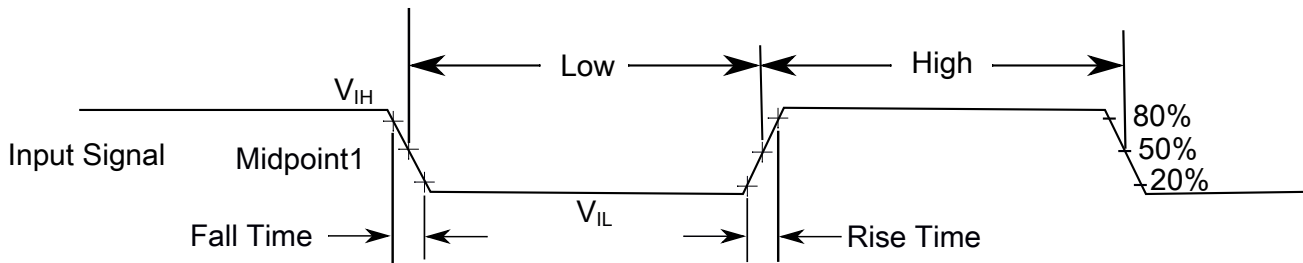

The midpoint is $V_{IL} + (V_{IH} - V_{IL}) / 2$

Figure 2. Input signal measurement reference

All digital I/O switching characteristics, unless otherwise specified, assume the output pins have the following characteristics.

- $C_L=30$ pF loads
- Slew rate disabled
- Normal drive strength

2.2 Nonswitching electrical specifications

2.2.1 Voltage and current operating requirements

Table 5. Voltage and current operating requirements

Symbol	Description	Min.	Max.	Unit	Notes
V_{DD}	Supply voltage	1.71	3.6	V	
V_{DDA}	Analog supply voltage	1.71	3.6	V	—
$V_{DD} - V_{DDA}$	V_{DD} -to- V_{DDA} differential voltage	-0.1	0.1	V	—
$V_{SS} - V_{SSA}$	V_{SS} -to- V_{SSA} differential voltage	-0.1	0.1	V	—
V_{IH}	Input high voltage <ul style="list-style-type: none"> • $2.7\text{ V} \leq V_{DD} \leq 3.6\text{ V}$ • $1.7\text{ V} \leq V_{DD} \leq 2.7\text{ V}$ 	$0.7 \times V_{DD}$ $0.75 \times V_{DD}$	— —	V V	—
V_{IL}	Input low voltage <ul style="list-style-type: none"> • $2.7\text{ V} \leq V_{DD} \leq 3.6\text{ V}$ • $1.7\text{ V} \leq V_{DD} \leq 2.7\text{ V}$ 	— —	$0.35 \times V_{DD}$ $0.3 \times V_{DD}$	V V	—
V_{HYS}	Input hysteresis	$0.06 \times V_{DD}$	—	V	—
I_{ICIO}	IO pin negative DC injection current—single pin <ul style="list-style-type: none"> • $V_{IN} < V_{SS}-0.3\text{V}$ 	-3	—	mA	1
I_{ICcont}	Contiguous pin DC injection current —regional limit, includes sum of negative injection currents of 16 contiguous pins <ul style="list-style-type: none"> • Negative current injection 	-25	—	mA	—
V_{ODPU}	Open drain pullup voltage level	V_{DD}	V_{DD}	V	2
V_{RAM}	V_{DD} voltage required to retain RAM	1.2	—	V	—

1. All I/O pins are internally clamped to V_{SS} through a ESD protection diode. There is no diode connection to V_{DD} . If V_{IN} greater than V_{IO_MIN} ($= V_{SS}-0.3\text{ V}$) is observed, then there is no need to provide current limiting resistors at the pads. If this limit cannot be observed then a current limiting resistor is required. The negative DC injection current limiting resistor is calculated as $R = (V_{IO_MIN} - V_{IN})/|I_{ICIO}|$.
2. Open drain outputs must be pulled to V_{DD} .

2.2.2 LVD and POR operating requirements

Table 6. V_{DD} supply LVD and POR operating requirements

Symbol	Description	Min.	Typ.	Max.	Unit	Notes
V_{POR}	Falling V_{DD} POR detect voltage	0.8	1.1	1.5	V	—
V_{LVDH}	Falling low-voltage detect threshold — high range (LVDV = 01)	2.48	2.56	2.64	V	—
	Low-voltage warning thresholds — high range					1

Table continues on the next page...

Table 6. V_{DD} supply LVD and POR operating requirements (continued)

Symbol	Description	Min.	Typ.	Max.	Unit	Notes
V _{LVW1H}	<ul style="list-style-type: none"> Level 1 falling (LVWV = 00) 	2.62	2.70	2.78	V	
V _{LVW2H}	<ul style="list-style-type: none"> Level 2 falling (LVWV = 01) 	2.72	2.80	2.88	V	
V _{LVW3H}	<ul style="list-style-type: none"> Level 3 falling (LVWV = 10) 	2.82	2.90	2.98	V	
V _{LVW4H}	<ul style="list-style-type: none"> Level 4 falling (LVWV = 11) 	2.92	3.00	3.08	V	
V _{HYSH}	Low-voltage inhibit reset/recover hysteresis — high range	—	±60	—	mV	—
V _{LVDL}	Falling low-voltage detect threshold — low range (LVDV=00)	1.54	1.60	1.66	V	—
V _{LVW1L}	Low-voltage warning thresholds — low range <ul style="list-style-type: none"> Level 1 falling (LVWV = 00) 	1.74	1.80	1.86	V	1
V _{LVW2L}	<ul style="list-style-type: none"> Level 2 falling (LVWV = 01) 	1.84	1.90	1.96	V	
V _{LVW3L}	<ul style="list-style-type: none"> Level 3 falling (LVWV = 10) 	1.94	2.00	2.06	V	
V _{LVW4L}	<ul style="list-style-type: none"> Level 4 falling (LVWV = 11) 	2.04	2.10	2.16	V	
V _{HYSL}	Low-voltage inhibit reset/recover hysteresis — low range	—	±40	—	mV	—
V _{BG}	Bandgap voltage reference	0.97	1.00	1.03	V	—
t _{LPO}	Internal low power oscillator period — factory trimmed	900	1000	1100	µs	—

1. Rising thresholds are falling threshold + hysteresis voltage

2.2.3 Voltage and current operating behaviors

Table 7. Voltage and current operating behaviors

Symbol	Description	Min.	Max.	Unit	Notes
V _{OH}	Output high voltage — Normal drive pad (except RESET) <ul style="list-style-type: none"> 2.7 V ≤ V_{DD} ≤ 3.6 V, I_{OH} = -5 mA 1.71 V ≤ V_{DD} ≤ 2.7 V, I_{OH} = -1.5 mA 	V _{DD} - 0.5 V _{DD} - 0.5	— —	V V	1, 2
V _{OH}	Output high voltage — High drive pad (except RESET) <ul style="list-style-type: none"> 2.7 V ≤ V_{DD} ≤ 3.6 V, I_{OH} = -18 mA 1.71 V ≤ V_{DD} ≤ 2.7 V, I_{OH} = -6 mA 	V _{DD} - 0.5 V _{DD} - 0.5	— —	V V	1, 2
I _{OHT}	Output high current total for all ports	—	100	mA	—
V _{OL}	Output low voltage — Normal drive pad <ul style="list-style-type: none"> 2.7 V ≤ V_{DD} ≤ 3.6 V, I_{OL} = 5 mA 1.71 V ≤ V_{DD} ≤ 2.7 V, I_{OL} = 1.5 mA 	— —	0.5 0.5	V V	1

Table continues on the next page...

Table 7. Voltage and current operating behaviors (continued)

Symbol	Description	Min.	Max.	Unit	Notes
V _{OL}	Output low voltage — High drive pad <ul style="list-style-type: none"> • 2.7 V ≤ V_{DD} ≤ 3.6 V, I_{OL} = 18 mA • 1.71 V ≤ V_{DD} ≤ 2.7 V, I_{OL} = 6 mA 	—	0.5	V	1
		—	0.5	V	
I _{OLT}	Output low current total for all ports	—	100	mA	—
I _{IN}	Input leakage current (per pin) for full temperature range	—	1	μA	3
I _{IN}	Input leakage current (per pin) at 25 °C	—	0.025	μA	3
I _{IN}	Input leakage current (total all pins) for full temperature range	—	65	μA	3
I _{OZ}	Hi-Z (off-state) leakage current (per pin)	—	1	μA	—
R _{PU}	Internal pullup resistors	20	50	kΩ	4
R _{PD}	Internal pulldown resistors	20	50	kΩ	5

1. PTB0, PTB1, PTD6, and PTD7 I/O have both high drive and normal drive capability selected by the associated PTx_PCRn[DSE] control bit. All other GPIOs are normal drive only.
2. The reset pin only contains an active pull down device when configured as the RESET signal or as a GPIO. When configured as a GPIO output, it acts as a pseudo open drain output.
3. Measured at V_{DD} = 3.6 V
4. Measured at V_{DD} supply voltage = V_{DD} min and V_{input} = V_{SS}
5. Measured at VDD supply voltage = VDD min and V_{input} = VDD

2.2.4 Power mode transition operating behaviors

All specifications except t_{POR} and VLLSx→RUN recovery times in the following table assume this clock configuration:

- CPU and system clocks = 48 MHz
- Bus and flash clock = 24 MHz
- FEI clock mode

POR and VLLSx→RUN recovery use FEI clock mode at the default CPU and system frequency of 21 MHz, and a bus and flash clock frequency of 10.5 MHz.

Table 8. Power mode transition operating behaviors

Symbol	Description	Min.	Typ.	Max.	Unit	
t _{POR}	After a POR event, amount of time from the point V _{DD} reaches 1.8 V to execution of the first instruction across the operating temperature range of the chip.	—	—	300	μs	1
	• VLLS0 → RUN	—	95	115	μs	

Table continues on the next page...

Table 8. Power mode transition operating behaviors (continued)

Symbol	Description	Min.	Typ.	Max.	Unit	
	• VLLS1 → RUN	—	93	115	μs	
	• VLLS3 → RUN	—	42	53	μs	
	• LLS → RUN	—	4	4.6	μs	
	• VLPS → RUN	—	4	4.4	μs	
	• STOP → RUN	—	4	4.4	μs	

1. Normal boot (FTFA_FOPT[LPBOOT]=11).

2.2.5 Power consumption operating behaviors

The maximum values stated in the following table represent characterized results equivalent to the mean plus three times the standard deviation (mean + 3 sigma).

Table 9. Power consumption operating behaviors

Symbol	Description	Temp.	Typ.	Max	Unit	Note
I _{DDA}	Analog supply current	—	—	See note	mA	1
I _{DD_RUNCO_CM}	Run mode current in compute operation - 48 MHz core / 24 MHz flash/ bus disabled, LPTMR running using 4 MHz internal reference clock, CoreMark® benchmark code executing from flash, at 3.0 V	—	6.4	—	mA	2
I _{DD_RUNCO}	Run mode current in compute operation - 48 MHz core / 24 MHz flash / bus clock disabled, code of while(1) loop executing from flash, at 3.0 V	—	3.9	4.8	mA	3
I _{DD_RUN}	Run mode current - 48 MHz core / 24 MHz bus and flash, all peripheral clocks disabled, code executing from flash, at 3.0 V	—	5	5.9	mA	3
I _{DD_RUN}	Run mode current - 48 MHz core / 24 MHz bus and flash, all peripheral clocks enabled, code executing from flash, at 3.0 V	at 25 °C	6.2	6.5	mA	3, 4
		at 125 °C	6.8	7.1	mA	

Table continues on the next page...

Table 9. Power consumption operating behaviors (continued)

Symbol	Description	Temp.	Typ.	Max	Unit	Note
I _{DD_WAIT}	Wait mode current - core disabled / 48 MHz system / 24 MHz bus / flash disabled (flash doze enabled), all peripheral clocks disabled, at 3.0 V	—	3.1	3.8	mA	3
I _{DD_WAIT}	Wait mode current - core disabled / 24 MHz system / 24 MHz bus / flash disabled (flash doze enabled), all peripheral clocks disabled • at 3.0 V	—	2.4	3.2	mA	3
I _{DD_PSTOP2}	Stop mode current with partial stop 2 clocking option - core and system disabled / 10.5 MHz bus, at 3.0 V	—	1.6	2	mA	3
I _{DD_VLPRCO_CM}	Very-low-power run mode current in compute operation - 4 MHz core / 0.8 MHz flash / bus clock disabled, LPTMR running with 4 MHz internal reference clock, CoreMark benchmark code executing from flash, at 3.0 V	—	777	—	μA	5
I _{DD_VLPRCO}	Very low power run mode current in compute operation - 4 MHz core / 0.8 MHz flash / bus clock disabled, code executing from flash, at 3.0 V	—	171	420	μA	6
I _{DD_VLPR}	Very low power run mode current - 4 MHz core / 0.8 MHz bus and flash, all peripheral clocks disabled, code executing from flash, at 3.0 V	—	204	449	μA	6
I _{DD_VLPR}	Very low power run mode current - 4 MHz core / 0.8 MHz bus and flash, all peripheral clocks enabled, code executing from flash, at 3.0 V	—	262	509	μA	4, 6
I _{DD_VLPW}	Very low power wait mode current - core disabled / 4 MHz system / 0.8 MHz bus / flash disabled (flash doze enabled), all peripheral clocks disabled, at 3.0 V	—	123	366	μA	6
I _{DD_STOP}	Stop mode current at 3.0 V	at 25 °C	319	343	μA	—
		at 50 °C	333	365	μA	
		at 70 °C	353	400	μA	
		at 85 °C	380	450	μA	
		at 105 °C	444	572	μA	
I _{DD_VLPS}	Very-low-power stop mode current at 3.0 V	at 25 °C	3.75	8.46	μA	—
		at 50 °C	6.66	13.41	μA	
		at 70 °C	12.9	25.71	μA	
		at 85 °C	22.7	44.06	μA	
		at 105 °C	48.4	90.1	μA	
I _{DD_LLS}	Low leakage stop mode current at 3.0 V	at 25 °C	1.68	2.09	μA	—
		at 50 °C	3.05	4.04	μA	

Table continues on the next page...

Table 9. Power consumption operating behaviors (continued)

Symbol	Description	Temp.	Typ.	Max	Unit	Note
		at 70 °C	5.71	7.75	μA	
		at 85 °C	10	13.54	μA	
		at 105 °C	22.4	30.41	μA	
I _{DD_VLLS3}	Very low-leakage stop mode 3 current at 3.0 V	at 25 °C	1.22	1.6	μA	—
		at 50 °C	2.25	2.31	μA	
		at 70 °C	4.21	5.44	μA	
		at 85 °C	7.37	9.44	μA	
		at 105 °C	16.6	21.76	μA	
I _{DD_VLLS1}	Very low-leakage stop mode 1 current at 3.0 V	at 25 °C	0.58	0.94	μA	—
		at 50 °C	1.26	1.31	μA	
		at 70 °C	2.53	3.33	μA	
		at 85 °C	4.74	6.1	μA	
		at 105 °C	11.4	15.27	μA	
I _{DD_VLLS0}	Very low-leakage stop mode 0 current (SMC_STOPCTRL[PORPO] = 0) at 3.0 V	at 25 °C	0.31	0.65	μA	—
		at 50 °C	0.99	1.43	μA	
		at 70 °C	2.25	3.01	μA	
		at 85 °C	4.46	5.83	μA	
		at 105 °C	11.13	14.99	μA	
I _{DD_VLLS0}	Very low-leakage stop mode 0 current (SMC_STOPCTRL[PORPO] = 1) at 3.0 V	at 25 °C	0.12	0.47	μA	7
		at 50 °C	0.8	1.24	μA	
		at 70 °C	2.06	2.81	μA	
		at 85 °C	4.27	5.62	μA	
		at 105 °C	10.93	14.78	μA	

1. The analog supply current is the sum of the active or disabled current for each of the analog modules on the device. See each module's specification for its supply current.
2. MCG configured for PEE mode. CoreMark benchmark compiled using Keil 4.54 with optimization level 3, optimized for time.
3. MCG configured for FEI mode.
4. Incremental current consumption from peripheral activity is not included.
5. MCG configured for BLPI mode. CoreMark benchmark compiled using IAR 6.40 with optimization level high, optimized for balanced.
6. MCG configured for BLPI mode.
7. No brownout.

Table 10. Low power mode peripheral adders — typical value

Symbol	Description	Temperature (°C)						Unit
		-40	25	50	70	85	105	
I _{REFSTEN4MHz}	4 MHz internal reference clock (IRC) adder. Measured by entering STOP or VLPS mode with 4 MHz IRC enabled.	56	56	56	56	56	56	μA

Table continues on the next page...

Table 10. Low power mode peripheral adders — typical value (continued)

Symbol	Description	Temperature (°C)						Unit	
		-40	25	50	70	85	105		
I _{IREFSTEN32KHz}	32 kHz internal reference clock (IRC) adder. Measured by entering STOP mode with the 32 kHz IRC enabled.	52	52	52	52	52	52	μA	
I _{EREFSTEN4MHz}	External 4 MHz crystal clock adder. Measured by entering STOP or VLPS mode with the crystal enabled.	206	228	237	245	251	258	μA	
I _{EREFSTEN32KHz}	External 32 kHz crystal clock adder by means of the OSC0_CR[EREFSTEN and EREFSTEN] bits. Measured by entering all modes with the crystal enabled.	VLLS1	440	490	540	560	570	580	nA
		VLLS3	440	490	540	560	570	580	
		LLS	490	490	540	560	570	680	
		VLPS	510	560	560	560	610	680	
		STOP	510	560	560	560	610	680	
I _{CMP}	CMP peripheral adder measured by placing the device in VLLS1 mode with CMP enabled using the 6-bit DAC and a single external input for compare. Includes 6-bit DAC power consumption.	22	22	22	22	22	22	μA	
I _{RTC}	RTC peripheral adder measured by placing the device in VLLS1 mode with external 32 kHz crystal enabled by means of the RTC_CR[OSCE] bit and the RTC ALARM set for 1 minute. Includes ERCLK32K (32 kHz external crystal) power consumption.	432	357	388	475	532	810	nA	
I _{UART}	UART peripheral adder measured by placing the device in STOP or VLPS mode with selected clock source waiting for RX data at 115200 baud rate. Includes selected clock source power consumption.	MCGIRCLK (4 MHz internal reference clock)	66	66	66	66	66	66	μA
		OSCERCLK (4 MHz external crystal)	214	237	246	254	260	268	
I _{TPM}	TPM peripheral adder measured by placing the device in STOP or VLPS mode with selected clock source configured for output compare generating 100 Hz clock signal. No load is placed on the I/O generating the clock signal. Includes selected clock source and I/O switching currents.	MCGIRCLK (4 MHz internal reference clock)	86	86	86	86	86	86	μA
		OSCERCLK (4 MHz external crystal)	235	256	265	274	280	287	
I _{BG}	Bandgap adder when BGEN bit is set and device is placed in VLPx, LLS, or VLLSx mode.	45	45	45	45	45	45	μA	
I _{ADC}	ADC peripheral adder combining the measured values at V _{DD} and V _{DDA} by placing	366	366	366	366	366	366	μA	

Table 10. Low power mode peripheral adders — typical value

Symbol	Description	Temperature (°C)						Unit
		-40	25	50	70	85	105	
	the device in STOP or VLPS mode. ADC is configured for low power mode using the internal clock and continuous conversions.							

2.2.5.1 Diagram: Typical IDD_RUN operating behavior

The following data was measured under these conditions:

- MCG in FBE for run mode, and BLPE for VLPR mode
- No GPIOs toggled
- Code execution from flash with cache enabled
- For the ALLOFF curve, all peripheral clocks are disabled except FTFA

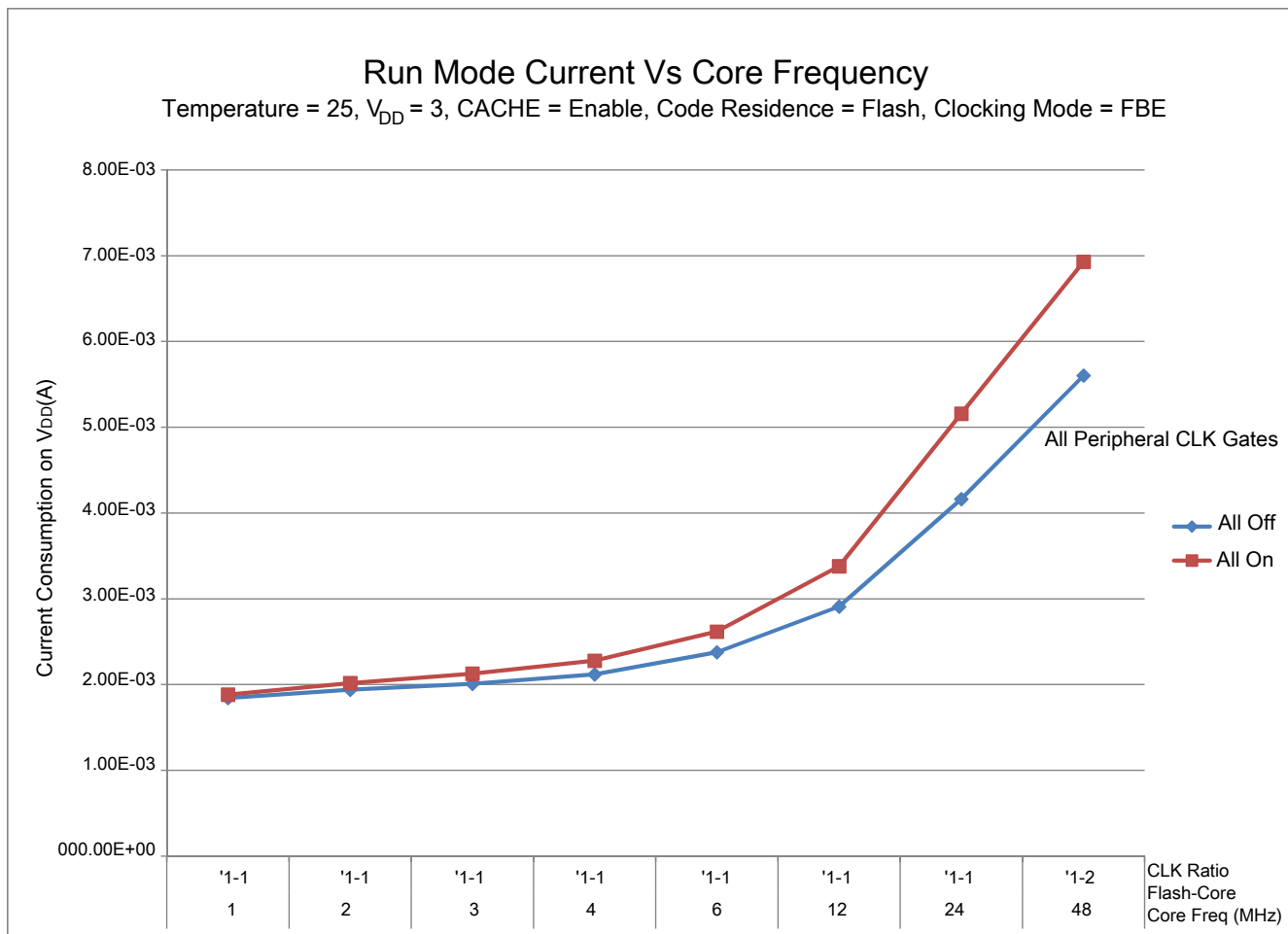

Figure 3. Run mode supply current vs. core frequency

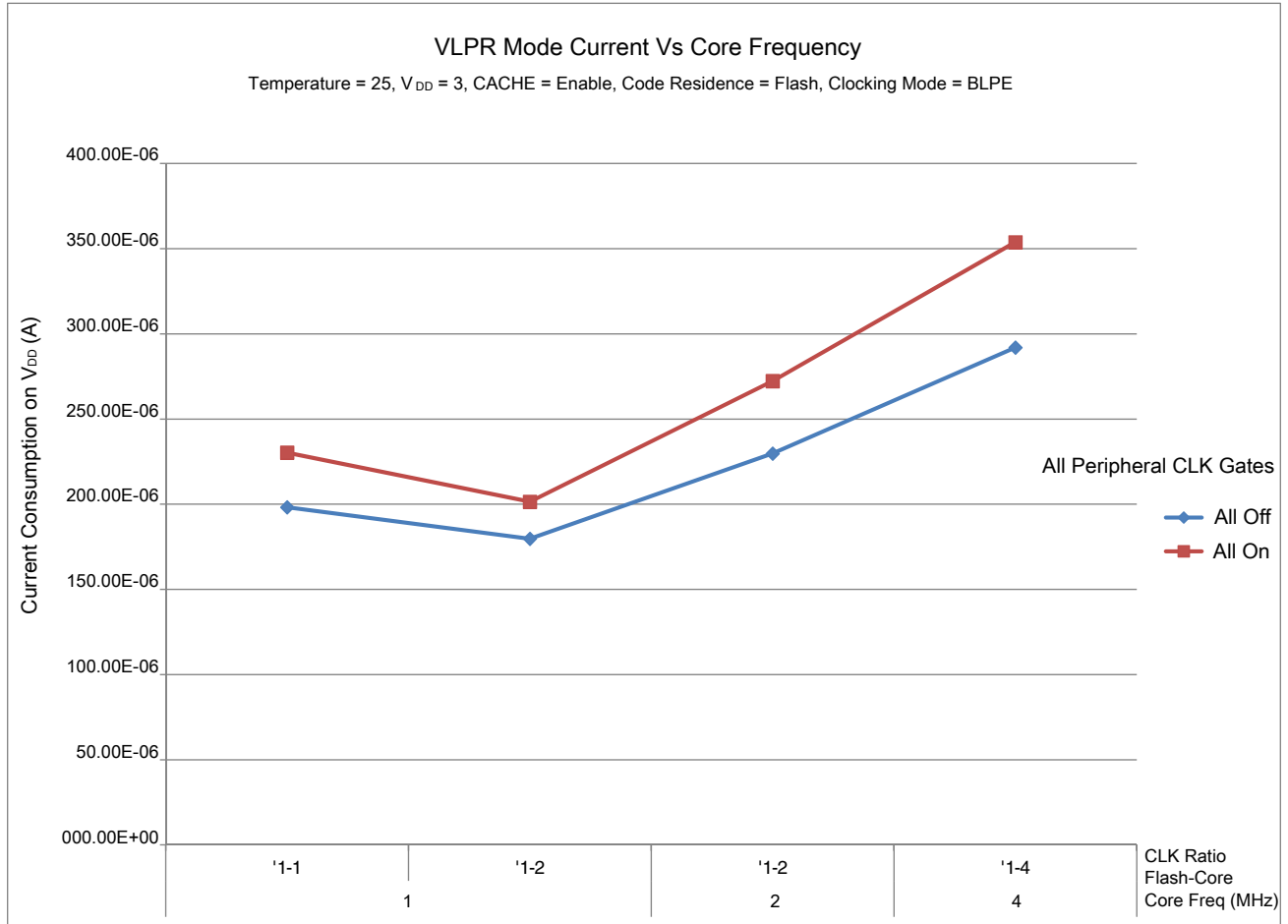

Figure 4. VLPR mode current vs. core frequency

2.2.6 EMC radiated emissions operating behaviors

Table 11. EMC radiated emissions operating behaviors for 64-pin LQFP package

Symbol	Description	Frequency band (MHz)	Typ.	Unit	Notes
V _{RE1}	Radiated emissions voltage, band 1	0.15–50	13	dBμV	1, 2
V _{RE2}	Radiated emissions voltage, band 2	50–150	15	dBμV	
V _{RE3}	Radiated emissions voltage, band 3	150–500	12	dBμV	
V _{RE4}	Radiated emissions voltage, band 4	500–1000	7	dBμV	
V _{RE_IEC}	IEC level	0.15–1000	M	—	2, 3

1. Determined according to IEC Standard 61967-1, *Integrated Circuits - Measurement of Electromagnetic Emissions, 150 kHz to 1 GHz Part 1: General Conditions and Definitions* and IEC Standard 61967-2, *Integrated Circuits - Measurement of Electromagnetic Emissions, 150 kHz to 1 GHz Part 2: Measurement of Radiated Emissions—TEM Cell and Wideband TEM Cell Method*. Measurements were made while the microcontroller was running basic

General

application code. The reported emission level is the value of the maximum measured emission, rounded up to the next whole number, from among the measured orientations in each frequency range.

2. $V_{DD} = 3.3\text{ V}$, $T_A = 25\text{ }^\circ\text{C}$, $f_{OSC} = 8\text{ MHz}$ (crystal), $f_{SYS} = 48\text{ MHz}$, $f_{BUS} = 48\text{ MHz}$
3. Specified according to Annex D of IEC Standard 61967-2, *Measurement of Radiated Emissions—TEM Cell and Wideband TEM Cell Method*

2.2.7 Designing with radiated emissions in mind

To find application notes that provide guidance on designing your system to minimize interference from radiated emissions:

1. Go to www.freescale.com.
2. Perform a keyword search for “EMC design.”

2.2.8 Capacitance attributes

Table 12. Capacitance attributes

Symbol	Description	Min.	Max.	Unit
C_{IN}	Input capacitance	—	7	pF

2.3 Switching specifications

2.3.1 Device clock specifications

Table 13. Device clock specifications

Symbol	Description	Min.	Max.	Unit
Normal run mode				
f_{SYS}	System and core clock	—	48	MHz
f_{BUS}	Bus clock	—	24	MHz
f_{FLASH}	Flash clock	—	24	MHz
f_{LPTMR}	LPTMR clock	—	24	MHz
VLPR and VLPS modes ¹				
f_{SYS}	System and core clock	—	4	MHz
f_{BUS}	Bus clock	—	1	MHz
f_{FLASH}	Flash clock	—	1	MHz
f_{LPTMR}	LPTMR clock ²	—	24	MHz
f_{ERCLK}	External reference clock	—	16	MHz

Table continues on the next page...

Table 13. Device clock specifications (continued)

Symbol	Description	Min.	Max.	Unit
f _{LPTMR_ERCLK}	LPTMR external reference clock	—	16	MHz
f _{osc_hi_2}	Oscillator crystal or resonator frequency — high frequency mode (high range) (MCG_C2[RANGE]=1x)	—	16	MHz
f _{TPM}	TPM asynchronous clock	—	8	MHz
f _{UART0}	UART0 asynchronous clock	—	8	MHz

1. The frequency limitations in VLPR and VLPS modes here override any frequency specification listed in the timing specification for any other module. These same frequency limits apply to VLPS, whether VLPS was entered from RUN or from VLPR.
2. The LPTMR can be clocked at this speed in VLPR or VLPS only when the source is an external pin.

2.3.2 General switching specifications

These general-purpose specifications apply to all signals configured for GPIO and UART signals.

Table 14. General switching specifications

Description	Min.	Max.	Unit	Notes
GPIO pin interrupt pulse width (digital glitch filter disabled) — Synchronous path	1.5	—	Bus clock cycles	1
External RESET and NMI pin interrupt pulse width — Asynchronous path	100	—	ns	2
GPIO pin interrupt pulse width — Asynchronous path	16	—	ns	2
Port rise and fall time	—	36	ns	3

1. The greater synchronous and asynchronous timing must be met.
2. This is the shortest pulse that is guaranteed to be recognized.
3. 75 pF load

2.4 Thermal specifications

2.4.1 Thermal operating requirements

Table 15. Thermal operating requirements

Symbol	Description	Min.	Max.	Unit
T _J	Die junction temperature	−40	125	°C
T _A	Ambient temperature	−40	105	°C

2.4.2 Thermal attributes

Table 16. Thermal attributes

Board type	Symbol	Description	80 LQFP	64 LQFP	48 QFN	32 QFN	Unit	Notes
Single-layer (1S)	$R_{\theta JA}$	Thermal resistance, junction to ambient (natural convection)	70	71	84	92	°C/W	1
Four-layer (2s2p)	$R_{\theta JA}$	Thermal resistance, junction to ambient (natural convection)	53	52	28	33	°C/W	
Single-layer (1S)	$R_{\theta JMA}$	Thermal resistance, junction to ambient (200 ft./min. air speed)	—	59	69	75	°C/W	
Four-layer (2s2p)	$R_{\theta JMA}$	Thermal resistance, junction to ambient (200 ft./min. air speed)	—	46	22	27	°C/W	
—	$R_{\theta JB}$	Thermal resistance, junction to board	34	34	10	12	°C/W	2
—	$R_{\theta JC}$	Thermal resistance, junction to case	15	20	2.0	1.8	°C/W	3
—	Ψ_{JT}	Thermal characterization parameter, junction to package top outside center (natural convection)	0.6	5	5.0	8	°C/W	4

1. Determined according to JEDEC Standard JESD51-2, *Integrated Circuits Thermal Test Method Environmental Conditions—Natural Convection (Still Air)*, or EIA/JEDEC Standard JESD51-6, *Integrated Circuit Thermal Test Method Environmental Conditions—Forced Convection (Moving Air)*.
2. Determined according to JEDEC Standard JESD51-8, *Integrated Circuit Thermal Test Method Environmental Conditions—Junction-to-Board*.
3. Determined according to Method 1012.1 of MIL-STD 883, *Test Method Standard, Microcircuits*, with the cold plate temperature used for the case temperature. The value includes the thermal resistance of the interface material between the top of the package and the cold plate.
4. Determined according to JEDEC Standard JESD51-2, *Integrated Circuits Thermal Test Method Environmental Conditions—Natural Convection (Still Air)*.

3 Peripheral operating requirements and behaviors

3.1 Core modules

3.1.1 SWD electricals

Table 17. SWD full voltage range electricals

Symbol	Description	Min.	Max.	Unit
	Operating voltage	1.71	3.6	V
J1	SWD_CLK frequency of operation <ul style="list-style-type: none"> Serial wire debug 	0	25	MHz
J2	SWD_CLK cycle period	1/J1	—	ns
J3	SWD_CLK clock pulse width <ul style="list-style-type: none"> Serial wire debug 	20	—	ns
J4	SWD_CLK rise and fall times	—	3	ns
J9	SWD_DIO input data setup time to SWD_CLK rise	10	—	ns
J10	SWD_DIO input data hold time after SWD_CLK rise	0	—	ns
J11	SWD_CLK high to SWD_DIO data valid	—	32	ns
J12	SWD_CLK high to SWD_DIO high-Z	5	—	ns

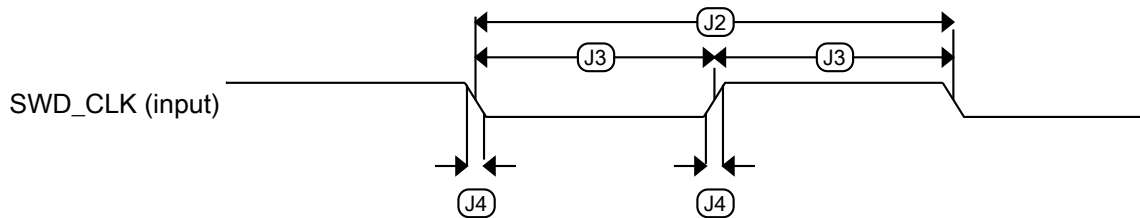

Figure 5. Serial wire clock input timing

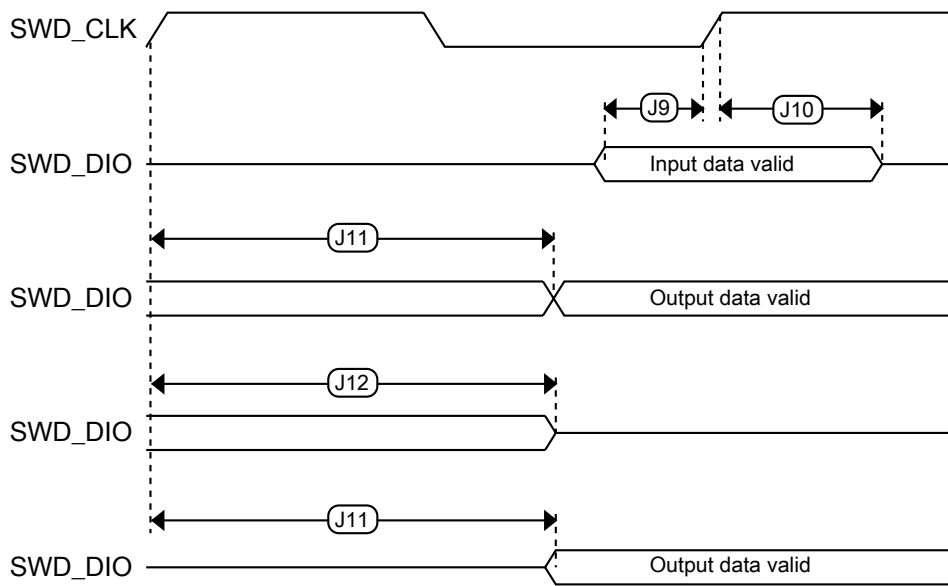

Figure 6. Serial wire data timing

3.2 System modules

There are no specifications necessary for the device's system modules.

3.3 Clock modules

3.3.1 MCG specifications

Table 18. MCG specifications

Symbol	Description	Min.	Typ.	Max.	Unit	Notes
f_{ints_ft}	Internal reference frequency (slow clock) — factory trimmed at nominal V_{DD} and 25 °C	—	32.768	—	kHz	
f_{ints_t}	Internal reference frequency (slow clock) — user trimmed	31.25	—	39.0625	kHz	
$\Delta_{f_{dco_res_t}}$	Resolution of trimmed average DCO output frequency at fixed voltage and temperature — using C3[SCTTRIM] and C4[SCFTRIM]	—	± 0.3	± 0.6	% f_{dco}	1

Table continues on the next page...

Table 18. MCG specifications (continued)

Symbol	Description	Min.	Typ.	Max.	Unit	Notes	
Δf_{dco_t}	Total deviation of trimmed average DCO output frequency over voltage and temperature	—	+0.5/-0.7	± 3	% f_{dco}	1, 2	
Δf_{dco_t}	Total deviation of trimmed average DCO output frequency over fixed voltage and temperature range of 0–70 °C	—	± 0.4	± 1.5	% f_{dco}	1, 2	
f_{intf_ft}	Internal reference frequency (fast clock) — factory trimmed at nominal V_{DD} and 25 °C	—	4	—	MHz		
Δf_{intf_ft}	Frequency deviation of internal reference clock (fast clock) over temperature and voltage — factory trimmed at nominal V_{DD} and 25 °C	—	+1/-2	± 3	% f_{intf_ft}	2	
f_{intf_t}	Internal reference frequency (fast clock) — user trimmed at nominal V_{DD} and 25 °C	3	—	5	MHz		
f_{loc_low}	Loss of external clock minimum frequency — RANGE = 00	$(3/5) \times f_{ints_t}$	—	—	kHz		
f_{loc_high}	Loss of external clock minimum frequency — RANGE = 01, 10, or 11	$(16/5) \times f_{ints_t}$	—	—	kHz		
FLL							
f_{fill_ref}	FLL reference frequency range	31.25	—	39.0625	kHz		
f_{dco}	DCO output frequency range	Low range (DRS = 00) $640 \times f_{fill_ref}$	20	20.97	25	MHz	3, 4
		Mid range (DRS = 01) $1280 \times f_{fill_ref}$	40	41.94	48	MHz	
$f_{dco_t_DMX3_2}$	DCO output frequency	Low range (DRS = 00) $732 \times f_{fill_ref}$	—	23.99	—	MHz	5, 6
		Mid range (DRS = 01) $1464 \times f_{fill_ref}$	—	47.97	—	MHz	
J_{cyc_fll}	FLL period jitter • $f_{VCO} = 48$ MHz	—	180	—	ps	7	
$t_{fll_acquire}$	FLL target frequency acquisition time	—	—	1	ms	8	
PLL							
f_{vco}	VCO operating frequency	48.0	—	100	MHz		
I_{pll}	PLL operating current • PLL at 96 MHz ($f_{osc_hi_1} = 8$ MHz, $f_{pll_ref} = 2$ MHz, VDIV multiplier = 48)	—	1060	—	μ A	9	
I_{pll}	PLL operating current • PLL at 48 MHz ($f_{osc_hi_1} = 8$ MHz, $f_{pll_ref} = 2$ MHz, VDIV multiplier = 24)	—	600	—	μ A	9	
f_{pll_ref}	PLL reference frequency range	2.0	—	4.0	MHz		
J_{cyc_pll}	PLL period jitter (RMS) • $f_{vco} = 48$ MHz • $f_{vco} = 100$ MHz	—	120	—	ps	10	
		—	50	—	ps		

Table continues on the next page...

Table 18. MCG specifications (continued)

Symbol	Description	Min.	Typ.	Max.	Unit	Notes
J _{acc_pll}	PLL accumulated jitter over 1μs (RMS) <ul style="list-style-type: none"> f_{VCO} = 48 MHz f_{VCO} = 100 MHz 	—	1350	—	ps	10
		—	600	—	ps	
D _{lock}	Lock entry frequency tolerance	± 1.49	—	± 2.98	%	
D _{unl}	Lock exit frequency tolerance	± 4.47	—	± 5.97	%	
t _{pll_lock}	Lock detector detection time	—	—	150 × 10 ⁻⁶ + 1075(1/ f _{pll_ref})	s	11

1. This parameter is measured with the internal reference (slow clock) being used as a reference to the FLL (FEI clock mode).
2. The deviation is relative to the factory trimmed frequency at nominal V_{DD} and 25 °C, f_{ints_ft}.
3. These typical values listed are with the slow internal reference clock (FEI) using factory trim and DMX32 = 0.
4. The resulting system clock frequencies must not exceed their maximum specified values. The DCO frequency deviation (Δf_{dco_t}) over voltage and temperature must be considered.
5. These typical values listed are with the slow internal reference clock (FEI) using factory trim and DMX32 = 1.
6. The resulting clock frequency must not exceed the maximum specified clock frequency of the device.
7. This specification is based on standard deviation (RMS) of period or frequency.
8. This specification applies to any time the FLL reference source or reference divider is changed, trim value is changed, DMX32 bit is changed, DRS bits are changed, or changing from FLL disabled (BLPE, BLPI) to FLL enabled (FEI, FEE, FBE, FBI). If a crystal/resonator is being used as the reference, this specification assumes it is already running.
9. Excludes any oscillator currents that are also consuming power while PLL is in operation.
10. This specification was obtained using a Freescale developed PCB. PLL jitter is dependent on the noise characteristics of each PCB and results will vary.
11. This specification applies to any time the PLL VCO divider or reference divider is changed, or changing from PLL disabled (BLPE, BLPI) to PLL enabled (PBE, PEE). If a crystal/resonator is being used as the reference, this specification assumes it is already running.

3.3.2 Oscillator electrical specifications

3.3.2.1 Oscillator DC electrical specifications

Table 19. Oscillator DC electrical specifications

Symbol	Description	Min.	Typ.	Max.	Unit	Notes
V _{DD}	Supply voltage	1.71	—	3.6	V	
I _{DDOSC}	Supply current — low-power mode (HGO=0) <ul style="list-style-type: none"> 32 kHz 4 MHz 8 MHz (RANGE=01) 16 MHz 	—	500	—	nA	1
		—	200	—	μA	
		—	300	—	μA	
		—	950	—	μA	
		—	1.2	—	mA	

Table continues on the next page...

Table 19. Oscillator DC electrical specifications (continued)

Symbol	Description	Min.	Typ.	Max.	Unit	Notes
	<ul style="list-style-type: none"> • 24 MHz • 32 MHz 	—	1.5	—	mA	
I_{DDOSC}	Supply current — high gain mode (HGO=1) <ul style="list-style-type: none"> • 32 kHz • 4 MHz • 8 MHz (RANGE=01) • 16 MHz • 24 MHz • 32 MHz 	—	25	—	μ A	1
		—	400	—	μ A	
		—	500	—	μ A	
		—	2.5	—	mA	
		—	3	—	mA	
		—	4	—	mA	
C_x	EXTAL load capacitance	—	—	—		2, 3
C_y	XTAL load capacitance	—	—	—		2, 3
R_F	Feedback resistor — low-frequency, low-power mode (HGO=0)	—	—	—	M Ω	2, 4
	Feedback resistor — low-frequency, high-gain mode (HGO=1)	—	10	—	M Ω	
	Feedback resistor — high-frequency, low-power mode (HGO=0)	—	—	—	M Ω	
	Feedback resistor — high-frequency, high-gain mode (HGO=1)	—	1	—	M Ω	
R_S	Series resistor — low-frequency, low-power mode (HGO=0)	—	—	—	k Ω	
	Series resistor — low-frequency, high-gain mode (HGO=1)	—	200	—	k Ω	
	Series resistor — high-frequency, low-power mode (HGO=0)	—	—	—	k Ω	
	Series resistor — high-frequency, high-gain mode (HGO=1)	—	0	—	k Ω	
V_{pp}^5	Peak-to-peak amplitude of oscillation (oscillator mode) — low-frequency, low-power mode (HGO=0)	—	0.6	—	V	
	Peak-to-peak amplitude of oscillation (oscillator mode) — low-frequency, high-gain mode (HGO=1)	—	V_{DD}	—	V	
	Peak-to-peak amplitude of oscillation (oscillator mode) — high-frequency, low-power mode (HGO=0)	—	0.6	—	V	
	Peak-to-peak amplitude of oscillation (oscillator mode) — high-frequency, high-gain mode (HGO=1)	—	V_{DD}	—	V	

 1. $V_{DD}=3.3$ V, Temperature =25 °C

2. See crystal or resonator manufacturer's recommendation

Peripheral operating requirements and behaviors

- C_x, C_y can be provided by using the integrated capacitors when the low frequency oscillator (RANGE = 00) is used. For all other cases external capacitors must be used.
- When low power mode is selected, R_f is integrated and must not be attached externally.
- The EXTAL and XTAL pins should only be connected to required oscillator components and must not be connected to any other devices.

3.3.2.2 Oscillator frequency specifications

Table 20. Oscillator frequency specifications

Symbol	Description	Min.	Typ.	Max.	Unit	Notes
f_{osc_lo}	Oscillator crystal or resonator frequency — low-frequency mode (MCG_C2[RANGE]=00)	32	—	40	kHz	
$f_{osc_hi_1}$	Oscillator crystal or resonator frequency — high-frequency mode (low range) (MCG_C2[RANGE]=01)	3	—	8	MHz	
$f_{osc_hi_2}$	Oscillator crystal or resonator frequency — high-frequency mode (high range) (MCG_C2[RANGE]=1x)	8	—	32	MHz	
f_{ec_extal}	Input clock frequency (external clock mode)	—	—	48	MHz	1, 2
t_{dc_extal}	Input clock duty cycle (external clock mode)	40	50	60	%	
t_{cst}	Crystal startup time — 32 kHz low-frequency, low-power mode (HGO=0)	—	750	—	ms	3, 4
	Crystal startup time — 32 kHz low-frequency, high-gain mode (HGO=1)	—	250	—	ms	
	Crystal startup time — 8 MHz high-frequency (MCG_C2[RANGE]=01), low-power mode (HGO=0)	—	0.6	—	ms	
	Crystal startup time — 8 MHz high-frequency (MCG_C2[RANGE]=01), high-gain mode (HGO=1)	—	1	—	ms	

- Other frequency limits may apply when external clock is being used as a reference for the FLL.
- When transitioning from FEI or FBI to FBE mode, restrict the frequency of the input clock so that, when it is divided by FRDIV, it remains within the limits of the DCO input clock frequency.
- Proper PC board layout procedures must be followed to achieve specifications.
- Crystal startup time is defined as the time between the oscillator being enabled and the OSCINIT bit in the MCG_S register being set.

3.4 Memories and memory interfaces

3.4.1 Flash electrical specifications

This section describes the electrical characteristics of the flash memory module.

3.4.1.1 Flash timing specifications — program and erase

The following specifications represent the amount of time the internal charge pumps are active and do not include command overhead.

Table 21. NVM program/erase timing specifications

Symbol	Description	Min.	Typ.	Max.	Unit	Notes
t_{hvpgm4}	Longword Program high-voltage time	—	7.5	18	μ s	—
$t_{hversscr}$	Sector Erase high-voltage time	—	13	113	ms	1
$t_{hversall}$	Erase All high-voltage time	—	52	452	ms	1

1. Maximum time based on expectations at cycling end-of-life.

3.4.1.2 Flash timing specifications — commands

Table 22. Flash command timing specifications

Symbol	Description	Min.	Typ.	Max.	Unit	Notes
$t_{rd1sec1k}$	Read 1s Section execution time (flash sector)	—	—	60	μ s	1
t_{pgmchk}	Program Check execution time	—	—	45	μ s	1
t_{rdsrc}	Read Resource execution time	—	—	30	μ s	1
t_{pgm4}	Program Longword execution time	—	65	145	μ s	—
t_{ersscr}	Erase Flash Sector execution time	—	14	114	ms	2
t_{rd1all}	Read 1s All Blocks execution time	—	—	1.8	ms	—
t_{rdonce}	Read Once execution time	—	—	25	μ s	1
$t_{pgmonce}$	Program Once execution time	—	65	—	μ s	—
t_{ersall}	Erase All Blocks execution time	—	88	650	ms	2
t_{vfykey}	Verify Backdoor Access Key execution time	—	—	30	μ s	1

1. Assumes 25 MHz flash clock frequency.
2. Maximum times for erase parameters based on expectations at cycling end-of-life.

3.4.1.3 Flash high voltage current behaviors

Table 23. Flash high voltage current behaviors

Symbol	Description	Min.	Typ.	Max.	Unit
I_{DD_PGM}	Average current adder during high voltage flash programming operation	—	2.5	6.0	mA
I_{DD_ERS}	Average current adder during high voltage flash erase operation	—	1.5	4.0	mA