



Chipsmall Limited consists of a professional team with an average of over 10 year of expertise in the distribution of electronic components. Based in Hongkong, we have already established firm and mutual-benefit business relationships with customers from,Europe,America and south Asia,supplying obsolete and hard-to-find components to meet their specific needs.

With the principle of “Quality Parts,Customers Priority,Honest Operation,and Considerate Service”,our business mainly focus on the distribution of electronic components. Line cards we deal with include Microchip,ALPS,ROHM,Xilinx,Pulse,ON,Everlight and Freescale. Main products comprise IC,Modules,Potentiometer,IC Socket,Relay,Connector.Our parts cover such applications as commercial,industrial, and automotives areas.

We are looking forward to setting up business relationship with you and hope to provide you with the best service and solution. Let us make a better world for our industry!



## Contact us

Tel: +86-755-8981 8866 Fax: +86-755-8427 6832

Email & Skype: info@chipsmall.com Web: www.chipsmall.com

Address: A1208, Overseas Decoration Building, #122 Zhenhua RD., Futian, Shenzhen, China



### Features and Benefits

- Micropower consumption ideal for battery-powered applications
- Omnipolar, easy to use as output switches with both North and South pole
- Very High Sensitivity Hall Sensor
- Chopper stabilized amplifier stage
- Open-Drain Output
- Operation down to 1.5V
- Ultra-Thin QFN package (0.43mm max) & Thin SOT23 3L (both RoHS Compliant)

### Application Examples

- Solid State Switch
- Handheld Wireless Handset Awake Switch
- Lid close sensor for battery-powered devices
- Magnet proximity sensor for reed switch replacement in low duty cycle applications

### Ordering Code

Product Code	Temperature Code	Package Code	Option Code	Packing Form Code
MLX90248	E	SE	EBA-000	RE
MLX90248	E	LD	EBA-000	RE

#### Legend:

Temperature Code:	E for Temperature Range -40°C to 85°C
Package Code:	SE for TSOT, LD for UTQFN
Packing Form:	RE for Reel

Ordering example: MLX90248ESE-EBA-000-RE

### 1 Functional Diagram

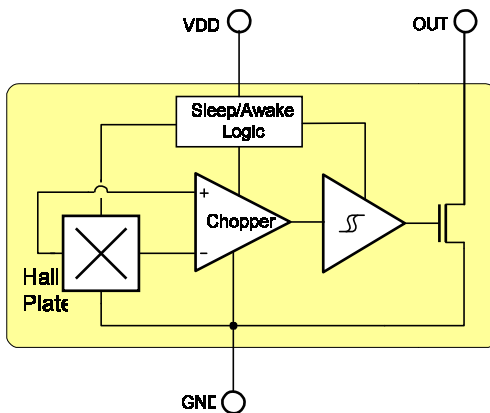

### 2 General Description

The MLX90248 Omnipolar™ Hall effect sensor IC is fabricated from mixed signal CMOS technology. It incorporates advanced chopper-stabilization techniques to provide accurate and stable magnetic switch points.

The circuit design provides an internally controlled clocking mechanism to cycle power to the Hall element and analog signal processing circuits. This serves to place the high current-consuming portions of the circuit into a “Sleep” mode. Periodically the device is “Awakened” by this internal logic and the magnetic flux from the Hall element is evaluated against the predefined thresholds. If the flux density is above or below the Bop/Brp thresholds then the output transistor is driven to change states accordingly. While in the “Sleep” cycle the output transistor is latched in its previous state. The design has been optimized for service in applications requiring extended operating lifetime in battery powered systems.

The output transistor of the 90248 will be latched on (BOP) in the presence of a sufficiently strong South or North magnetic field facing the marked side of the package. The output will be latched off (BRP) in the absence of a magnetic field.

### Table of Contents

<b>1 Functional Diagram .....</b>	<b>1</b>
<b>2 General Description.....</b>	<b>1</b>
<b>3 Glossary of Terms .....</b>	<b>3</b>
<b>4 Absolute Maximum Ratings.....</b>	<b>3</b>
<b>5 Pin Definitions and Descriptions.....</b>	<b>3</b>
<b>6 General Electrical Specifications .....</b>	<b>4</b>
<b>7 Magnetic Specifications .....</b>	<b>4</b>
<b>8 Outputs Behaviour vs. Magnetic Pole.....</b>	<b>4</b>
<b>9 Detailed General Description.....</b>	<b>5</b>
<b>10 Unique Features.....</b>	<b>5</b>
<b>11 Performance Graphs .....</b>	<b>6</b>
11.1 Magnetic Thresholds vs. $T_A$ .....	6
11.2 Magnetic Thresholds vs. $V_{DD}$ .....	6
11.3 Current Consumption vs. $T_A$ .....	6
11.4 Current Consumption vs. $V_{DD}$ .....	6
11.5 Consumption Period vs. $T_A$ .....	6
11.6 Consumption Period vs. $V_{DD}$ .....	6
11.7 Output Saturation Voltage vs. $T_A$ .....	7
11.8 Output Switching Characteristics .....	7
<b>12 Application Information.....</b>	<b>7</b>
<b>13 Standard information regarding manufacturability of Melexis products with different soldering processes.....</b>	<b>8</b>
<b>14 ESD Precautions.....</b>	<b>8</b>
<b>15 Package Information.....</b>	<b>9</b>
15.1 SE Package (TSOT-3L).....	9
15.2 LD Package (UTQFN-6L) .....	10
<b>16 Disclaimer.....</b>	<b>11</b>



### 3 Glossary of Terms

Gauss, milliTesla (mT), Units of magnetic flux density :  
10 Gauss = 1mT

### 4 Absolute Maximum Ratings

Parameter	Symbol	Value	Units
Supply Voltage	V <sub>DD</sub>	5	V
Supply Current	I <sub>DD</sub>	5	mA
Output Voltage	V <sub>OUT</sub>	5	V
Output Current	I <sub>OUT</sub>	10	mA
Operating Temperature Range	T <sub>A</sub>	-40 to 85	°C
Storage Temperature Range	T <sub>S</sub>	-50 to 150	°C
ESD Sensitivity - HBM <sup>(1)</sup>	-	8000	V
ESD Sensitivity - MM <sup>(2)</sup>	-	800	V

Table 1: Absolute maximum ratings

**Note 1:** Human Body Model according JESD22-A114 standard – 100pF capacitor discharged through 1.5kΩ resistor into each pin.

**Note 2:** Machine Model according JESD22-A115 standard – 200pF capacitor discharged directly (0Ω resistor) into each pin.

Exceeding the absolute maximum ratings may cause permanent damage. Exposure to absolute-maximum-rated conditions for extended periods may affect device reliability.

### 5 Pin Definitions and Descriptions

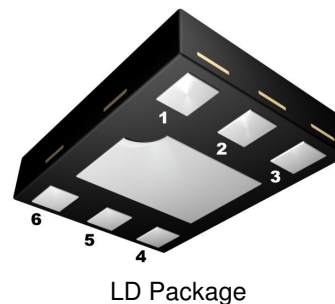
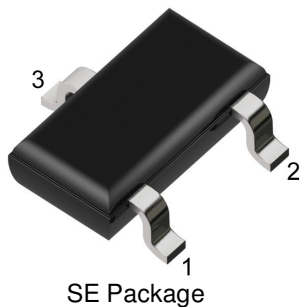

Pin Name	Function	Pin № (SE)	Pin № (LD)
VDD	Power Supply	1	2
GND	Ground	3	4
OUT	Output (Open Drain)	2	5
NC	Not Connected	-	1,3,6

Table 2: Pin definitions and descriptions

**Note :** Exposed Pad on LD package is connected to ground

### 6 General Electrical Specifications

DC Operating Parameters  $T_A = 25^\circ\text{C}$ ,  $V_{DD} = 1.5\text{V to } 3.6\text{V}$  (unless otherwise specified)

Parameter	Symbol	Test Conditions	Min	Typ	Max	Units
Supply Voltage	$V_{DD}$	Operating	1.5	-	3.6	V
Awake Supply Current	$I_{DD\text{awake}}$	$V_{DD} = 3.6\text{V}$	-	3	5	mA
Sleep Supply Current	$I_{DD\text{sleep}}$	$V_{DD} = 3.6\text{V}$	-	3.5	6	$\infty\text{A}$
Average Supply Current	$I_{DD\text{av}}$	$V_{DD} = 3.6\text{V}$ , Average	-	6.5	10	$\infty\text{A}$
Output Saturation Voltage	$V_{SAT}$	$I_{OUT} = 1\text{mA}$	-	0.27	0.4	V
Output Leakage Current	$I_{LEAK}$	$V_{DD} = 3.6\text{V}$	-	-	1	$\infty\text{A}$
Awake Period	$T_{AW}$	Operating	30	50	120	$\infty\text{s}$
Sleep Period	$T_{SL}$	Operating	25	40	70	ms

Table 3: Electrical specifications

### 7 Magnetic Specifications

DC Operating Parameters  $T_A = 25^\circ\text{C}$ ,  $V_{DD} = 1.5\text{V to } 3.6\text{V}$  (unless otherwise specified)

Parameter	Symbol	Min	Typ	Max	Units
Operating Point	$B_{OP}$	+/-1.1	-	+/-6	mT
Release Point	$B_{RP}$	+/-0.8	-	+/-5.7	mT
Hysteresis	$B_{HYST}$	0.3	-	2.3	mT

Table 4: Magnetic specifications

**Note :** For typical values, please refer to the performance graphs section

### 8 Outputs Behaviour vs. Magnetic Pole

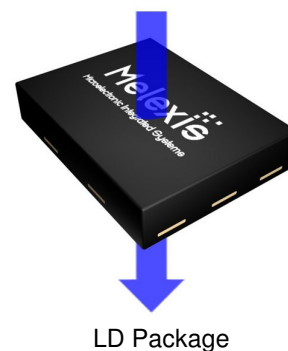

Parameter	Test conditions	OUT (SE)	OUT (LD)
North or South pole	$B >  B_{OP} $	Low	Low
"Zero" magnetic pole	$B <  B_{RP} $	High	High

Table 5: Outputs behaviour vs. magnetic pole

**Note :** The magnetic pole is applied facing the branded side of the package

## 9 Detailed General Description

The MLX90248 is originally used in mobile phone applications for open/close lid detection (flip, slide and swivel phone type). The goal of this detection is to switch on or off the application if the lid is opened or closed, in order to save battery power.

The same operation principle can be simply applied to any other battery-powered device with a lid/cover like laptop, digital cameras and camcorders.

By the use of a very high sensitivity Hall sensor, a very small and cheap magnet is enough to trigger the MLX90248, hence it can easily replace reed switch.

The major benefit of using a Hall sensor is to provide “electronic” commutation, which is bounce-free, more reliable and with increased lifetime compared to usual mechanical contacts.

## 10 Unique Features

The MLX90248 exhibits “Omnipolar” magnetic characteristics. It means the device reacts to both North and South magnetic pole. The purpose is to detect the presence of any magnetic field applied on the device.

This mode of operation simplifies customer production processes by avoiding the need to detect the Hall sensor pole active on the magnet used in the application.

Taking the example of a generic Hall sensor “south pole active”, during its production, the customer must detect the south pole of the application magnet and face it to the device to enable the output to be turned on and off. Without any magnet pole detection system, the incorrect magnetic pole (north in this example) could be faced to the device which would fail the application.

Therefore, the “Omnipolar” magnetic behaviour helps customers by removing the need of magnet pole detection system during production phase.

The “Micropower” feature makes the MLX90248 especially suitable for battery-powered device as it combines low voltage operation and low current consumption. By using a sleep/awake strategy managed internally, the power consumption is drastically reduced. To make a comparison, the MLX90248 consumes 100 times less power than the generic low voltage Melexis Hall sensor US3881.

As well as Thin SOT package, the MLX90248 is now delivered in an ultra thin UTQFN package. This new leadless package only requires 3mm<sup>2</sup> PCB surface and is 0.43mm maximum thick, which is particularly important in design where space-saving and miniaturisation are the critical factors.

### 11 Performance Graphs

Unless otherwise specified, performance graphs given at  $V_{DD} = 3.6V$  and  $T_A = 25$  degree C.

#### 11.1 Magnetic Thresholds vs. $T_A$

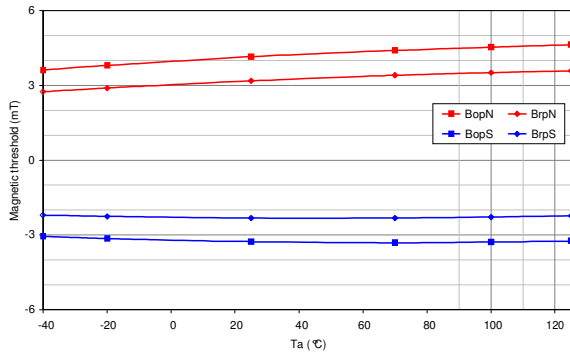

#### 11.2 Magnetic Thresholds vs. $V_{DD}$

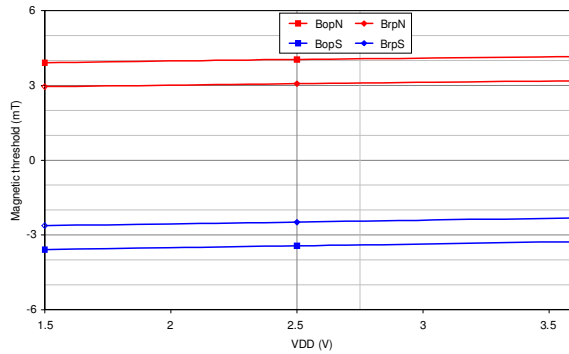

#### 11.3 Current Consumption vs. $T_A$

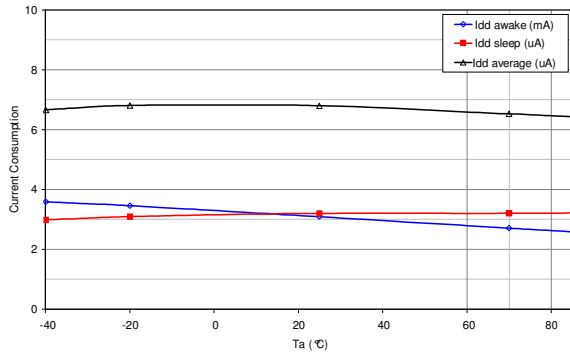

#### 11.4 Current Consumption vs. $V_{DD}$

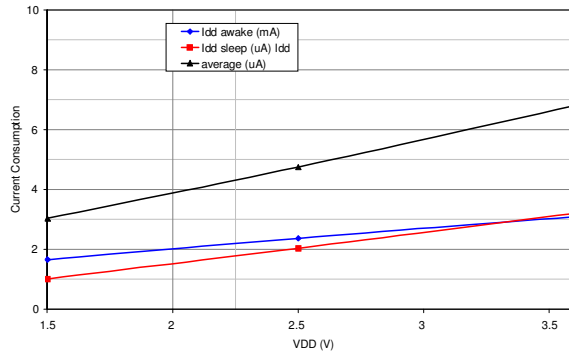

#### 11.5 Consumption Period vs. $T_A$

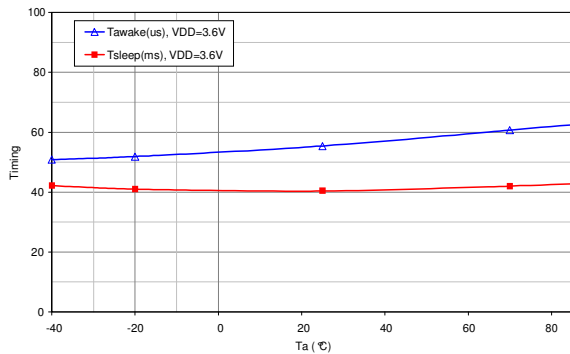

#### 11.6 Consumption Period vs. $V_{DD}$

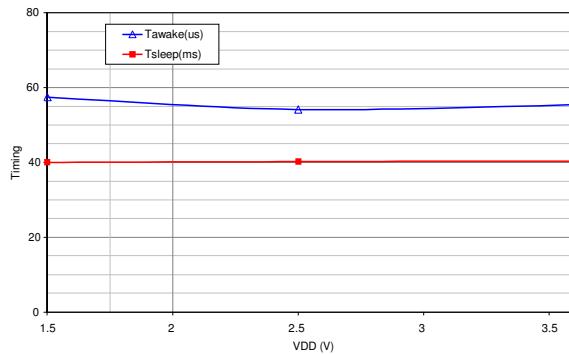

## 11.7 Output Saturation Voltage vs. $T_A$

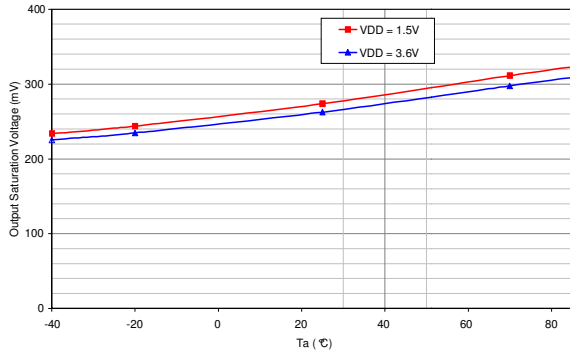

## 11.8 Output Switching Characteristics

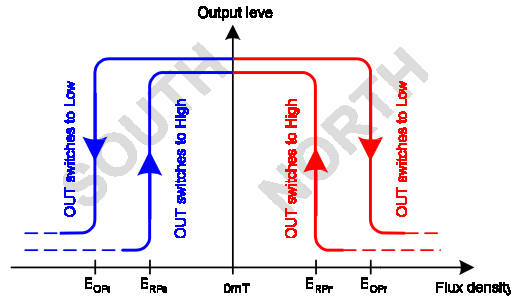

## 12 Application Information

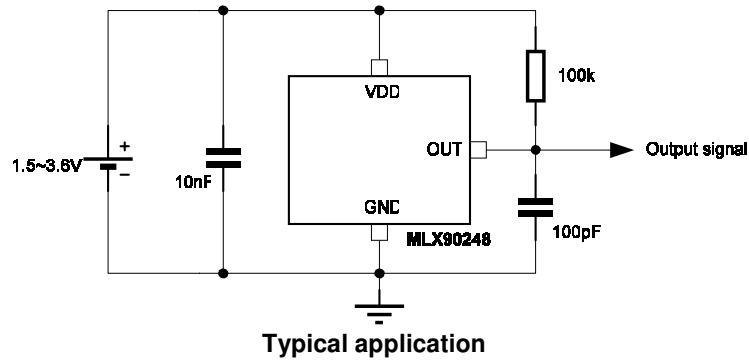



## 13 Standard information regarding manufacturability of Melexis products with different soldering processes

Our products are classified and qualified regarding soldering technology, solderability and moisture sensitivity level according to following test methods:

### Reflow Soldering SMD's (Surface Mount Devices)

IPC/JEDEC J-STD-020  
Moisture/Reflow Sensitivity Classification for Nonhermetic Solid State Surface Mount Devices  
(classification reflow profiles according to table 5-2)  
EIA/JEDEC JESD22-A113  
Preconditioning of Nonhermetic Surface Mount Devices Prior to Reliability Testing  
(reflow profiles according to table 2)

### Wave Soldering SMD's (Surface Mount Devices) and THD's (Through Hole Devices)

EN60749-20  
Resistance of plastic- encapsulated SMD's to combined effect of moisture and soldering heat  
EIA/JEDEC JESD22-B106 and EN60749-15  
Resistance to soldering temperature for through-hole mounted devices

### Iron Soldering THD's (Through Hole Devices)

EN60749-15  
Resistance to soldering temperature for through-hole mounted devices

### Solderability SMD's (Surface Mount Devices) and THD's (Through Hole Devices)

EIA/JEDEC JESD22-B102 and EN60749-21  
Solderability

For all soldering technologies deviating from above mentioned standard conditions (regarding peak temperature, temperature gradient, temperature profile etc) additional classification and qualification tests have to be agreed upon with Melexis.

The application of Wave Soldering for SMD's is allowed only after consulting Melexis regarding assurance of adhesive strength between device and board.

Melexis is contributing to global environmental conservation by promoting **lead free** solutions. For more information on qualifications of **RoHS** compliant products (RoHS = European directive on the Restriction Of the use of certain Hazardous Substances) please visit the quality page on our website:

<http://www.melexis.com/quality.aspx>

## 14 ESD Precautions

Electronic semiconductor products are sensitive to Electro Static Discharge (ESD).  
Always observe Electro Static Discharge control procedures whenever handling semiconductor products.

### 15 Package Information

#### 15.1 SE Package (TSOT-3L)

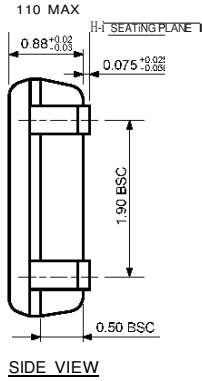
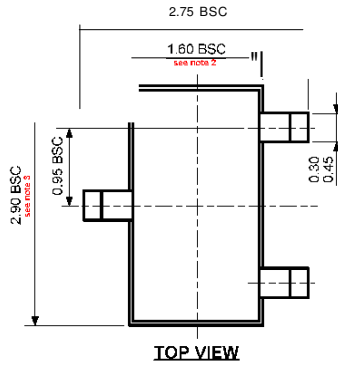

**Notes:**

1. All dimensions are in millimeters
2. Outermost plastic extreme width does not include mold flash or protrusions. Mold flash and protrusions shall not exceed 0.15mm per side
3. Outermost plastic extreme length does not include mold flash or protrusions. Mold flash and protrusions shall not exceed 0.25mm per side
4. The lead width dimension does not include dambar protrusion. Allowable dambar protrusion shall be 0.07mm total in excess of the lead width dimension at maximum material condition
5. Dimension IS the length of terminal for soldering
6. Dimension on SECTION B-B' are apply to the flat section of the lead between 0.00mm and a.15mm from the lead tip.
7. Formed lead shall be planar with respect to one another with 0.076mm at seating plane

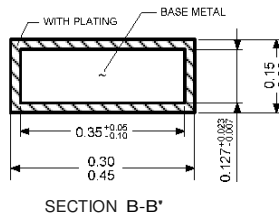
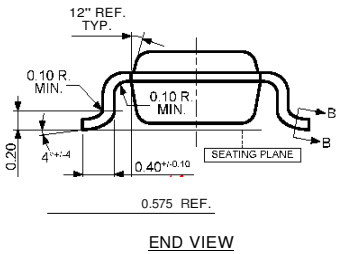

**Marking:**

Top side 248E- Name of the Device (MLX90248)  
 Bottom side xyww x = last digit of lot number  
 y last digit of year  
 WN \*\*week

#### Hall plate location

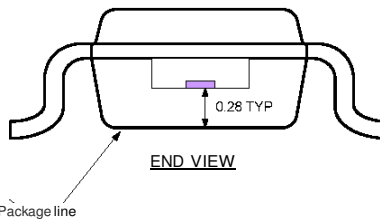
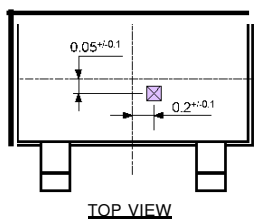

**Notes:**

1. All dimensions are in millimeters

### 15.2 LD Package (UTQFN-6L)

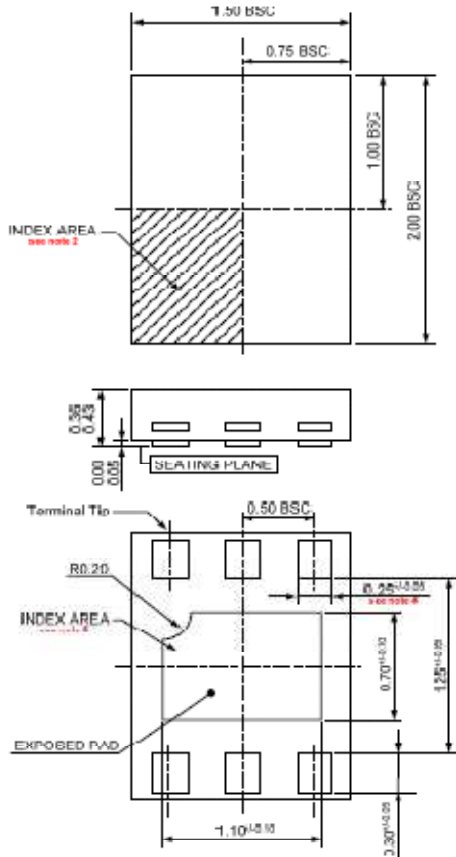

**Notes:**

1. All dimensions are in millimeters.
2. The terminal #1 identifier and terminal numbering convention shall conform JEDEC publication 95 SPP-002. Details of terminal #1 identifier are optional, but must be located within the zone indicated. The terminal #1 identifier may be marked feature.
3. Depopulation is possible in a symmetrical fashion.
4. Pad length applies to metallized terminal and is measured between 0.15mm and 0.30mm from the terminal tip. If the terminal has the optional radius on the other end of the terminal, the pad length should not be measured in that radius area.

**Marking:**

- 1<sup>st</sup> Line : 4E  
 . (dot) - used to show the 1<sup>st</sup> pin  
 4E - Name of the device (MLX90248)
- 2<sup>nd</sup> Line : YWW  
 Y - Year (last digit)  
 WW - Calendar Week

**Hall plate location**

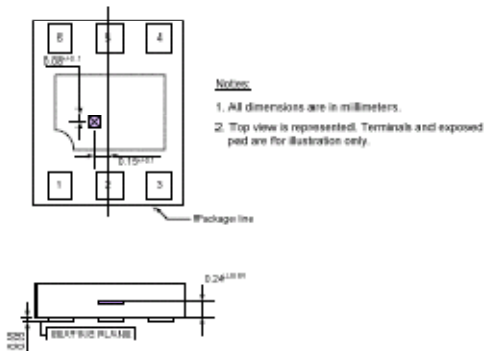

**Land Pattern**

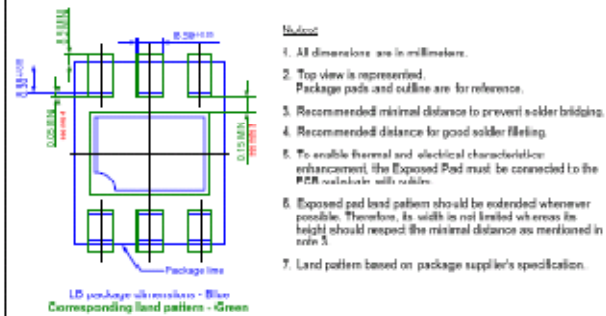

## 16 Disclaimer

Devices sold by Melexis are covered by the warranty and patent indemnification provisions appearing in its Term of Sale. Melexis makes no warranty, express, statutory, implied, or by description regarding the information set forth herein or regarding the freedom of the described devices from patent infringement. Melexis reserves the right to change specifications and prices at any time and without notice. Therefore, prior to designing this product into a system, it is necessary to check with Melexis for current information. This product is intended for use in normal commercial applications. Applications requiring extended temperature range, unusual environmental requirements, or high reliability applications, such as military, medical life-support or life-sustaining equipment are specifically not recommended without additional processing by Melexis for each application.

The information furnished by Melexis is believed to be correct and accurate. However, Melexis shall not be liable to recipient or any third party for any damages, including but not limited to personal injury, property damage, loss of profits, loss of use, interrupt of business or indirect, special incidental or consequential damages, of any kind, in connection with or arising out of the furnishing, performance or use of the technical data herein. No obligation or liability to recipient or any third party shall arise or flow out of Melexis' rendering of technical or other services.

© 2012 Melexis NV. All rights reserved.

For the latest version of this document, go to our website at  
**[www.melexis.com](http://www.melexis.com)**

Or for additional information contact Melexis Direct:

<b>Europe, Africa, Asia:</b>	<b>America:</b>
Phone: +32 1367 0495	Phone: +1 248 306 5400
E-mail: <a href="mailto:sales_europe@melexis.com">sales_europe@melexis.com</a>	E-mail: <a href="mailto:sales_usa@melexis.com">sales_usa@melexis.com</a>

ISO/TS 16949 and ISO14001 Certified