



Chipsmall Limited consists of a professional team with an average of over 10 year of expertise in the distribution of electronic components. Based in Hongkong, we have already established firm and mutual-benefit business relationships with customers from,Europe,America and south Asia,supplying obsolete and hard-to-find components to meet their specific needs.

With the principle of “Quality Parts,Customers Priority,Honest Operation,and Considerate Service”,our business mainly focus on the distribution of electronic components. Line cards we deal with include Microchip,ALPS,ROHM,Xilinx,Pulse,ON,Everlight and Freescale. Main products comprise IC,Modules,Potentiometer,IC Socket,Relay,Connector.Our parts cover such applications as commercial,industrial, and automotives areas.

We are looking forward to setting up business relationship with you and hope to provide you with the best service and solution. Let us make a better world for our industry!



Contact us

Tel: +86-755-8981 8866 Fax: +86-755-8427 6832

Email & Skype: info@chipsmall.com Web: www.chipsmall.com

Address: A1208, Overseas Decoration Building, #122 Zhenhua RD., Futian, Shenzhen, China



Features and Benefits

Triaxis® Hall Technology
 On Chip Signal Processing for Robust Absolute Position Sensing
 Simple Magnetic Design
 Programmable Measurement Range
 Programmable Linear Transfer Characteristic (Multi-points or Piece-Wise-Linear)
 Selectable Analog (Ratiometric) or PWM Output
 12 bit Resolution - 10 bit Thermal Accuracy
 48 bit ID Number option
 Single Die – SOIC-8 Package RoHS Compliant
 Dual Die (Full Redundant) – TSSOP-16 Package RoHS Compliant

Applications

Absolute Rotary Position Sensor	Absolute Linear Position Sensor
Pedal Position Sensor	Steering Wheel Position Sensor
Throttle Position Sensor	Float-Level Sensor
Ride Height Position Sensor	Non-Contacting Potentiometer

Ordering Code

Product Code	Temperature Code	Package Code	Option Code	Packing Form Code
MLX90360	L	GO	ACD-000	RE
MLX90360	L	GO	ACD-000	TU
MLX90360	L	DC	ACD-000	RE
MLX90360	L	DC	ACD-000	TU
MLX90360	K	GO	ACD-000	RE
MLX90360	K	GO	ACD-000	TU
MLX90360	E	GO	ACD-000	RE
MLX90360	E	GO	ACD-000	TU
MLX90360	K	DC	ACD-000	RE
MLX90360	K	DC	ACD-000	TU
MLX90360	E	DC	ACD-000	RE
MLX90360	E	DC	ACD-000	TU
MLX90360	L	DC	ACD-200	RE
MLX90360	L	DC	ACD-200	TU

Legend:

Temperature Code: L for Temperature Range -40°C to 150°C,
 K for Temperature Range -40°C to 125°C,
 E for Temperature Range -40°C to 85°C.

Package Code: DC for SOIC-8, GO for TSSOP-16

Option Code: AAA-xxx: Die version
 xxx-000: Standard version
 xxx-200: (pre-programmed analog)

Packing Form: RE for Reel, TU for Tube

Ordering example: MLX90360LGO-ACD-000-TU

1. Functional Diagram

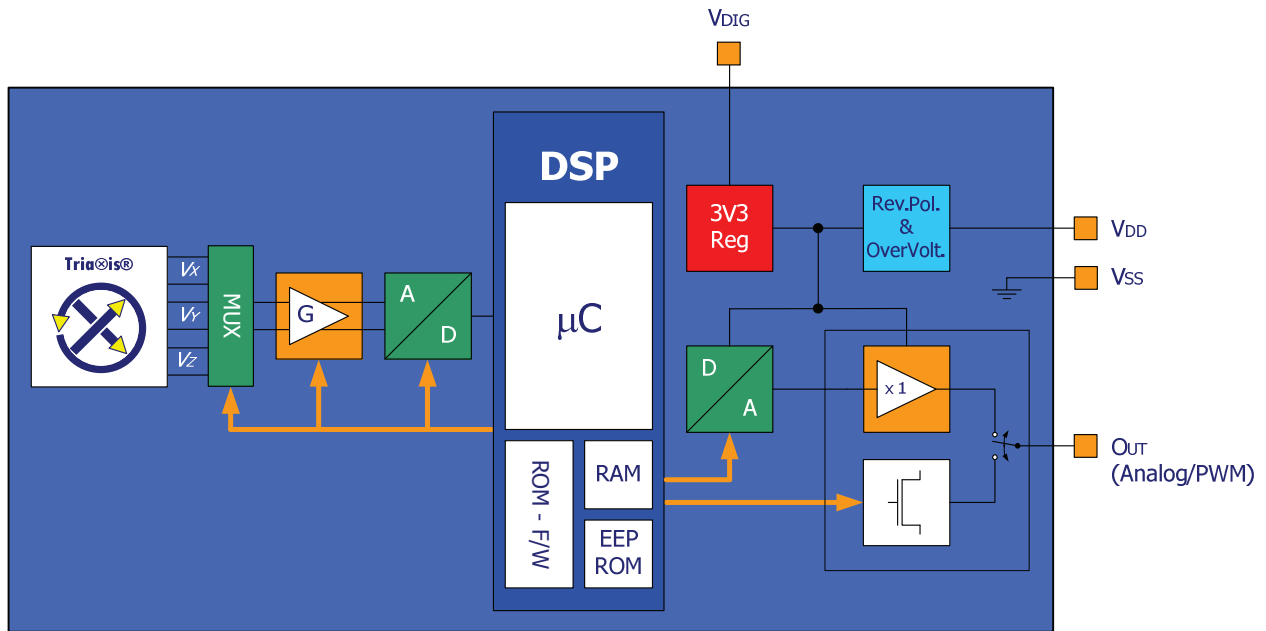

Figure 1 - MLX 90360 Block Diagram

2. Description

The MLX90360 is a monolithic sensor IC sensitive to the flux density applied orthogonally and parallel to the IC surface.

The MLX90360 is sensitive to the three components of the flux density applied to the IC (i.e. B_x , B_y and B_z). This allows the MLX90360 with the correct magnetic circuit to decode the absolute position of any moving magnet (e.g. rotary position from 0 to 360 Degrees or linear displacement, stroke - Figure 2). It enables the design of novel generation of non-contacting position sensors that are frequently required for both automotive and industrial applications.

MLX90360 reports a programmable ratiometric analog output signal compatible with any resistive potentiometer or programmable linear Hall sensor. Through programming, the MLX90360 provides also a digital PWM (Pulse Width Modulation) output characteristic.

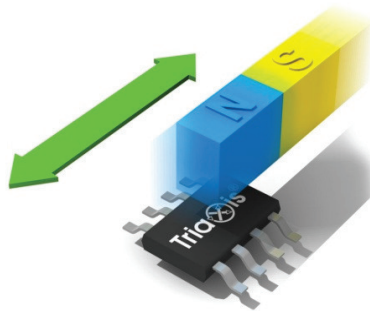

Figure 2 - Typical application of MLX90360 – Linear

TABLE of CONTENTS

FEATURES AND BENEFITS	1
APPLICATIONS.....	1
1. FUNCTIONAL DIAGRAM.....	2
2. DESCRIPTION.....	3
3. GLOSSARY OF TERMS – ABBREVIATIONS – ACRONYMS	6
4. PINOUT	6
5. ABSOLUTE MAXIMUM RATINGS	7
6. DESCRIPTION.....	7
7. MLX90360 ELECTRICAL SPECIFICATION.....	9
8. MLX90360 ISOLATION SPECIFICATION	11
9. MLX90360 TIMING SPECIFICATION	11
10. MLX90360 ACCURACY SPECIFICATION	12
11. MLX90360 MAGNETIC SPECIFICATION	13
12. MLX90360 CPU & MEMORY SPECIFICATION	13
13. MLX90360 END-USER PROGRAMMABLE ITEMS.....	14
14. DESCRIPTION OF END-USER PROGRAMMABLE ITEMS.....	15
14.1. OUTPUT MODE.....	15
14.1.1. Analog Output Mode.....	15
14.1.2. PWM Output Mode.....	15
14.2. OUTPUT TRANSFER CHARACTERISTIC.....	16
14.2.1. Enable scaling Parameter (only for LNR type 4 pts)	16
14.2.2. CLOCKWISE Parameter.....	16
14.2.3. Discontinuity Point (or Zero Degree Point).....	17
14.2.4. 4-Pts LNR Parameters.....	17
14.2.5. 17-Pts LNR Parameters.....	18
14.2.6. CLAMPING Parameters	19
14.3. IDENTIFICATION	19
14.4. SENSOR FRONT-END	19
14.4.1. HIGHSPEED Parameter.....	19
14.4.2. MAPXYZ.....	20
14.4.3. k parameter	20
14.4.4. GAINMIN and GAINMAX Parameters	20
14.5. FILTER	20
14.5.1. Hysteresis Filter	21
14.5.2. FIR Filters	21
14.6. PROGRAMMABLE DIAGNOSTIC SETTINGS	22
14.6.1. Fixed-level diagnostic reporting	22
14.6.2. PWM Diagnostic reporting	23
14.6.3. HAMHOLE Parameter.....	24
14.7. LOCK.....	24
14.8. EEPROM ENDURANCE	25
15. MLX90360 SELF DIAGNOSTIC.....	26
16. RECOMMENDED APPLICATION DIAGRAMS.....	28
16.1. WIRING WITH THE MLX90360 IN SOIC-8 PACKAGE	28

16.2.	WIRING WITH THE MLX90360 IN TSSOP-16 PACKAGE	28
17.	STANDARD INFORMATION REGARDING MANUFACTURABILITY OF MELEXIS PRODUCTS WITH DIFFERENT SOLDERING PROCESSES	29
18.	ESD PRECAUTIONS.....	29
19.	PACKAGE INFORMATION.....	30
19.1.	SOIC8 - PACKAGE DIMENSIONS	30
19.2.	SOIC8 - PINOUT AND MARKING	30
19.3.	SOIC8 - SENSITIVE SPOT POSITIONING	31
19.4.	TSSOP16 - PACKAGE DIMENSIONS	32
19.5.	TSSOP16 - PINOUT AND MARKING	33
19.6.	TSSOP16 - SENSITIVE SPOT POSITIONING	33
20.	DISCLAIMER.....	35

3. Glossary of Terms – Abbreviations – Acronyms

- Gauss (G), Tesla (T): Units for the magnetic flux density – 1 mT = 10 G
- TC: Temperature Coefficient (in ppm/Deg.C.)
- NC: Not Connected
- PWM: Pulse Width Modulation
- %DC: Duty Cycle of the output signal i.e. $T_{ON} / (T_{ON} + T_{OFF})$
- ADC: Analog-to-Digital Converter
- DAC: Digital-to-Analog Converter
- LSB: Least Significant Bit
- MSB: Most Significant Bit
- DNL: Differential Non-Linearity
- INL: Integral Non-Linearity
- RISC: Reduced Instruction Set Computer
- ASP: Analog Signal Processing
- DSP: Digital Signal Processing
- CoRDIC: Coordinate Rotation Digital Computer (i.e. iterative rectangular-to-polar transform)
- EMC: Electro-Magnetic Compatibility
- ALS: Analog Low Speed
- AHS: Analog High Speed
- DLS: Digital Low Speed
- DHS: Digital High Speed

4. Pinout

Pin #	SOIC-8	TSSOP-16
1	VDD	VDIG ₁
2	Test 0	VSS ₁ (Ground ₁)
3	Test 2	VDD ₁
4	Not Used	Test 0 ₁
5	OUT	Test 2 ₂
6	Test 1	OUT ₂
7	VDIG	Not Used ₂
8	VSS (Ground)	Test 1 ₂
9		VDIG ₂
10		VSS ₂ (Ground ₂)
11		VDD ₂
12		Test 0 ₂
13		Test 2 ₁
14		Not Used ₁
15		OUT ₁
16		Test 1 ₁

For optimal EMC behavior, it is recommended to connect the unused pins (Not Used and Test) to the Ground (see section 16).

5. Absolute Maximum Ratings

Parameter	Value
Supply Voltage, VDD (overvoltage)	+ 24 V
Reverse Voltage Protection	– 12 V (breakdown at -14 V)
Positive Output Voltage	+ 18 V (breakdown at 24 V)
Output Current (I _{OUT})	+ 30 mA (in breakdown)
Reverse Output Voltage	– 0.3 V
Reverse Output Current	– 50 mA (in breakdown)
Operating Ambient Temperature Range, T _A	– 40°C ... + 150°C
Storage Temperature Range, T _S	– 40°C ... + 150°C
Magnetic Flux Density	± 1 T

Exceeding the absolute maximum ratings may cause permanent damage. Exposure to absolute maximum rated conditions for extended periods may affect device reliability.

6. Description

As described on the block diagram the three vector components of the magnetic flux density (B_X, B_Y and B_Z) applied to the IC are sensed through the sensor front-end. The respective Hall signals (V_X, V_Y and V_Z) are generated at the Hall plates and amplified.

The analog signal processing is based on a fully differential analog chain featuring the classic offset cancellation technique (Hall plate 2-Phases spinning and chopper-stabilized amplifier).

The conditioned analog signals are converted through an ADC (15 bits) and provided to a DSP block for further processing. The DSP stage is based on a 16 bit RISC micro-controller whose primary function is the extraction of the position from two (out of three) raw signals (after so-called front-end compensation steps) through the following function:

$$\alpha = \angle(V_1, k \cdot V_2)$$

where alpha is the magnetic angle <(B1, B2), V₁ = V_X or V_Y or V_Z, V₂ = V_X or V_Y or V_Z and k is a programmable factor to match the amplitude of V₁ and k V₂.

The DSP functionality is governed by the micro-code (firmware – F/W) of the micro-controller which is stored into the ROM (mask programmable). In addition to the magnetic angle extraction, the F/W controls the whole analog chain, the output transfer characteristic, the output protocol, the programming/calibration and also the self-diagnostic modes.

The magnetic angular information is intrinsically self-compensated vs. flux density variations. This feature allows therefore an improved thermal accuracy vs position sensor based on conventional linear Hall sensors.

In addition to the improved thermal accuracy, the realized position sensor features excellent linearity performances taking into account typical manufacturing tolerances (e.g. relative placement between the Hall IC and the magnet).

Once the position (angular or linear stroke) information is computed, it is further conditioned (mapped) vs. the target transfer characteristic and it is provided at the output(s) as either a ratiometric analog output level through a 12 bit DAC followed by a buffer or a digital PWM output.

For instance, the analog output can be programmed for offset, gain and clamping to meet any rotary position sensor output transfer characteristic:

$$\begin{aligned} V_{out}(\alpha) &= \text{ClampLo} && \text{for } \alpha \leq \alpha_{min} \\ V_{out}(\alpha) &= V_{offset} + \text{Gain} \times \alpha && \text{for } \alpha_{min} \leq \alpha \leq \alpha_{max} \\ V_{out}(\alpha) &= \text{ClampHi} && \text{for } \alpha \geq \alpha_{max} \end{aligned}$$

where V_{offset} , Gain , ClampLo and ClampHi are the main adjustable parameters for the end-user.

The linear part of the transfer curve can be adjusted through a multi-point calibration:

This back-end step consists into either

- up to 4 arbitrary points (5 segments + clamping levels) calibration or
- a Piece-Wise-Linear (PWL) output transfer characteristics - 17 equidistant points w/ programmable origin over 16 different angle ranges from 65 to 360 degrees.

The calibration parameters are stored in EEPROM featuring a Hamming Error Correction Coding (ECC).

The programming steps do not require any dedicated pins. The operation is done using the supply and output nodes of the IC. The programming of the MLX90360 is handled at both engineering lab and production line levels by the Melexis Programming Unit PTC-04 with the dedicated MLX90360 daughterboard and software tools (DLL – User Interface).

7. MLX90360 Electrical Specification

DC Operating Parameters at VDD = 5V (unless otherwise specified) and for TA as specified by the Temperature suffix (E or K or L).

Parameter	Symbol	Test Conditions	Min	Typ	Max	Units
Nominal Supply Voltage	VDD		4.5	5	5.5	V
Supply Current ⁽¹⁾	I _{dd}	Slow mode ⁽²⁾ Fast mode ⁽²⁾		8.5 13.5	12 15	mA mA
POR Rising Level	POR LH	Supply Under Voltage In reference to On-chip digital voltage VDIG	2.4	2.7	3	V
POR Falling Level	POR HL	Supply Under Voltage In reference to On-chip digital voltage VDIG	2	2.3	2.6	V
POR Hysteresis	POR Hyst	Hysteresis on POR signal In reference to On-chip digital voltage VDIG	0.3	0.4	0.6	V
ASP Start Rising Level	LT4V LH	Startup Level of ASP	3.5		4.1	V
ASP Start Falling Level	LT4V HL	Startup Level of ASP	3.4		4	V
ASP Start Hysteresis	LT4V Hyst	Startup Level of ASP	0.1		0.5	V
PTC Entry Rising Level	MT7V LH	VDD level for PTC entry	6.6		7.2	V
PTC Entry Falling Level	MT7V HL	VDD level for PTC entry	6.5		7.1	V
PTC Entry Hysteresis	MT7V Hyst	VDD level for PTC entry	0.1		0.4	V
Switch Off Rising Level	LT11V LH		8.6		14	V
Switch Off Falling Level	LT11V HL		8.5		13.9	V
Switch Off Level Hysteresis	LT11 Hyst		0.1		1	V
Output Current	I _{out}	Analog Output mode	-15		15	mA
Output Short Circuit Current	I _{short}	V _{out} = 0 V V _{out} = 5 V V _{out} = 14 V (T _A = 25°C)			15 15 18	mA mA mA
Output Load	R _L	Pull-down to Ground Pull-up to 5V	1 1	10 10	∞ ∞	kΩ kΩ
Analog Saturation Output Level	V _{sat_lo}	Pull-up load R _L ≥ 10 kΩ to 5 V Pull-up load R _L ≥ 1 kΩ to 5V Pull-up load R _L ≥ 5 kΩ to 14V		0.5 2 2	2 3 3	%VDD
	V _{sat_hi}	Pull-down load R _L ≥ 5 kΩ Pull-down load R _L ≥ 10 kΩ	94 96	96 98		%VDD
Active Diagnostic Output Level	Diag_lo	Pull-up load R _L ≥ 1 kΩ to 5V Pull-up load R _L = 1 kΩ to 5V Pull-up load R _L ≥ 5 kΩ to 14V	1	2 1.5 2	3 2 3	%VDD
	Diag_hi	Pull-down load R _L ≥ 10kΩ Pull-down load R _L ≥ 5kΩ	96 94	98 96		%VDD

¹ For the dual version, the supply current is multiplied by 2

² See section 9 for details concerning Slow and Fast mode

		Pull-down load $R_L = 5k\Omega$	97	97.5		
Passive Diagnostic Output Level (Broken Track Diagnostic) ⁽³⁾	BVSSPD	Broken VSS & Pull-down load $R_L \leq 10 k\Omega$ (Hi-Z)	0		4 ⁽³⁾	%VDD
		Pull-down load $R_L \leq 25 k\Omega$ (Hi-Z)	0		10	
	BVSSPU	Broken VSS & Pull-up load $R_L \geq 1k\Omega$	99	100		%VDD
	BVDDPD	Broken VDD & Pull-down load $R_L \geq 1k\Omega$		0	1	%VDD
Clamped Output Level	BVDDPU	Broken VDD & Pull-up load $R_L \leq 10k\Omega$ (Hi-Z)	96		100	%VDD
	Clamp_lo	Programmable	0		100	%VDD ⁽⁴⁾
	Clamp_hi	Programmable	0		100	%VDD ⁽⁴⁾

As an illustration of the previous table, the MLX90360 fits the typical classification of the output span described on the Figure 6.

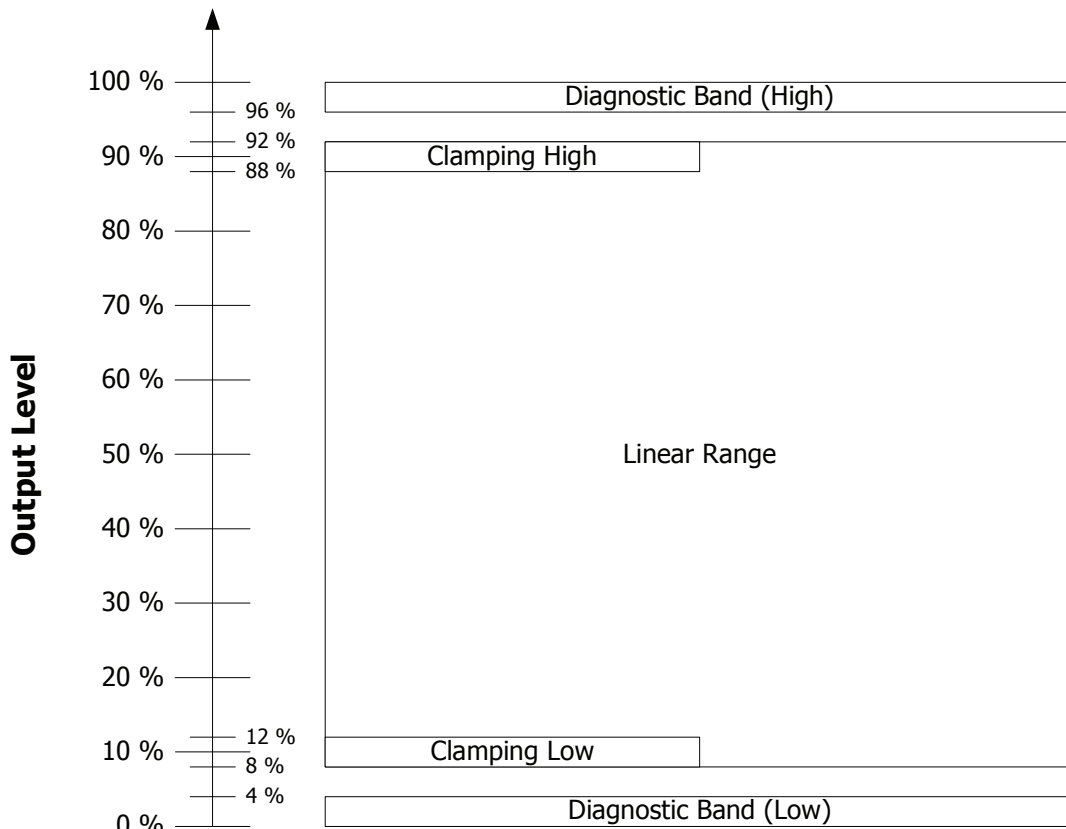

Figure 6 – Example of Output Span Classification for typical application.

³ For detailed information, see also section 15

⁴ Clamping levels need to be considered vs the saturation of the output stage (see V_{sat_lo} and V_{sat_hi})

8. MLX90360 Isolation Specification

DC Operating Parameters at VDD = 5V (unless otherwise specified) and for T_A as specified by the Temperature suffix (E or K or L). Only valid for the package code GO i.e. dual die version.

Parameter	Symbol	Test Conditions	Min	Typ	Max	Units
Isolation Resistance		Between 2 dies	4			MΩ

9. MLX90360 Timing Specification

DC Operating Parameters at VDD = 5V (unless otherwise specified) and for T_A as specified by the Temperature suffix (E or K or L).

Parameter	Symbol	Test Conditions	Min	Typ	Max	Units
Main Clock Frequency	Ck	Slow mode ⁽⁵⁾	6.4	6.5	6.6	MHz
		Fast mode ⁽⁵⁾	9.9	10.0	10.1	MHz
Main Clock Frequency Thermal Drift	Δ ^T Ck	Lifetime included			± 10%	Ck _{NOM}
Output Refresh Rate		Slow mode		660		μs
		Fast mode		400		μs
Step Response Time	Ts	SlewRate effect excluded				
		Slow mode ⁽⁵⁾ , Filter=0 ⁽⁶⁾		1.32	2.18	ms
		Slow mode ⁽⁵⁾ , Filter=2 ⁽⁶⁾		2.64	3.63	ms
		Fast mode ⁽⁵⁾ , Filter=0 ⁽⁶⁾		0.80	1.32	ms
Watchdog	Wd	Slow Mode (Ck = 6 MHz) See Section 15		4.58		ms
Phase Shift	PS	Slow mode ⁽⁵⁾ , Filter=0 ⁽⁶⁾		0.422		Deg/Hz
Start-up Cycle	Tsu	SlewRate effect excluded				
		Slow mode		12.5	15	ms
		Fast mode		7.5	10	ms
Analog Output Slew Rate		Mode 1 from C _{OUT} = 47 nF to 330 nF		37		V/ms
		Mode 2 up to C _{OUT} = 10 nF		320		V/ms
		Mode 3 up to C _{OUT} = 47 nF		19		V/ms
		Mode 4 up to C _{OUT} = 330 nF		2.5		V/ms

⁵ See section 13 for details concerning Slow and Fast mode activation

⁶ See section 14.5 for details concerning Filter parameter

10. MLX90360 Accuracy Specification

DC Operating Parameters at $V_{DD} = 5V$ (unless otherwise specified) and for T_A as specified by the Temperature suffix (E or K or L).

Parameter	Symbol	Test Conditions	Min	Typ	Max	Units
ADC Resolution on the raw signals sine and cosine ⁽⁷⁾	R_{ADC}			15		bits
Thermal Offset Drift #1 ⁽⁸⁾ at the DSP input (excl. DAC and output stage)		Temperature suffix E	-60		+60	LSB ₁₅
		Temperature suffix K	-60		+60	LSB ₁₅
		Temperature suffix L	-90		+90	LSB ₁₅
Thermal Offset Drift #2 (DAC and Output Stage)			-0.25		+0.25	%VDD
Thermal Drift of Sensitivity Mismatch ⁽⁹⁾		XY axis – Temp. suffix E	- 0.3		+ 0.3	%
		XY axis – Temp. suffix K & L	- 0.5		+ 0.5	%
		XZ (YZ) axis – Temp. suffix E	-1		+1	%
		XZ (YZ) axis – Temp. suffix K & L	-1		+1	%
Magnetic Angle phase error		$T_A = 25^\circ C$ – XY axis	-0.3		0.3	Deg.
		$T_A = 25^\circ C$ – XZ (YZ) axis	-10		10	Deg.
Thermal Drift of Magnetic Angle phase error		XY axis, XZ (YZ) axis		0.01		Deg.
XY – Intrinsic Linearity Error ⁽¹⁰⁾	Le	$T_A = 25^\circ C$ – factory trimmed “k”	-1		1	Deg
XZ (YZ) - Intrinsic Lin. Error ⁽¹⁰⁾	Le	$T_A = 25^\circ C$ – “k” not trimmed	-20	± 2.5	20	Deg
Analog Output Resolution	R_{DAC}	12b DAC (Theoretical, Noise free)		0.025		%VDD/LSB ₁₂
		INL (before EOL calibration)	-4		+4	LSB ₁₂
		DNL	0.05	1	3	LSB ₁₂
Output stage Noise		Clamped Output		0.05	0.075	%VDD
Noise pk-pk ⁽¹¹⁾		Slow mode, Filter=2		0.10	0.2	Deg
		Fast mode, Filter=0		0.15	0.25	Deg
Ratiometry Error (Analog output only)		$4.5V \leq V_{DD} \leq 5.5V$	-0.1		+0.1	%VDD
		$LT4V \leq V_{DD} \leq MT7V$	-1		+1	%VDD

⁷ 16 bits corresponds to 15 bits + sign. Internal computation is performed using 16 bits.

⁸ For instance, in case of a rotary position sensor application, Thermal Offset Drift #1 equal $\pm 60LSB_{15}$ yields to max. ± 0.3 Deg. angular error for the computed angular information (output of the DSP). This is only valid if $k = 1$. “MLX90360 Front-End Application Note” will be released for more details.

⁹ For instance, in case of a rotary position sensor application, Thermal Drift of Sensitivity Mismatch equal $\pm 0.5\%$ yields to max. ± 0.15 Deg. angular error for the computed angular information (output of the DSP). See “MLX90360 Front-End Application Note” for more details.

¹⁰ The Intrinsic Linearity Error refers to the IC itself (offset, sensitivity mismatch, orthogonality) taking into account an ideal rotating field for B_x and B_y . Once associated to a practical magnetic construction and the associated mechanical and magnetic tolerances, the output linearity error increases. However, it can be improved with the multi-point end-user calibration. The intrinsic Linearity Error for Magnetic angle XZ and YZ can be reduced through the programming of the k factor.. See “MLX90360 Front-End Application Note” & “MLX90360 Back-End Application Note” for more details.

¹¹ Noise pk-pk (peak-to-peak) is here intended as 6 times the Noise standard Deviation. The application diagram used is described in the recommended wiring. For detailed information, refer to section Filter in application mode (Section 14.5).

11. MLX90360 Magnetic Specification

DC Operating Parameters at VDD = 5V (unless otherwise specified) and for TA as specified by the Temperature suffix (E or K or L).

Parameter	Symbol	Test Conditions	Min	Typ	Max	Units
Magnetic Flux Density	B _x , B _y	$\sqrt{[B_x^2 + B_y^2]}$			70 ⁽¹²⁾	mT
Magnetic Flux Density	B _z ⁽¹⁴⁾				130	mT
Magnetic Field Norm	Norm	$\sqrt{[B_x^2 + B_y^2 + (B_z/1.2)^2]}$	20 ⁽¹³⁾	40		mT
IMC Gain ⁽¹⁴⁾	GainIMC		1.2	1.5	1.8	
Magnet Temperature Coefficient	TCm		-2400		0	ppm/°C

12. MLX90360 CPU & Memory Specification

The DSP is based on a 16 bit RISC μ Controller. This CPU provides 2.5 Mips while running at 10 MHz.

Parameter	Symbol	Test Conditions	Min	Typ	Max	Units
ROM				7		kB
RAM				256		B
EEPROM				128		B

¹² Above 70 mT, the IMC starts saturating yielding to an increase of the linearity error.

¹³ Below 20 mT, the performances slightly degrade due to a reduction of the signal-to-noise ratio, signal-to-offset ratio...

¹⁴ This is the magnetic gain linked to the Integrated Magneto Concentrator structure. It applies to B_x and B_y and not to z. This is the overall variation. Within one lot, the part to part variation is typically $\pm 10\%$ versus the average value of the IMC gain of that lot.

13. MLX90360 End-User Programmable Items

Parameter	Comments	Default Values		
		Standard	PPAR	# bit
Output mode	Define the output stage mode	4	4	3
DIAG	Diagnostic mode (Low/Hi)	0	0	1
ADIAG	Analog diagnostic option (Low/HiZ or HiZ/Hi)	0	0	1
HS	High speed mode (6MHz or 10MHz)	1	0	1
MAPXYZ	Mapping fields for output angle	MLX	MLX	3
CLAMP_HIGH	Clamping High (50%)	50%	10%	16
CLAMP_LOW	Clamping Low (50%)	50%	90%	16
FILTERFIRST	Filtering before linear correction	1h	1h	1
FILTER	Filter mode selection	0h	1h	2
k (SMISM)	Sensitivity mismatch factor	MLX	MLX	16
GAINMIN	Low threshold for virtual gain	00h	00h	8
GAINMAX	High threshold for virtual gain	29h	29h	8
PWMPOL	PWM polarity	0	N/A	1
PWMLATCH	PWM register latched on PWM edge	1	N/A	1
PWMT	PWM Frequency	1B58h	N/A	16
DP	Discontinuity point	0000h	0000h	15
CW	Enable Clock Wise direction	0h	0h	1
FHYST	Hysteresis filter	0h	0h	8
MELEXISID1	Melexis identification reference	MLX	MLX	16
MELEXISID2	Melexis identification reference	MLX	MLX	16
MELEXISID3	Melexis identification reference	MLX	MLX	16
CUSTOMERID4	Customer identification reference	0h	0h	16
3POINTS	Selection of correction method 3 or 16 pts	1h	1h	1
LNR_S0	3pts – Initial Slope	0h	0h	16
LNR_A_X	3pts – AX Coordinate	7FFFh	0	16
LNR_A_Y	3pts – AY Coordinate	0	10%	16
LNR_A_S	3pts – AS Coordinate	0	80%/360d	16
LNR_B_X	3pts – BX Coordinate	FFFFh	FFFFh	16
LNR_B_Y	3pts – BY Coordinate	0	0	16
LNR_B_S	3pts – BS Coordinate	0	0	16
LNR_C_X	3pts – CX Coordinate	FFFFh	FFFFh	16
LNR_C_Y	3pts – CY Coordinate	FFFFh	FFFFh	16
LNR_C_S	3pts – CS Coordinate	0	0	16
LNR_D_X	3pts – DX Coordinate	FFFFh	FFFFh	16
LNR_D_Y	3pts – DY Coordinate	FFFFh	FFFFh	16
LNR_D_S	3pts – DS Coordinate	0	0	16
W	16pts – Output angle range	0h	0h	4
LNR_Y0/ CUSTOMERID1	16pts – Y-coordinate point 0 / Cust. id reference	N/A	N/A	16
LNR_Y1/ CUSTOMERID2	16pts – Y-coordinate point 1 / Cust. id reference	N/A	N/A	16
LNR_Y2/ CUSTOMERID3	16pts – Y-coordinate point 2/ Cust. id reference	N/A	N/A	16
LNR_Yn	16pts – Y-coordinate point n	N/A	N/A	16
LNR_Y16	16pts – Y-coordinate point 16	N/A	N/A	16
HAMHOLE	Hamming code recovery	3131h	0	16
DRESONFAULT	Disables Reset on detected fault	1h	0h	1

DOUINFault	Disables Diagnostics reporting on detected fault	1h	0h	1
LOCK	Lock byte	00h	4Ch	8

14. Description of End-User Programmable Items

14.1. Output Mode

The MLX90360 output type is defined by the Output Mode parameter.

Parameter	Value	Description
Analog Output Mode	1	Analog Rail-to-Rail for $C_{out_{min}} = 47nF$
	2	Analog Rail-to-Rail for $C_{out_{max}} = 10nF$
	3	Analog Rail-to-Rail for $C_{out_{max}} = 68nF$
	4	Analog Rail-to-Rail for $C_{out_{max}} = 330nF$
PWM Output Mode	5	Low Side (NMOS)
	6	High Side (PMOS)
	7	Push-Pull

14.1.1. Analog Output Mode

The Analog Output Mode is a rail-to-rail and ratiometric output with a push-pull output stage configuration allows the use of a pull-up or pull-down resistor.

With respect to the application diagram described in section 16, Melexis recommendation is Analog Out Mode 4. Mode 1 is also compliant with this diagram.

14.1.2. PWM Output Mode

If PWM output mode is selected, the output signal is a digital signal with Pulse Width Modulation (PWM).

The PWM polarity is selected by the PWMPOL1 parameter:

- PWMPOL = 0 for a low level at 100%
- PWMPOL = 1 for a high level at 100%

The PWM frequency is selected by the PWMT parameter. The following table provides typical code for different target PWM frequency and for both low and high speed modes.

PWM Frequency Code (PWMT)				
Oscillator Mode	Pulse-Width Modulation Frequency (Hz)			
	100	200	500	1000
Low Speed ($Ck_{NOM} = 6.5$ MHz)	32500	16250	6500	3250
High Speed ($Ck_{NOM} = 10$ MHz)	50000	25000	10000	5000

The PWM Latch freezes the output value at the beginning of the PWM period. If not enabled the PWM output might be updated before the PMW period is finished, resulting in a inconsistent duty cycle.

Notes:

- A more accurate trimming can be performed to take into account initial tolerance of the main clock.
- The PWM frequency is subjected to the same tolerances as the main clock (see $\Delta^T Ck$).

14.2. Output Transfer Characteristic

There are 2 different possibilities to define the transfer function (LNR):

- With 4 arbitrary points (defined on X and Y coordinates) and 5 slopes
- With 17 equidistant points for which only the Y coordinates are defined.

Parameter	LNR type	Value	Unit
CLOCKWISE	Both	0 → CounterClockWise 1 → ClockWise	LSB
DP	Both	0 ... 359.9999	deg
LNR_A_X LNR_B_X LNR_C_X LNR_D_X	Only 4 pts	0 ... 359.9999	deg
LNR_A_Y LNR_B_Y LNR_C_Y LNR_D_Y	Only 4 pts	0 ... 100	%
LNR_S0 LNR_A_S LNR_B_S	Only 4 pts	0 ... 17	%/deg
LNR_C_S LNR_D_S	Only 4 pts	-17 ... 0 ... 17	%/deg
LNR_Y0 LNR_Y1 ... LNR_Y16	Only 16 pts	-50 ... + 150	%
W	Only 16 pts	65.5 ... 360	Deg
CLAMP_LOW	Both	0 ... 100	%
CLAMP_HIGH	Both	0 ... 100	%

14.2.1. Enable scaling Parameter (only for LNR type 4 pts)

This parameter enables to scale LNR_x_Y from -50% - 150% according to the following formula

$$(\text{Scaled Out})\%V_{DD} = 2 \times \text{Out}\%V_{DD} - 50\%$$

14.2.2. CLOCKWISE Parameter

The CLOCKWISE parameter defines the magnet rotation direction.

- CCW is the defined by the 1-4-5-8 pin order direction for the SOIC8 package and 1-8-9-16 pin order direction for the TSSOP16 package.
- CW is defined by the reverse direction: 8-5-4-1 pin order direction for the SOIC8 and 16-9-8-1 pin order direction for the TSSOP16 package.

Refer to the drawing in the sensitive spot positioning sections (Section 19.3)

14.2.3. Discontinuity Point (or Zero Degree Point)

The Discontinuity Point defines the 0° point on the circle. The discontinuity point places the origin at any location of the trigonometric circle. The DP is used as reference for all the angular measurements.

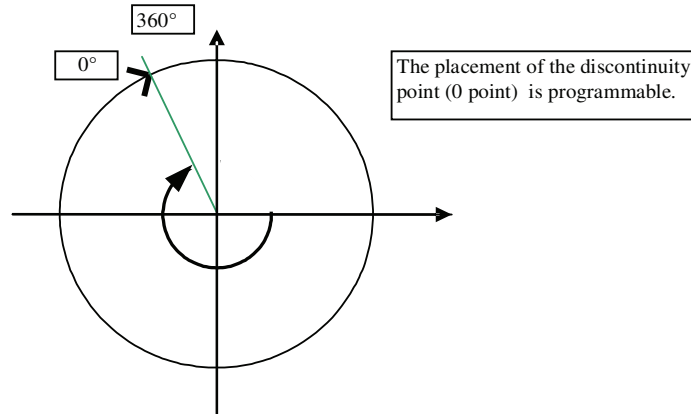

Figure 7 - Discontinuity Point Positioning

14.2.4. 4-Pts LNR Parameters

The LNR parameters, together with the clamping values, fully define the relation (the transfer function) between the digital angle and the output signal.

The shape of the MLX90360 transfer function from the digital angle value to the output voltage is described by the drawing below. Six segments can be programmed but the clamping levels are necessarily flat.

Two, three, or even six calibration points are then available, reducing the overall non-linearity of the IC by almost an order of magnitude each time. Three or six calibration point will be preferred by customers looking for excellent non-linearity figures. Two-point calibrations will be preferred by customers looking for a cheaper calibration set-up and shorter calibration time.

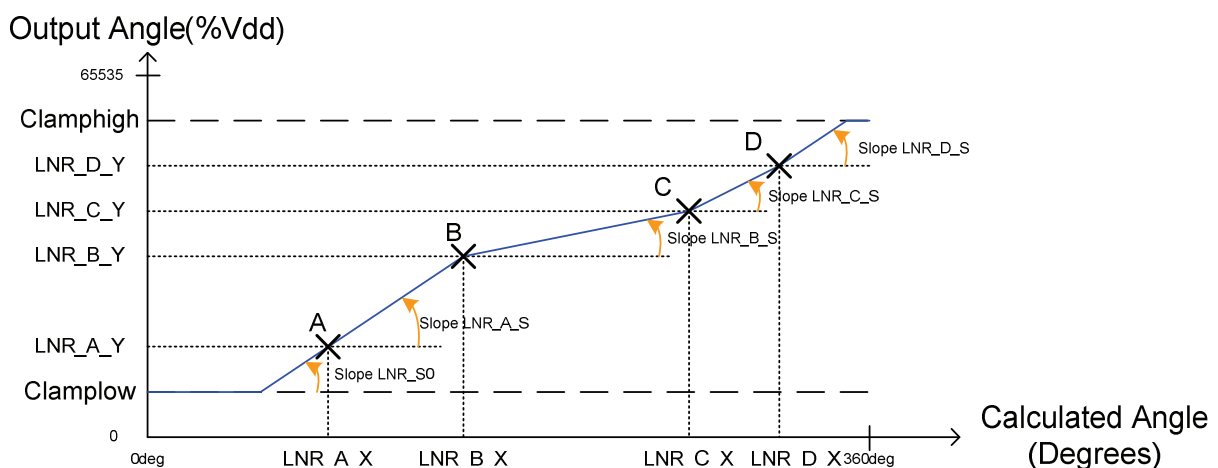

Figure 8

14.2.5. 17-Pts LNR Parameters

The LNR parameters, together with the clamping values, fully define the relation (the transfer function) between the digital angle and the output signal.

The shape of the MLX90360 transfer function from the digital angle value to the output voltage is described by the drawing below. In the 16-Pts mode, the output transfer characteristic is Piece-Wise-Linear (PWL).

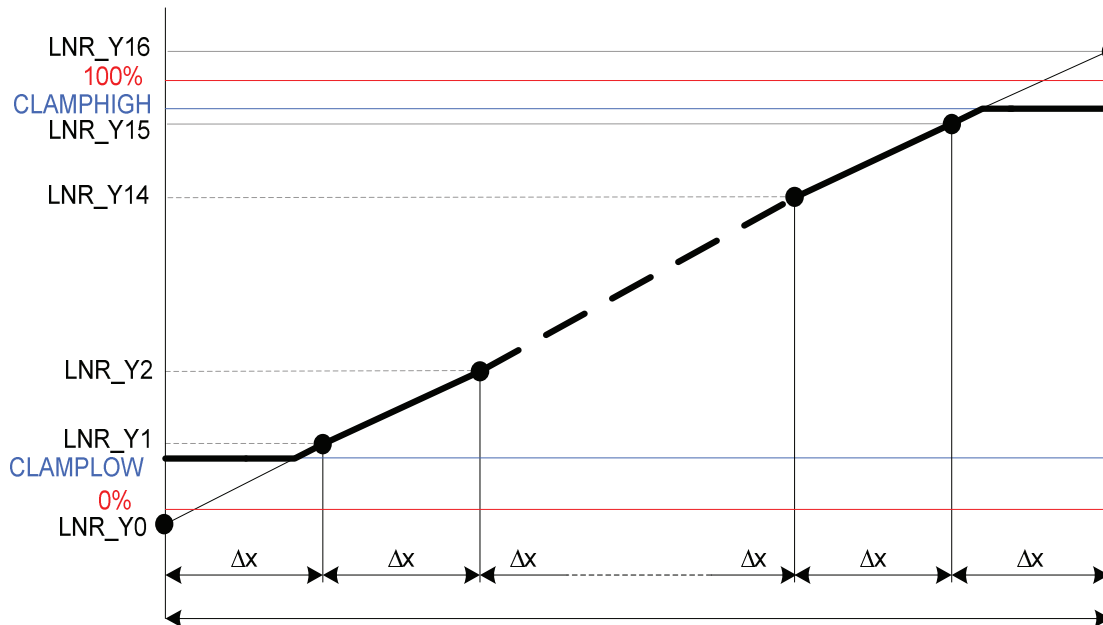

Figure 9 - Input range from 65.5° up to 360°

All the Y-coordinates can be programmed from -50% up to +150% to allow clamping in the middle of one segment (like on the figure), but the output value is limited to CLAMPLOW and CLAMPHIGH values.

Between two consecutive points, the output characteristic is interpolated.

The parameter W determines the input range on which the 17 points (16 segments) are uniformly spread:

W	Range	Δx
0 (0000b)	360.0deg	22.5deg
1	320.0deg	20.0deg
2	288.0deg	18.0deg
3	261.8deg	16.4deg
4	240.0deg	15.0deg
5	221.5deg	13.8deg
6	205.7deg	12.9deg
7	192.0deg	12.0deg

W	Range	Δx
8	180.0deg	11.3deg
9	144.0deg	9.0deg
10	120.0deg	7.5deg
11	102.9deg	6.4deg
12	90.0deg	5.6deg
13	80.0deg	5.0deg
14	72.0deg	4.5deg
15 (1111b)	65.5deg	4.1deg

Outside of the selected range, the output will remain in clamping levels.

14.2.6. CLAMPING Parameters

The clamping levels are two independent values to limit the output voltage range. The CLAMPLOW parameter adjusts the minimum output voltage level. The CLAMPHIGH parameter sets the maximum output voltage level. Both parameters have 16 bits of adjustment and are available for both LNR modes. In analog mode, the resolution will be limited by the D/A converter (12 bits) to 0.024%V_{DD}. In PWM mode, the resolution will be 0.024%DC.

14.3. Identification

Parameter	Value
MELEXISID1	0 ... 65535
MELEXISID2	0 ... 65535
MELEXISID3	0 ... 65535
CUSTOMERID1	0 ... 65535
CUSTOMERID2	0 ... 65535
CUSTOMERID3	0 ... 65535
CUSTOMERID4	0 ... 65535

Identification number: 64 bits (4 words) freely useable by Customer for traceability purpose.

Those 64 bits are only available if the 3pts-LNR. For the 16-Pts LNR, the corresponding EEPROM area of CUSTOMERID1,2,3 are used by the LNR function.

14.4. Sensor Front-End

Parameter	Value
HS	0 = Slow mode 1 = Fast mode
MAPXYZ	0 .. 5
k (or SMISM)	0 .. 65535
GAINMIN GAINMAX	0 ... 41

14.4.1. HIGHSPEED Parameter

The HIGHSPEED parameter defines the main frequency for the DSP.

- HIGHSPEED = 0 selects the Slow mode with a 6.5 MHz master clock (nominal).
- HIGHSPEED = 1 selects the Fast mode with a 10.0 MHz master clock (nominal).

For better noise performance, the Slow Mode must be enabled.

14.4.2. MAPXYZ

The MAPXYZ parameter defines which fields are used to calculate the angle. The different possibilities are described in the tables below.

MAPXYZ	Angle definition
0	$\angle XY = \angle(k \cdot B_x, B_y)$
1	$\angle YX = \angle(B_x, k \cdot B_y)$
2	$\angle XZ = \angle(k \cdot B_x, B_z)$
3	$\angle ZX = \angle(B_z, k \cdot B_z)$
4	$\angle YZ = \angle(k \cdot B_y, B_z)$
5	$\angle ZY = \angle(B_y, k \cdot B_z)$

14.4.3. k parameter

The k parameter defines the sensitivity mismatch between the 2 selected axis used for the angular calculation. Its value is defined through an unsigned 16 bits value from 0.0 to 1.0. Typical values are between 0.5 and 1.

The MAPXYZ is defined in factory to be 0 or 1. For an end-user XY-application, don't overwrite this parameter.

14.4.4. GAINMIN and GAINMAX Parameters

GAINMIN and GAINMAX define the boundaries within the virtual gain setting is allowed to vary. Outside this range, the output is set in diagnostic mode.

14.5. Filter

Parameter	Value
FILTER	0 ... 2
FHYST	0 ... 31
FILTERFIRST	0 or 1

The MLX90360 includes 2 types of filters:

- Hysteresis Filter: programmable by the FHYST parameter
- Low Pass FIR Filters controlled with the FILTER parameter

Note: if the parameter FILTERFIRST is set to "1", the filtering is active on the digital angle (prior to the output mapping). If set to "0", the filtering is active on the output transfer function (after the output mapping).

Melexis recommends to program FILTERFIRST to 1 in order to be compliant with any Linear compensation on the Output.

14.5.1. Hysteresis Filter

The FHYST parameter is a hysteresis filter. The output value of the IC is not updated when the digital step is smaller than the programmed FHYST parameter value. The output value is modified when the increment is bigger than the hysteresis. The hysteresis filter reduces therefore the resolution to a level compatible with the internal noise of the IC. The hysteresis must be programmed to a value close to the noise level.

14.5.2. FIR Filters

The MLX90360 features 2 FIR filter modes controlled with Filter = 1...2. Filter = 0 corresponds to no filtering. The transfer function is described below:

$$y_n = \frac{1}{\sum_{i=0}^j a_i} \sum_{i=0}^j a_i x_{n-i}$$

The filters characteristics are given in the following table:

Filter No	0	1	2
j	0	1	3
Type	Disable	Finite Impulse Response	
Coefficients a _i	1	11	1111
Title	No filter	ExtraLight	Light
99% Response Time	1	2	4
Efficiency RMS (dB)	0	3.0	6.0

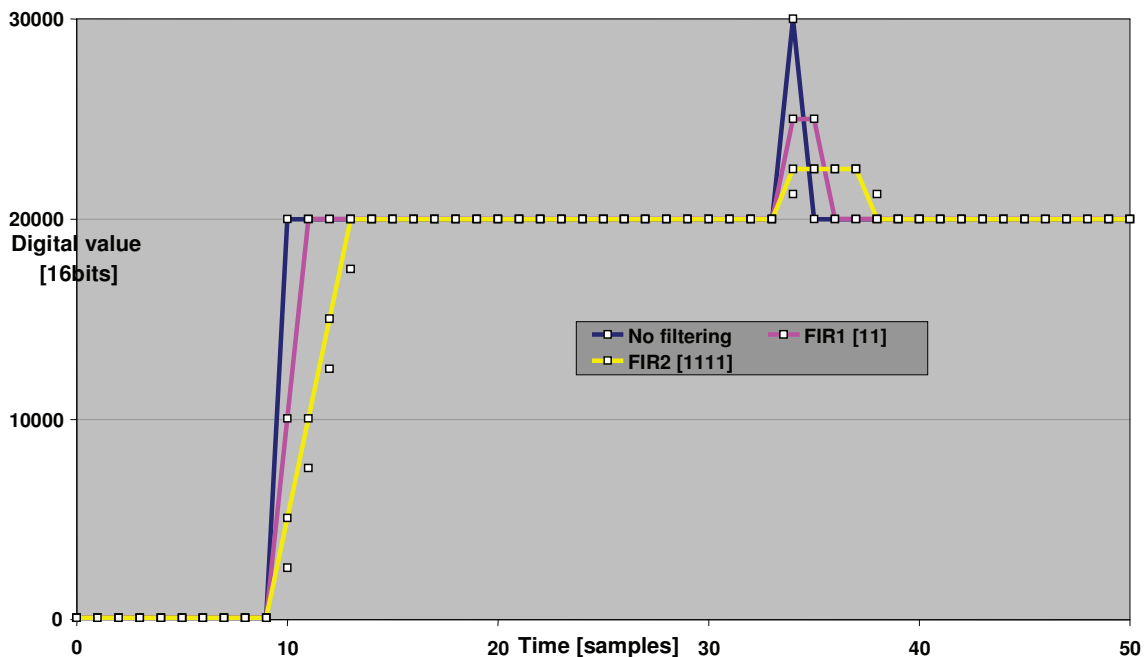

Figure 10 - Step and impulse response of the different filters

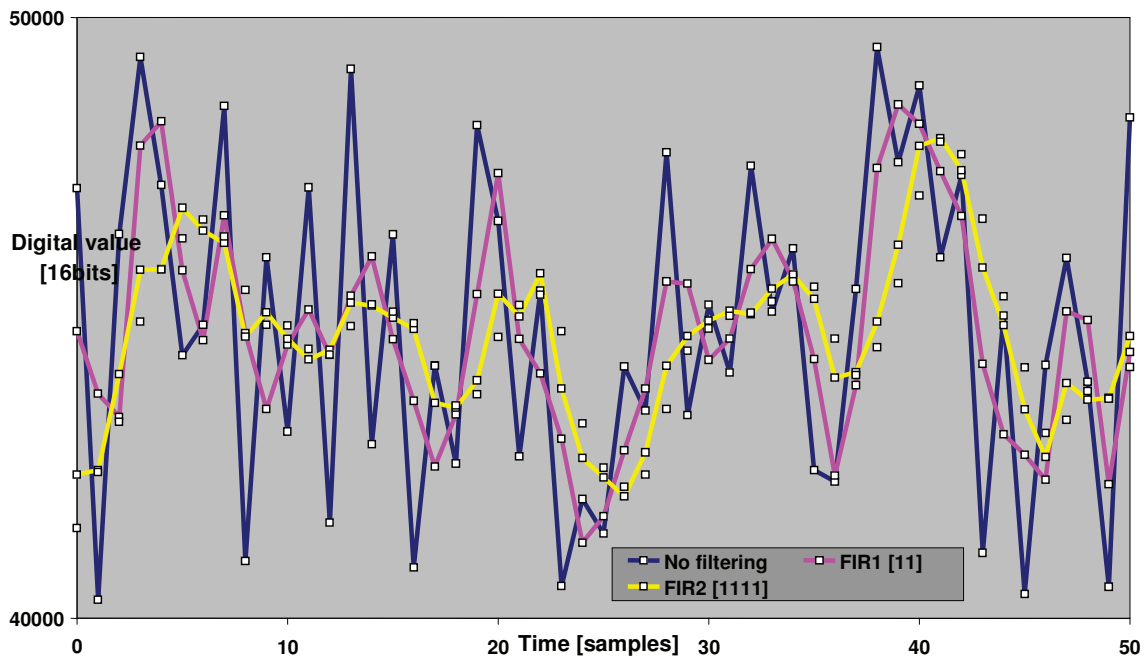

Figure 11 - Noise response of the different filter

14.6. Programmable Diagnostic Settings

Parameter	Value	Unit
DIAG	0 or 1	
ADIAG	0 or 1	
HAMHOLE	0 or 3131h	

14.6.1. Fixed-level diagnostic reporting

In analog output mode

DIAG and ADIAG parameters allow selecting all diagnostic modes:

Mode	Type	Description
With pull-up ADIAG = 0	DIAG = 0 DIAG = 1	Diagnostic Low Diagnostic Hi (HiZ + pull-up)
With pull-down ADIAG = 1	DIAG = 0 DIAG = 1	Diagnostic Low (HiZ + pull-down) Diagnostic Hi

In PWM output mode

Only parameter DIAG is used:

Digital mode	Type	Description
5 – Open drain NMOS	DIAG = 0	Diagnostic Low
	DIAG = 1	Diagnostic Hi (HiZ + pull-up)
6 – Open drain PMOS	DIAG = 0	Diagnostic Low (HiZ + pull-down)
	DIAG = 1	Diagnostic Hi
7 – Push-pull output	DIAG = 0	Diagnostic Low
	DIAG = 1	Diagnostic Hi

To activate fixed-level diagnostic reporting, the following parameters should be programmed according to the table below:

Parameter	Value
DRESONFAULT ⁽¹⁵⁾	0h
DOUTINFAULT ⁽¹⁵⁾	0h

14.6.2. PWM Diagnostic reporting

To select a defined duty cycle for different fault modes, the PWMDiagMode register should be configured as follows:

PWMDIAGMode			Diagnostic Level		
3	2	1:0			
EN	Type	Level[1:0]			
0	x	x	Diag Low or Diag Hi depending on DIAG parameter (OSMOD)		
		Diagnostic Type	WeakMagnet (%DC)	LostMagnet(%DC)	Failure (%DC)
		Trigger conditions	GAINmax < GAIN	41 < GAIN	Other Diagnostics
1	0	00	0.5 x ClampLow	0.5 x ClampLow	0.25 x ClampLow
		01	0.5 x ClampLow	0.25 x ClampLow ⁽¹⁶⁾	0.25 x ClampLow
		10	0.25 x ClampLow	0.25 x ClampLow	0.25 x ClampLow
		11	0.5 x ClampLow	0.5 x ClampLow	static low
	1	00	100% - 0.5 x (100% - ClampHigh)	100% - 0.5 x (100% - ClampHigh)	100% - 0.25 x (100% - ClampHigh)
		01	100% - 0.5 x (100% - ClampHigh)	100% - 0.25 x (100% - ClampHigh) ⁽¹⁶⁾	100% - 0.25 x (100% - ClampHigh)
		10	100% - 0.25 x (100% - ClampHigh)	100% - 0.25 x (100% - ClampHigh)	100% - 0.25 x (100% - ClampHigh)
		11	100% - 0.5 x (100% - ClampHigh)	100% - 0.5 x (100% - ClampHigh)	static high

Warning: Diagnostic reporting in PWM is not compatible with fixed-level diagnostics enabling. To activate diagnostic reporting in PWM, the following parameters should be programmed according to the table below:

Parameter	Value
DRESONFAULT ⁽¹⁷⁾	1h
DOUTINFAULT ⁽¹⁷⁾	1h

¹⁵ To enable this configuration from Melexis 90360 user interface, program ResetOnFault[2] to 1

¹⁶ This condition will be reported only if the Normtoolow diagnostic is disabled

¹⁷ To enable this configuration from Melexis 90360 user interface, program ResetOnFault[2] to 0

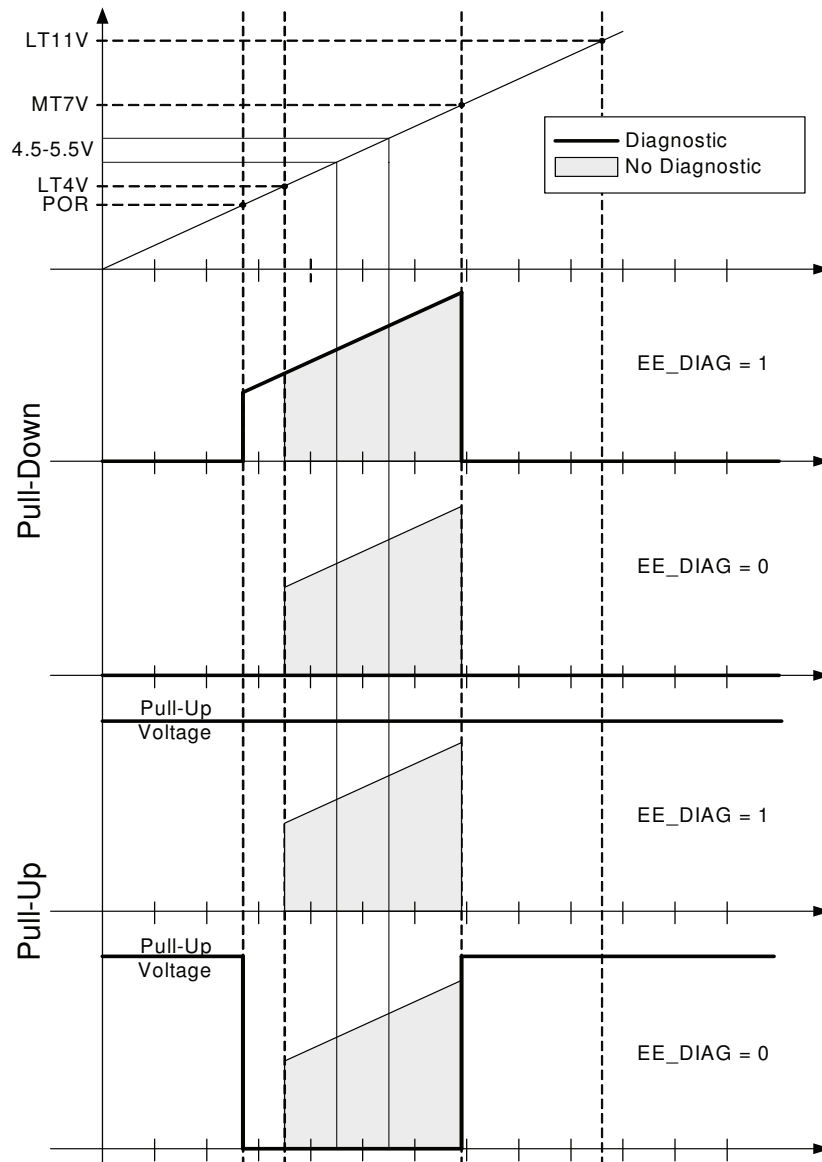

Figure 12 - Output voltage in diagnostic modes over supply voltage.

14.6.3. HAMHOLE Parameter

The HAMHOLE parameter enables or disables the memory recovery based on Hamming codes in case of EEPROM CRC error. By default, the memory recovery and EEPROM CRC check are disabled (Hamhole=3131h). These two features are enabled automatically when locking the part (see paragraph 14.7).

14.7. Lock

The LOCK parameter locks all the parameters set by the user. Once the lock is enabled, it is not possible to change the EEPROM values anymore as PTC communication in writing mode is not available anymore.

Note that the lock bit should be set by the solver function "MemLock".

14.8. EEPROM endurance

Although the EEPROM is used for Calibration Data Storage (similarly to an OTPROM), the MLX90360 embedded EEPROM is qualified to guarantee an endurance of minimum 1000 write cycles at 125°C for (engineering/calibration purpose).