



Chipsmall Limited consists of a professional team with an average of over 10 year of expertise in the distribution of electronic components. Based in Hongkong, we have already established firm and mutual-benefit business relationships with customers from,Europe,America and south Asia,supplying obsolete and hard-to-find components to meet their specific needs.

With the principle of “Quality Parts,Customers Priority,Honest Operation,and Considerate Service”,our business mainly focus on the distribution of electronic components. Line cards we deal with include Microchip,ALPS,ROHM,Xilinx,Pulse,ON,Everlight and Freescale. Main products comprise IC,Modules,Potentiometer,IC Socket,Relay,Connector.Our parts cover such applications as commercial,industrial, and automotives areas.

We are looking forward to setting up business relationship with you and hope to provide you with the best service and solution. Let us make a better world for our industry!



## Contact us

Tel: +86-755-8981 8866 Fax: +86-755-8427 6832

Email & Skype: info@chipsmall.com Web: www.chipsmall.com

Address: A1208, Overseas Decoration Building, #122 Zhenhua RD., Futian, Shenzhen, China



### Features and Benefits

- Operating Voltage from 2.7V to 24V
- Two Integrated Hall plates for Direction Detection
- Latching Magnetic Characteristics
- Speed & Direction Open-Drain Outputs
- Direction Output updated prior Speed Output
- Excellent Temperature Stability
- Reverse Supply Voltage Protection
- Output Current Limitation and Auto-Shutoff
- Under-Voltage Lockout Protection

### Application Examples

- Windows lifter with Anti-Pinch feature
- Rotation speed & direction detection
- Linear speed & direction detection
- Angular position detection
- Power closures with Anti-Pinch features

### Ordering Information

Part No.	Temperature Code	Sensitivity	Package Code	Packing Form
MLX92251LSE-AAA-000-RE	L (-40°C to 150°C)	+/- 7.5 mT	SE (TSOT-5L)	RE (Tape & Reel)
MLX92251LSE-ABA-000-RE	L (-40°C to 150°C)	+/- 2.5 mT	SE (TSOT-5L)	RE (Tape & Reel)

### 1 Functional Diagram

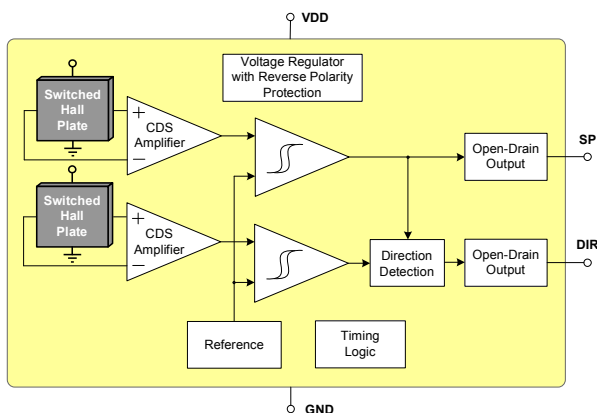

### 2 General Description

The Melexis MLX92251 is a second generation Hall-effect dual latch designed in mixed signal CMOS technology. The device integrates a voltage regulator, two Hall sensors with advanced offset cancellation system and two open-drain output drivers, all in a single package.

Two Hall plates are integrated on the same piece of silicon, thus using the high precision of the wafer fabrication process to ensure a fixed

spacing of 1.45mm between the sensing elements. The first Hall plate signal is used to provide the speed signal output. The combination of both the first and second Hall plate signals is then internally processed to directly deliver a direction signal output.

The MLX92251 shares the MLX922xx-based platform, synonym of high performance in terms of electrical specification, magnetic specification and protection level.

With latching magnetic characteristics, the speed (SP) output is turned low or high respectively with a sufficiently strong South or North pole facing the package top side. When removing the magnetic field, the device keeps its previous state.

The direction (DIR) output is latched in Low or High state depending on the movement direction of the applied magnetic field, as a result of certain magnetic pulse sequence on both Hall sensors.

The MLX92251 is delivered in a Green compliant 5-pin Thin Small Outline Transistor (TSOT) for surface-mount process.

## Table of Contents

<b>1 Functional Diagram .....</b>	<b>1</b>
<b>2 General Description.....</b>	<b>1</b>
<b>3 Glossary of Terms .....</b>	<b>3</b>
<b>4 Absolute Maximum Ratings .....</b>	<b>3</b>
<b>5 General Electrical Specifications .....</b>	<b>4</b>
<b>6 Magnetic Specifications .....</b>	<b>5</b>
6.1 MLX92251LSE-AAA-000 .....	5
6.2 MLX92251LSE-ABA-000 .....	5
<b>7 Output Behaviour versus Magnetic Pole .....</b>	<b>6</b>
<b>8 Application Information.....</b>	<b>7</b>
8.1 Default Application Schematic .....	7
8.2 Recommended Application Schematic for ISO7637-2 (pulses 5a and 5b) .....	7
8.3 Speed (SP) Output Behavior vs. BOP/BRP .....	7
8.4 Output Jitter, Speed Signal Delay and Direction Detection.....	8
8.5 UV lockout and POR behaviour.....	8
<b>9 Performance Graphs.....</b>	<b>9</b>
9.1 Magnetic parameters vs. $T_A$ .....	9
9.2 Magnetic parameters vs. $V_{DD}$ .....	9
9.3 $V_{DSON}$ vs. $T_A$ .....	9
9.4 $V_{DSON}$ vs. $V_{DD}$ .....	9
9.5 $I_{DD}$ vs. $T_A$ .....	9
9.6 $I_{DD}$ vs. $V_{DD}$ .....	9
9.7 $I_{LEAK}$ vs. $T_A$ .....	10
9.8 $I_{LEAK}$ vs. $V_{DD}$ .....	10
9.9 Power Derating vs. $T_A$ .....	10
<b>10 Standard information regarding manufacturability of Melexis products with different soldering processes .....</b>	<b>11</b>
<b>11 ESD Precautions .....</b>	<b>11</b>
<b>12 SE Package Information .....</b>	<b>12</b>
12.1 Pin Definitions and Descriptions.....	12
<b>13 Disclaimer .....</b>	<b>13</b>



### 3 Glossary of Terms

MilliTesla (mT), Gauss	Units of magnetic flux density: 1mT = 10 Gauss
RoHS	Restriction of Hazardous Substances
TSOT	Thin Small Outline Transistor (TSOT package) – also referred with the Melexis package code “SE”
ESD	Electro-Static Discharge

### 4 Absolute Maximum Ratings

Parameter	Symbol	Value	Units
Supply Voltage	$V_{DD}$	+27	V
Supply Current	$I_{DD}$	+20	mA
Reverse Supply Voltage	$V_{DDREV}$	-27	V
Reverse Supply Current	$I_{DDREV}$	-20	mA
Output Voltage	$V_{OUT}$	+27	V
Output Current	$I_{OUT}$	+20	mA
Reverse Output Voltage	$V_{OUTREV}$	-0.5	V
Reverse Output Current	$I_{OUTREV}$	-50	mA
Operating Temperature Range	$T_A$	-40 to +150	C
Storage Temperature Range	$T_S$	-55 to +165	C
Maximum Junction Temperature	$T_J$	+165	C
ESD Sensitivity – HBM <sup>(1)</sup>	-	2500	V
ESD Sensitivity – CDM <sup>(2)</sup>	-	1000	V
Magnetic Flux Density	B	Unlimited	mT

Table 1. Absolute maximum ratings

*Exceeding the absolute maximum ratings may cause permanent damage.  
Exposure to absolute-maximum-rated conditions for extended periods may affect device reliability.*

<sup>1</sup> Human Body Model according AEC-Q100-002 standard.  
<sup>2</sup> Charged Device Model according AEC-Q100-011 standard.

## 5 General Electrical Specifications

DC Operating Parameters  $T_A = -40^{\circ}\text{C}$  to  $150^{\circ}\text{C}$ ,  $V_{DD} = 2.7\text{V}$  to  $24\text{V}$  (unless otherwise specified)

Parameter	Symbol	Test Conditions	Min	Typ <sup>(1)</sup>	Max	Units
Supply Voltage	$V_{DD}$	Operating	2.7	-	24	V
Supply Current	$I_{DD}$	$V_{DD} = 12\text{V}$	3	4.5	7	mA
Reverse Supply Current	$I_{DDREV}$	$V_{DD} = -18\text{V}$			1	mA
Output Leakage Current	$I_{OFF}$	$V_{OUT} = 12\text{V}$ , $V_{DD} = 12\text{V}$ , $B < B_{RP}$		0.1	10	$\mu\text{A}$
Output Saturation Voltage	$V_{OUTS}$	$B > B_{OP}$ , $I_{OUT} = 10\text{mA}$		0.2	0.5	V
Output Rise/Fall Time <sup>(2,3)</sup>	$t_R / t_F$	$V_{DD} = 12\text{V}$ , $V_{PU}^{(4)} = 5\text{V}$ , $R_{PU} = 1\text{k}\Omega$ , $C_L = 50\text{pF}$	0.1	0.3	1	$\mu\text{s}$
Output Current Limit	$I_{CL}$	$B > B_{OP}$ , $V_{OUT} = 12\text{V}$	14	25	44	mA
Output ON Time under Current Limit conditions <sup>(5)</sup>	$t_{CLON}$	$B > B_{OP}$ , $V_{PU} = 12\text{V}$ , $R_{PU} = 100\Omega$	150	230		$\mu\text{s}$
Output OFF Time under Current Limit conditions <sup>(5)</sup>	$t_{CLOFF}$	$B > B_{OP}$ , $V_{PU} = 12\text{V}$ , $R_{PU} = 100\Omega$		3.5		ms
Chopping Frequency	$f_{CHOP}$			400		kHz
Speed Signal Delay <sup>(2,6)</sup>	$t_{SPD}$		0.4	0.85	1.6	$\mu\text{s}$
Output Refresh Period	$t_{PER}$		3.2	5	8.4	$\mu\text{s}$
Output Jitter (p-p value) <sup>(2)</sup>	$t_{JITTER}$	Over 1000 successive output switching events @1kHz square wave, $B_{PEAK} = 50\text{mT}$ , $t_{RISE} = t_{FALL} \leq 100\mu\text{s}$		$\pm 2.6$		$\mu\text{s}$
Maximum Switching Frequency <sup>(2,7)</sup>	$f_{SW}$	$\geq 30\text{mT}$ square wave magnetic field	40	66		kHz
Power-On Time <sup>(8)</sup>	$t_{PON}$	$V_{DD} = 5\text{V}$ , $dV_{DD}/dt > 2\text{V}/\mu\text{s}$		16	35	$\mu\text{s}$
Under-voltage Lockout Threshold	$V_{UVL}$		2.2	2.4	2.7	V
Under-voltage Lockout Reaction time <sup>(2)</sup>	$t_{UVL}$			1		$\mu\text{s}$
SE Package Thermal Resistance	$R_{TH}$	Single layer (1S) JEDEC board		300		$^{\circ}\text{C}/\text{W}$

Table 2: electrical specifications

1 Typical values are defined at  $T_A = +25^{\circ}\text{C}$  and  $V_{DD} = 12\text{V}$

2 Based on device characterization results, not subject to production test

3 Measured between  $0.1 \cdot V_{PU}$  and  $0.9 \cdot V_{PU}$

4  $R_{PU}$  and  $V_{PU}$  are respectively the external pull-up resistor and pull-up power supply

5 If the Output is in Current Limitation longer than  $t_{CLON}$  the Output is switched off in high-impedance state. The Output returns back in active state at next reaching of  $B_{OP}$  or after  $t_{CLOFF}$  time interval

6 Controlled delay between direction (DIR) signal update and speed (SP) signal update

7 Maximum switching frequency corresponds to the maximum frequency of the applied magnetic field which is detected without loss of pulses

8 The Power-On Time represents the time from reaching  $V_{DD} = 2.7\text{V}$  to the first refresh of the SP output

## 6 Magnetic Specifications

### 6.1 MLX92251LSE-AAA-000

DC Operating Parameters  $V_{DD} = 2.7V$  to  $24V$  and  $T_A = -40^{\circ}C$  to  $150^{\circ}C$  (unless otherwise specified)

Parameter	Symbol	Test Conditions	Min	Typ	Max	Units
Operating Point	$B_{OP}$		5	7.5	10	mT
Release Point	$B_{RP}$		-10	-7.5	-5	mT
Magnetic Matching	$B_{MATCH}$	$B_{OP1} - B_{OP2}$ OR $B_{RP1} - B_{RP2}$ , $T_A = 25^{\circ}C$	-2		2	mT
		$B_{OP1} - B_{OP2}$ OR $B_{RP1} - B_{RP2}$	-3		3	mT
Magnetic Offset	$B_{OFF}$	$(B_{OP1} + B_{RP1}) / 2$ , $(B_{OP2} + B_{RP2}) / 2$	-2		2	mT
Temperature Coefficient <sup>(1)</sup>	TC			0		ppm/ $^{\circ}C$
Hall Sensors Spacing	-			1.45		mm

Table 3: Magnetic specifications

### 6.2 MLX92251LSE-ABA-000

DC Operating Parameters  $V_{DD} = 2.7V$  to  $24V$  and  $T_A = -40^{\circ}C$  to  $150^{\circ}C$  (unless otherwise specified)

Parameter	Symbol	Test Conditions	Min	Typ	Max	Units
Operating Point	$B_{OP}$		0.6	2.5	4.5	mT
Release Point	$B_{RP}$		-4.5	-2.5	-0.6	mT
Magnetic Matching	$B_{MATCH}$	$B_{OP1} - B_{OP2}$ OR $B_{RP1} - B_{RP2}$ , $T_A = 25^{\circ}C$	-2		2	mT
		$B_{OP1} - B_{OP2}$ OR $B_{RP1} - B_{RP2}$	-3		3	mT
Magnetic Offset	$B_{OFF}$	$(B_{OP1} + B_{RP1}) / 2$ , $(B_{OP2} + B_{RP2}) / 2$	-2		2	mT
Temperature Coefficient <sup>(1)</sup>	TC			-1100		ppm/ $^{\circ}C$
Hall Sensors Spacing	-			1.45		mm

Table 3: Magnetic specifications

<sup>1</sup> Temperature coefficient value is guaranteed by design and verified by characterization and is calculated using the following formula

$$\frac{B_{T_2} - B_{T_1}}{B_{25^{\circ}C}} \times 10^6, \text{ ppm } / ^{\circ}C; T_1 = -40^{\circ}C; T_2 = 150^{\circ}C$$

### 7 Output Behaviour versus Magnetic Pole

DC Operating Parameters  $T_A = -40^{\circ}\text{C}$  to  $150^{\circ}\text{C}$ ,  $V_{DD} = 2.7\text{V}$  to  $24\text{V}$  (unless otherwise specified)

Parameter	Test Conditions	SP Output State
South pole	$B > B_{OP}$	Low
North pole	$B < B_{RP}$	High <sup>(2)</sup>

Table 4: Output behaviour versus magnetic pole <sup>(3)</sup>

Direction	Step	H1	H2	DIR Output State
<b>CCW</b>	$n_x$	N	S	<b>Low</b>
	$n_{(x+1)}$	N	N	
	$n_{(x+2)}$	S	N	
	$n_{(x+3)}$	S	S	
	$n_{(x+4)} \equiv n_x$	N	S	

Direction	Step	H1	H2	DIR Output State
<b>CW</b>	$n_x$	N	S	<b>High <sup>(4)</sup></b>
	$n_{(x+1)}$	S	S	
	$n_{(x+2)}$	S	N	
	$n_{(x+3)}$	N <sup>(4)</sup>	N <sup>(4)</sup>	
	$n_{(x+4)} \equiv n_x$	N	S	

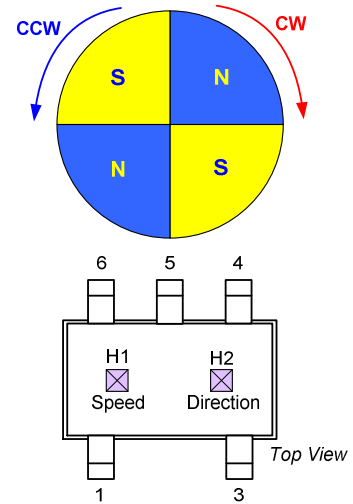

<sup>2</sup> Default SP output state during power-up

<sup>3</sup> Magnetic pole applied perpendicularly to Hall plate "H1", facing the branded/top side of the package

<sup>4</sup> Default magnetic and DIR output state during power-up

## 8 Application Information

### 8.1 Default Application Schematic

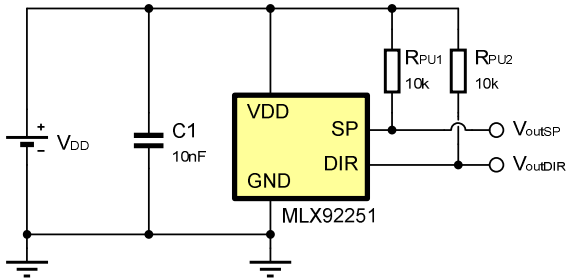

### 8.2 Recommended Application Schematic for ISO7637-2 (pulses 5a and 5b)

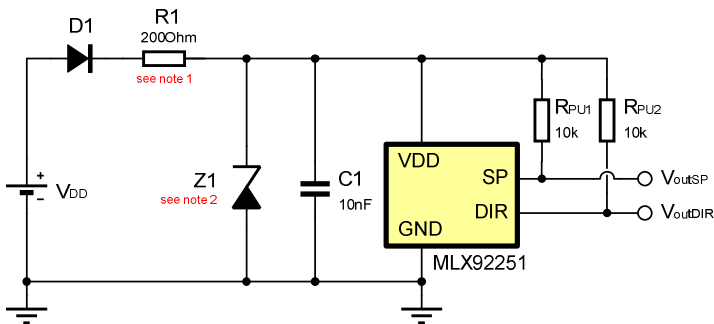

**Notes:**

1. Recommended for conducted transients on supply line above 32V with duration above 500ms.
2. Recommended for conducted transients on supply line above 36V.
3. Recommended zener diode Z1 is BZX55C27 or equivalent.

### 8.3 Speed (SP) Output Behavior vs. $B_{OP}/B_{RP}$

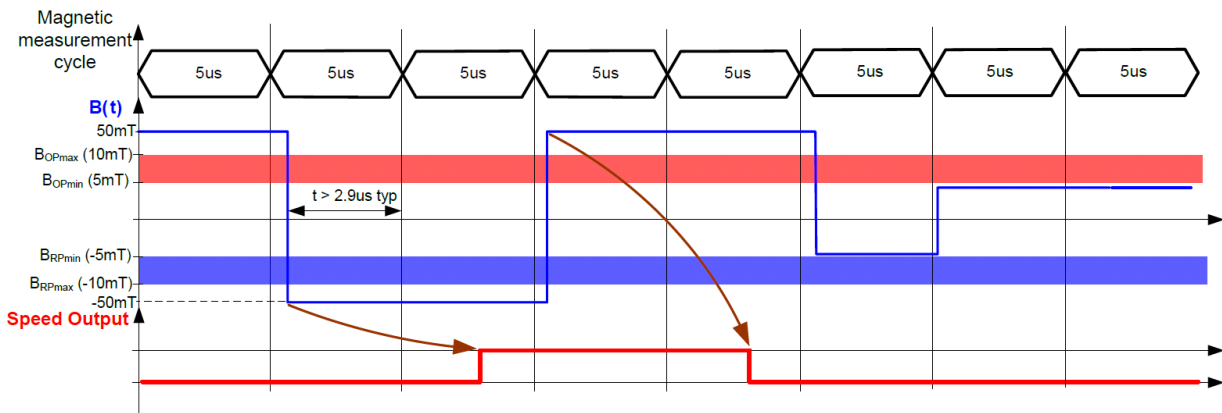

Note: The decision for output update is taken at the end of each magnetic measurement cycle



**8.4 Output Jitter, Speed Signal Delay and Direction Detection**

**Output Jitter**

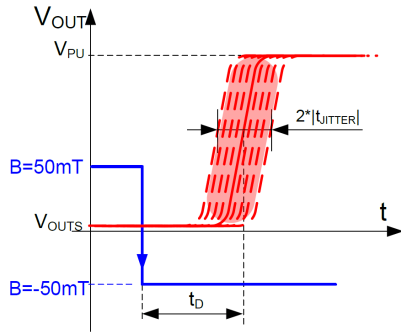

Note:  $t_D=8\mu s$  typ for DIR output and  $t_D=8.85\mu s$  typ for SP output, based on simulation

**Direction Detection**

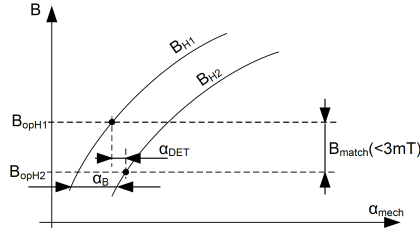

$\alpha_{DET}$  is the angular difference between H1 and H2 magnetic threshold crossing points;  
 $B_{H1}$  ( $B_{H2}$ ) is the magnetic field facing Hall plate H1 (H2) as a function of the mechanical angle  $\alpha_{mech}$ ;  
 $\alpha_B$  is the angular difference between  $B_{H1}$  and  $B_{H2}$ ;  
 $B_{match} < 3mT$  is the magnetic matching (see Magnetic Specifications section)  
 $dB/d\alpha$  is the magnetic field gradient  
 $f_{Bmax}$  is the maximum magnetic field frequency at which the direction will be detected without error  
 $\Delta t$  is the time difference between H1 and H2 magnetic threshold crossing points;

For example, if  $\alpha_B = 5^\circ$  and  $dB/d\alpha > 1mT/^\circ$ ;  
 for MLX92251  $\Delta t = 10\mu s$  (definitely  $> 2 * t_{JITTER}$ ) could be assumed;  
 The calculated  $f_{Bmax} = 555Hz$ .

**Speed Signal Delay**

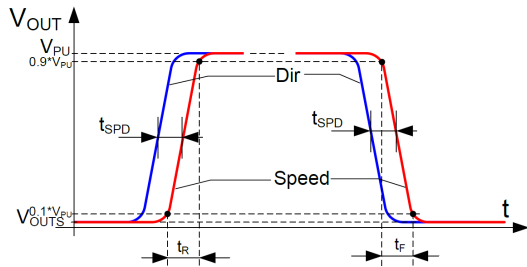

**8.5 UV lockout and POR behaviour**

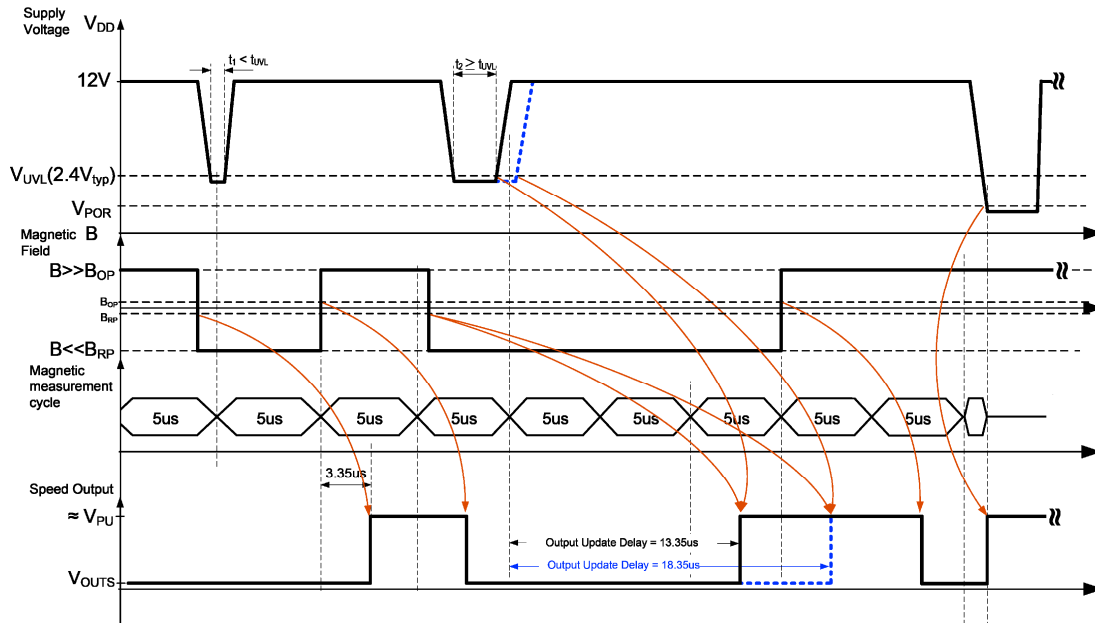

NOTE: Start-up behaviour feature does not occur after under-voltage lockout.  $V_{POR} \leq 2V$  (based on device characterization results).

## 9 Performance Graphs

### 9.1 Magnetic parameters vs. $T_A$

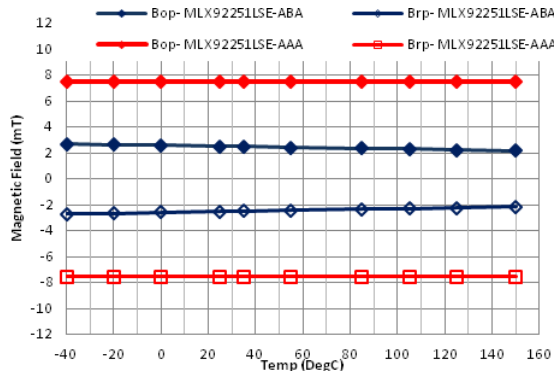

### 9.2 Magnetic parameters vs. $V_{DD}$

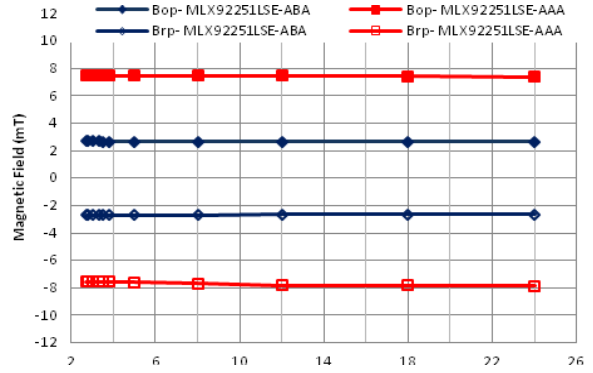

### 9.3 $V_{DSON}$ vs. $T_A$

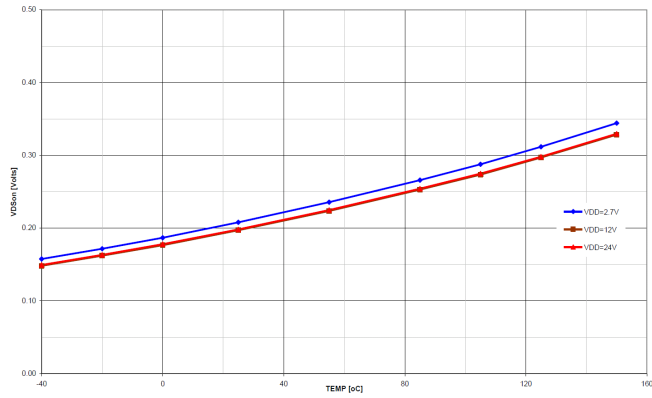

### 9.4 $V_{DSON}$ vs. $V_{DD}$

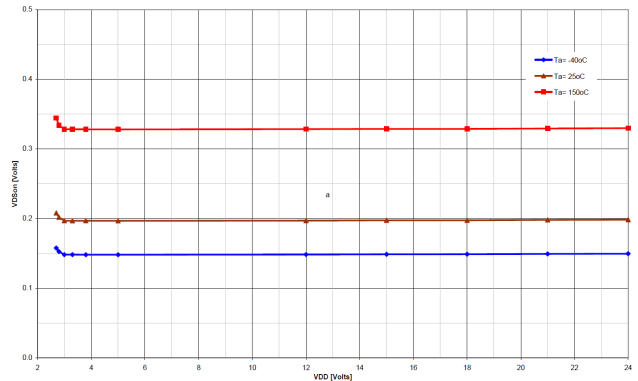

### 9.5 $I_{DD}$ vs. $T_A$

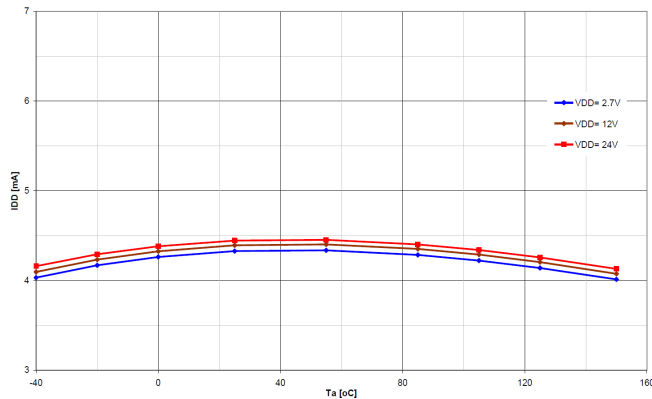

### 9.6 $I_{DD}$ vs. $V_{DD}$

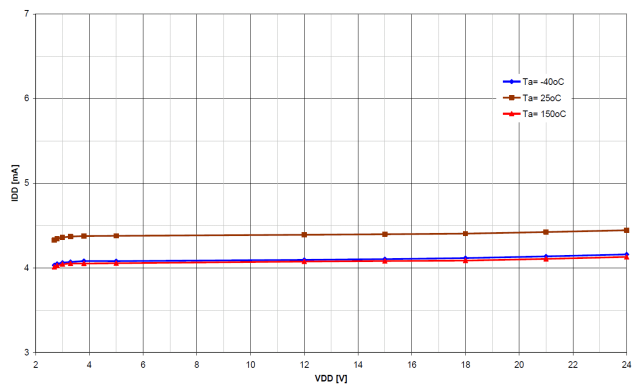

### 9.7 $I_{LEAK}$ vs. $T_A$

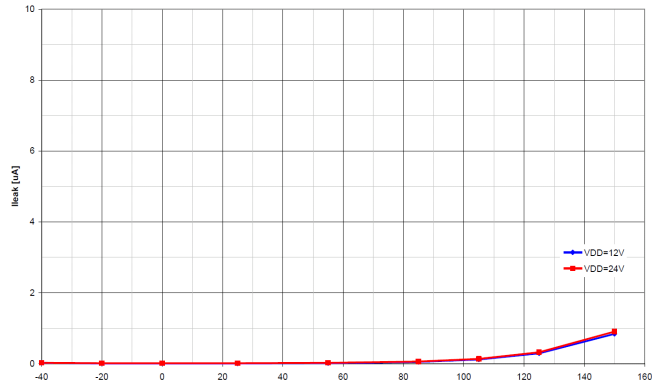

### 9.8 $I_{LEAK}$ vs. $V_{DD}$

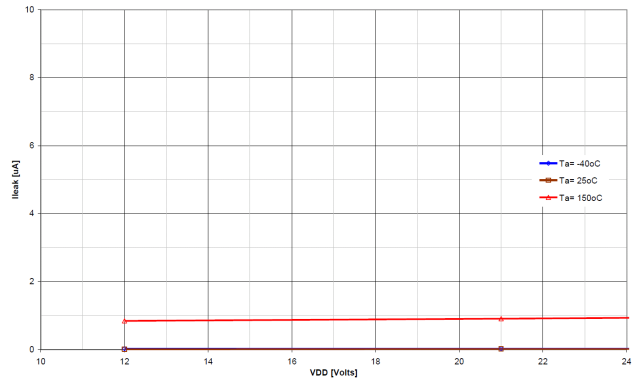

### 9.9 Power Derating vs. $T_A$

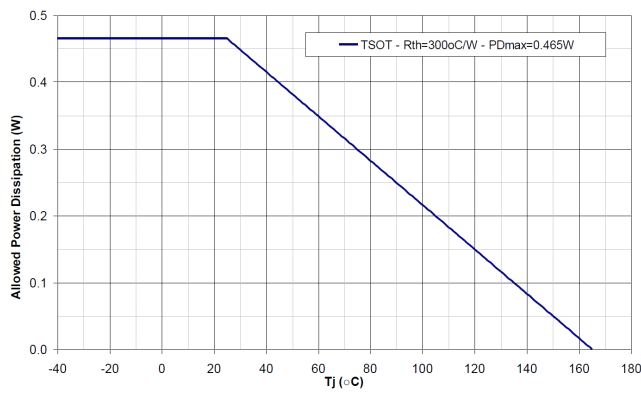

## **10 Standard information regarding manufacturability of Melexis products with different soldering processes**

Our products are classified and qualified regarding soldering technology, solderability and moisture sensitivity level according to following test methods:

### **Reflow Soldering SMD's (Surface Mount Devices)**

- IPC/JEDEC J-STD-020  
Moisture/Reflow Sensitivity Classification for Nonhermetic Solid State Surface Mount Devices (classification reflow profiles according to table 5-2)
- EIA/JEDEC JESD22-A113  
Preconditioning of Nonhermetic Surface Mount Devices Prior to Reliability Testing (reflow profiles according to table 2)

### **Wave Soldering SMD's (Surface Mount Devices) and THD's (Through Hole Devices)**

- EN60749-20  
Resistance of plastic- encapsulated SMD's to combined effect of moisture and soldering heat
- EIA/JEDEC JESD22-B106 and EN60749-15  
Resistance to soldering temperature for through-hole mounted devices

### **Iron Soldering THD's (Through Hole Devices)**

- EN60749-15  
Resistance to soldering temperature for through-hole mounted devices

### **Solderability SMD's (Surface Mount Devices) and THD's (Through Hole Devices)**

- EIA/JEDEC JESD22-B102 and EN60749-21  
Solderability

For all soldering technologies deviating from above mentioned standard conditions (regarding peak temperature, temperature gradient, temperature profile etc) additional classification and qualification tests have to be agreed upon with Melexis.

The application of Wave Soldering for SMD's is allowed only after consulting Melexis regarding assurance of adhesive strength between device and board.

Melexis recommends reviewing on our web site the General Guidelines [soldering recommendation](http://www.melexis.com/Quality_soldering.aspx) ([http://www.melexis.com/Quality\\_soldering.aspx](http://www.melexis.com/Quality_soldering.aspx)) as well as [trim&form recommendations](http://www.melexis.com/Assets/Trim-and-form-recommendations-5565.aspx) (<http://www.melexis.com/Assets/Trim-and-form-recommendations-5565.aspx>).

Melexis is contributing to global environmental conservation by promoting **lead free** solutions. For more information on qualifications of **RoHS** compliant products (RoHS = European directive on the Restriction Of the use of certain Hazardous Substances) please visit the quality page on our website: <http://www.melexis.com/quality.aspx>

## **11 ESD Precautions**

Electronic semiconductor products are sensitive to Electro Static Discharge (ESD). Always observe Electro Static Discharge control procedures whenever handling semiconductor products.

## 12 SE Package Information

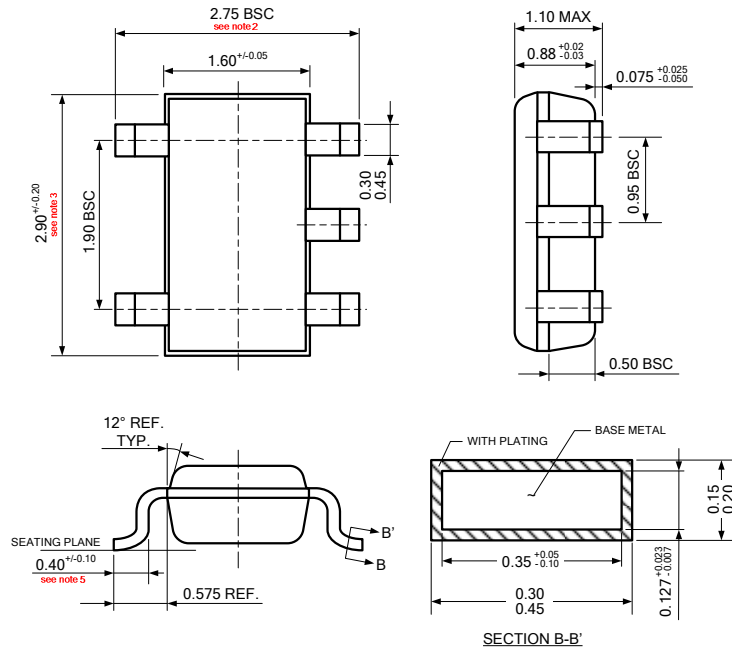

**Notes:**

- All dimensions are in millimeters
- Outermost plastic extreme width does not include mold flash or protrusions. Mold flash and protrusions shall not exceed 0.15mm per side.
- Outermost plastic extreme length does not include mold flash or protrusions. Mold flash and protrusions shall not exceed 0.25mm per side.
- The lead width dimension does not include dambar protrusion. Allowable dambar protrusion shall be 0.07mm total in excess of the lead width dimension at maximum material condition.
- Dimension is the length of terminal for soldering to a substrate.
- Formed lead shall be planar with respect to one another with 0.076mm at seating plane.
- This part is compliant with JEDEC specification MO-193. This part is full compliance to EIAJ specification SC-74.

**Marking:**

Top Side: •51A - Name of the Device (MLX92251AA)  
 Bottom Side: xyww x = last digit of lot number  
 y = last digit of year  
 ww = week

**Hall plate location**

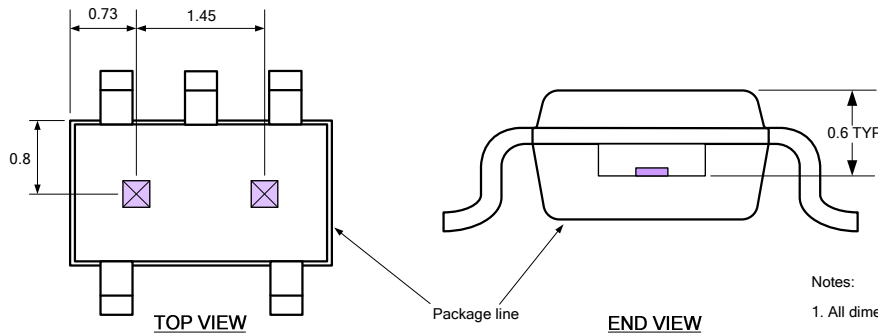

**Notes:**

- All dimensions are in millimeters

### 12.1 Pin Definitions and Descriptions

SE Pin №	Name	Type	Function
1	SP	Output	Speed Open-Drain Output
2	DIR	Output	Direction Open-Drain Output
3	VDD	Supply	Power Supply
4	GND	Ground	Ground pin
5	GND	Ground	Ground pin

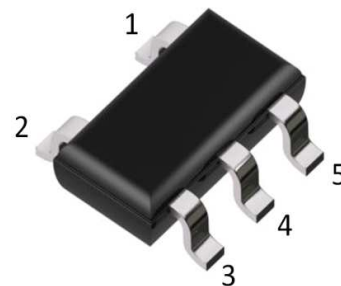



## 13 Disclaimer

Devices sold by Melexis are covered by the warranty and patent indemnification provisions appearing in its Term of Sale. Melexis makes no warranty, express, statutory, implied, or by description regarding the information set forth herein or regarding the freedom of the described devices from patent infringement. Melexis reserves the right to change specifications and prices at any time and without notice. Therefore, prior to designing this product into a system, it is necessary to check with Melexis for current information. This product is intended for use in normal commercial applications. Applications requiring extended temperature range, unusual environmental requirements, or high reliability applications, such as military, medical life-support or life-sustaining equipment are specifically not recommended without additional processing by Melexis for each application.

The information furnished by Melexis is believed to be correct and accurate. However, Melexis shall not be liable to recipient or any third party for any damages, including but not limited to personal injury, property damage, loss of profits, loss of use, interrupt of business or indirect, special incidental or consequential damages, of any kind, in connection with or arising out of the furnishing, performance or use of the technical data herein. No obligation or liability to recipient or any third party shall arise or flow out of Melexis' rendering of technical or other services.

© 2012 Melexis NV. All rights reserved.

For the latest version of this document, go to our website at  
**[www.melexis.com](http://www.melexis.com)**

Or for additional information contact Melexis Direct:

Europe, Africa:	Americas:	Asia:
Phone: +32 1367 0495	Phone: +1 248-306-5400	Phone: +32 1367 0495
E-mail: <a href="mailto:sales_europe@melexis.com">sales_europe@melexis.com</a>	E-mail: <a href="mailto:sales_usa@melexis.com">sales_usa@melexis.com</a>	E-mail: <a href="mailto:sales_asia@melexis.com">sales_asia@melexis.com</a>

ISO/TS 16949 and ISO14001 Certified