



Chipsmall Limited consists of a professional team with an average of over 10 year of expertise in the distribution of electronic components. Based in Hongkong, we have already established firm and mutual-benefit business relationships with customers from,Europe,America and south Asia,supplying obsolete and hard-to-find components to meet their specific needs.

With the principle of “Quality Parts,Customers Priority,Honest Operation,and Considerate Service”,our business mainly focus on the distribution of electronic components. Line cards we deal with include Microchip,ALPS,ROHM,Xilinx,Pulse,ON,Everlight and Freescale. Main products comprise IC,Modules,Potentiometer,IC Socket,Relay,Connector.Our parts cover such applications as commercial,industrial, and automotives areas.

We are looking forward to setting up business relationship with you and hope to provide you with the best service and solution. Let us make a better world for our industry!



Contact us

Tel: +86-755-8981 8866 Fax: +86-755-8427 6832

Email & Skype: info@chipsmall.com Web: www.chipsmall.com

Address: A1208, Overseas Decoration Building, #122 Zhenhua RD., Futian, Shenzhen, China



MM80C95 • MM80C97 • MM80C98

3-STATE Hex Buffers • 3-STATE Hex Inverters

General Description

The MM80C95, MM80C97 and MM80C98 gates are monolithic complementary MOS (CMOS) integrated circuits constructed with N- and P-channel enhancement mode transistors. The MM80C95 and the MM80C97 convert CMOS or TTL outputs to 3-STATE outputs with no logic inversion, the MM80C98 provides the logical opposite of the input signal. The MM80C95 has common 3-STATE controls for all six devices. The MM80C97 and the MM80C98 have two 3-STATE controls; one for two devices and one for the other four devices. Inputs are protected from damage due to static discharge by diode clamps to V_{CC} and GND.

Features

- Wide supply voltage range: 3.0V to 15V
- Guaranteed noise margin: 1.0V
- High noise immunity: 0.45 V_{CC} (typ.)
- TTL compatible: Drive 1 TTL Load

Applications

- Bus drivers: Typical propagation delay into 150 pF load is 40 ns

Ordering Code:

Order Number	Package Number	Package Description
MM80C95N	N16E	16-Lead Plastic Dual-In-Line Package (PDIP), JEDEC MS-001, 0.300" Wide
MM80C97M	M16A	16-Lead Small Outline Integrated Circuit (SOIC), JEDEC MS-012, 0.150" Narrow
MM80C97N	N16E	16-Lead Plastic Dual-In-Line Package (PDIP), JEDEC MS-001, 0.300" Wide
MM80C98N	N16E	16-Lead Plastic Dual-In-Line Package (PDIP), JEDEC MS-001, 0.300" Wide

Devices also available in Tape and Reel. Specify by appending the suffix letter "X" to the ordering code.

Connection Diagrams

Pin Assignments for DIP

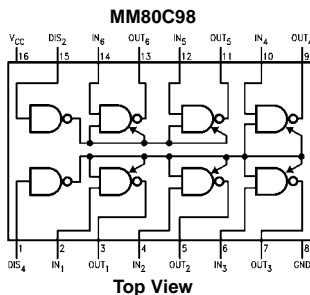
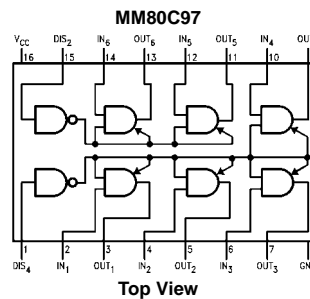
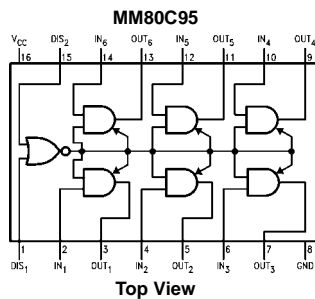

Schematic Diagrams

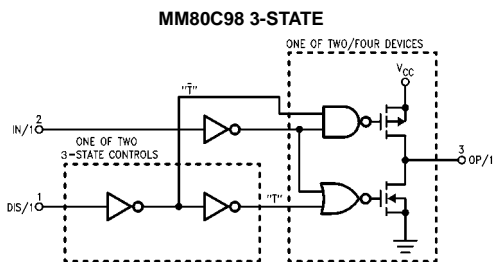
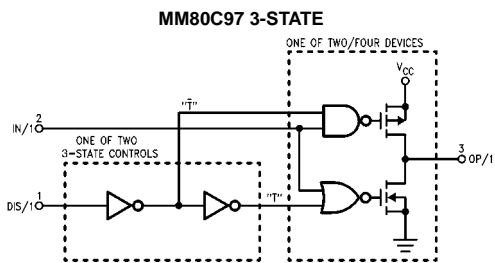
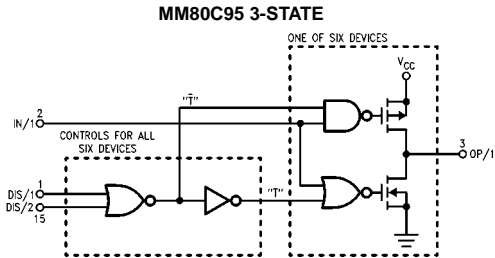

Truth Tables

MM80C95

Disable DIS ₁	Input DIS ₂	Input	Output
0	0	0	0
0	0	1	1
0	1	X	H-z
1	0	X	H-z
1	1	X	H-z

MM80C97

Disable DIS ₄	Input DIS ₂	Input	Output
0	0	0	0
0	0	1	1
X	1	X	H-z (Note 1)
1	X	X	H-z (Note 2)

MM80C98

Disable DIS ₄	Input DIS ₂	Input	Output
0	0	0	1
0	0	1	0
X	1	X	H-z (Note 1)
1	X	X	H-z (Note 2)

X = Irrelevant

Note 1: Output 5–6 only

Note 2: Output 1–4 only

Absolute Maximum Ratings (Note 3)		Power Supply Voltage (V_{CC})	18V
Voltage at Any Pin	-0.3V to $V_{CC} + 0.3V$	Lead Temperature (Soldering, 10 seconds)	260°C
Operating Temperature Range	-40°C to +85°C		
Storage Temperature Range	-65°C to +150°C		
Power Dissipation (P_D)			
Dual-In-Line	700 mW		
Small Outline	500 mW		

Note 3: "Absolute Maximum Ratings" are those values beyond which the safety of the device cannot be guaranteed. Except for "Operating Temperature Range" they are not meant to imply that the device should be operated at these limits. The table of "Electrical Characteristics" provides conditions for actual device operation.

DC Electrical Characteristics

Min/Max limits apply across temperature range unless otherwise noted

Symbol	Parameter	Conditions	Min	Typ	Max	Units
CMOS TO CMOS						
$V_{IN(1)}$	Logical "1" Input Voltage	$V_{CC} = 5V$ $V_{CC} = 10V$	3.5 8.0			V
$V_{IN(0)}$	Logical "0" Input Voltage	$V_{CC} = 5V$ $V_{CC} = 10V$			1.5 2.0	V
$V_{OUT(1)}$	Logical "1" Output Voltage	$V_{CC} = 5V$ $V_{CC} = 10V$	4.5 9.0			V
$V_{OUT(0)}$	Logical "0" Output Voltage	$V_{CC} = 5V$ $V_{CC} = 10V$			0.5 1.0	V
$I_{IN(1)}$	Logical "1" Input Current	$V_{CC} = 15V$		0.005	1.0	μA
$I_{IN(0)}$	Logical "0" Input Current		-1.0	-0.005		μA
I_{OZ}	Output Current in High Impedance State	$V_{CC} = 15V, V_O = 15V$ $V_{CC} = 15V, V_O = 0V$	-1.0	0.005	1.0	μA
I_{CC}	Supply Current	$V_{CC} = 15V$		0.01	15	μA
TTL INTERFACE						
$V_{IN(1)}$	Logical "1" Input Voltage	$V_{CC} = 4.75V$	$V_{CC} - 1.5$			V
$V_{IN(0)}$	Logical "0" Input Voltage	$V_{CC} = 4.75V$			0.8	V
$V_{OUT(1)}$	Logical "1" Output Voltage	$V_{CC} = 4.75V,$ $I_O = -1.6 \text{ mA}$	2.4			V
$V_{OUT(0)}$	Logical "0" Output Voltage	$V_{CC} = 4.75V,$ $I_O = 1.6 \text{ mA}$			0.4	V
OUTPUT DRIVE (Short Circuit Current)						
I_{SOURCE}	Output Source Current	$V_{CC} = 5V, V_{IN(1)} = 5V$ $T_A = 25^\circ C, V_{OUT} = 0V$	-4.35			mA
I_{SOURCE}	Output Source Current	$V_{CC} = 10V, V_{IN(1)} = 10V$ $T_A = 25^\circ C, V_{OUT} = 0V$	-20			mA
I_{SINK}	Output Sink Current	$V_{CC} = 5V, V_{IN(0)} = 0V$ $T_A = 25^\circ C, V_{OUT} = V_{CC}$	4.35			mA
I_{SINK}	Output Sink Current	$V_{CC} = 10V, V_{IN(0)} = 0V$ $T_A = 25^\circ C, V_{OUT} = V_{CC}$	20			mA

AC Electrical Characteristics (Note 4)						
T _A = 25°C, C _L = 50 pF, unless otherwise noted.						
Symbol	Parameter	Conditions	Min	Typ	Max	Units
t _{pd0} , t _{pd1}	Propagation Delay Time to a Logical "0" or Logical "1" from Data Input to Output MM80C95, MM80C97	V _{CC} = 5V		60	100	ns
		V _{CC} = 10V		25	40	ns
	MM80C98	V _{CC} = 5V		70	150	ns
		V _{CC} = 10V		35	75	ns
t _{pd0} , t _{pd1}	Propagation Delay Time to a Logical "0" or Logical "1" from Data Input to Output MM80C95, MM80C97	V _{CC} = 5V, C _L = 150 pF		85	160	ns
		V _{CC} = 10V, C _L = 150 pF		40	80	ns
	MM80C98	V _{CC} = 5V, C _L = 150 pF		95	210	ns
		V _{CC} = 10V, C _L = 150 pF		45	110	ns
t _{1H} , t _{0H}	Delay from Disable Input to High Impedance State, (from Logical "1" or Logical "0") MM80C95	R _L = 10k, C _L = 5 pF				
		V _{CC} = 5V		80	135	ns
	MM80C97	V _{CC} = 10V		50	90	ns
		V _{CC} = 5V		70	125	ns
	MM80C98	V _{CC} = 10V		50	90	ns
		V _{CC} = 5V		90	170	ns
		V _{CC} = 10V		70	125	ns
t _{1H} , t ₁₀	Delay from Disable Input to Logical "1" Level (from High Impedance State) MM80C95	R _L = 10k, C _L = 50 pF				
		V _{CC} = 5V		120	200	ns
	MM80C96	V _{CC} = 10V		50	90	ns
		V _{CC} = 5V		130	225	ns
	MM80C98	V _{CC} = 10V		60	110	ns
		V _{CC} = 5V		120	200	ns
		V _{CC} = 10V		50	90	ns
C _{IN}	Input Capacitance	Any Input (Note 5)		5.0		pF
C _{OUT}	Output Capacitance 3-STATE	Any Output (Note 5)		11		pF
C _{PD}	Power Dissipation Capacitance	(Note 6)		60		pF

Note 4: AC Parameters are guaranteed by DC correlated testing.

Note 5: Capacitance is guaranteed by periodic testing.

Note 6: C_{PD} determines the no load AC power consumption of any CMOS device. For complete explanation see Family Characteristics application note AN-90.

AC Test Circuits and Switching Time Waveforms

t_{pd0}, t_{pd1}

t_{1H} and t_{H1}

CMOS to CMOS

t_{1H}

AC Test Circuits and Switching Time Waveforms (Continued)

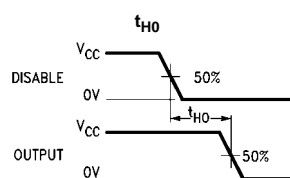
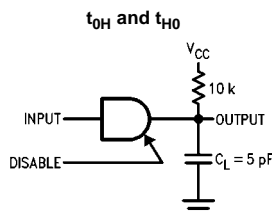
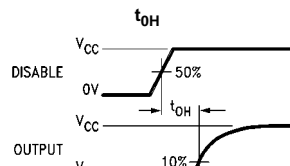
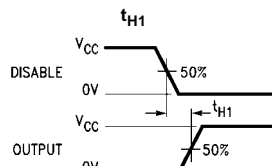

Note: Delays measured with input $t_r, t_f \leq 20$ ns.

Typical Performance Characteristics

Propagation Delay vs Load Capacitance

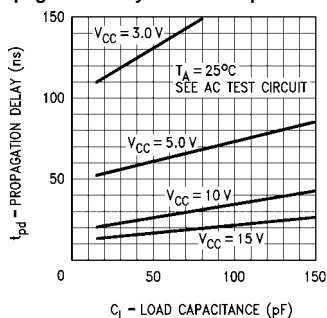

$\Delta t_{pd}/pF$ vs Power Supply Voltage

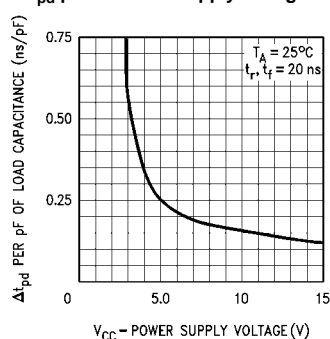

N-Channel Output Drive at 25°C

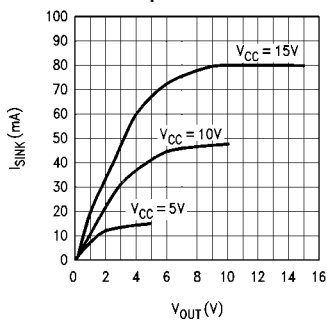

P-Channel Output Drive at 25°C

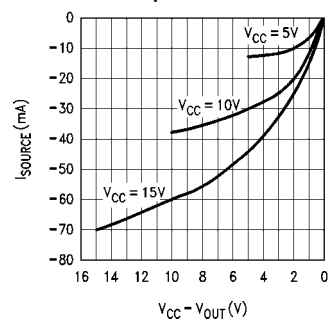

Physical Dimensions inches (millimeters) unless otherwise noted

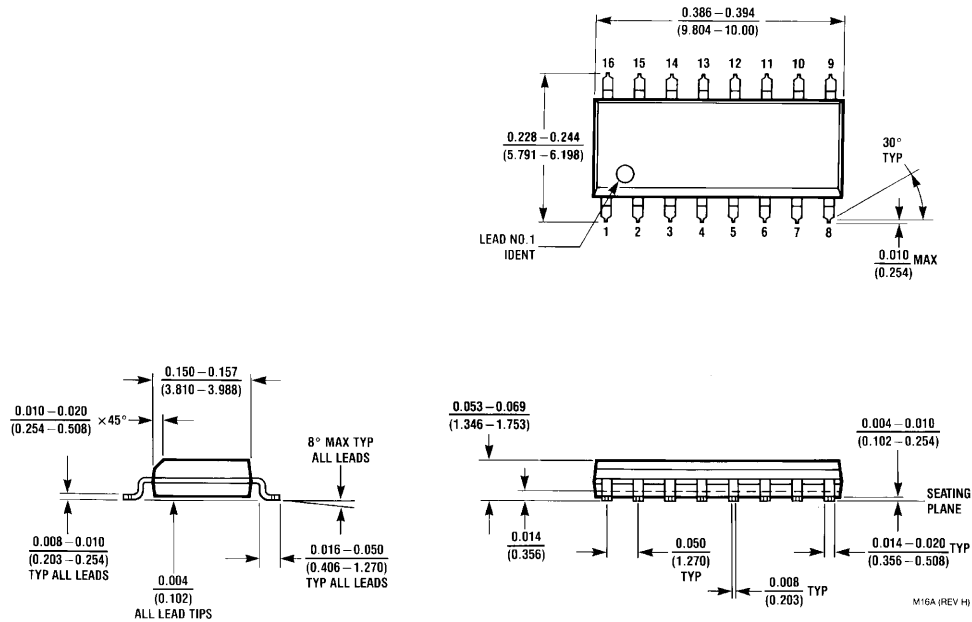

16-Lead Small Outline Integrated Circuit (SOIC), JEDEC MS-012, 0.150" Narrow Package Number M16A

Physical Dimensions inches (millimeters) unless otherwise noted (Continued)

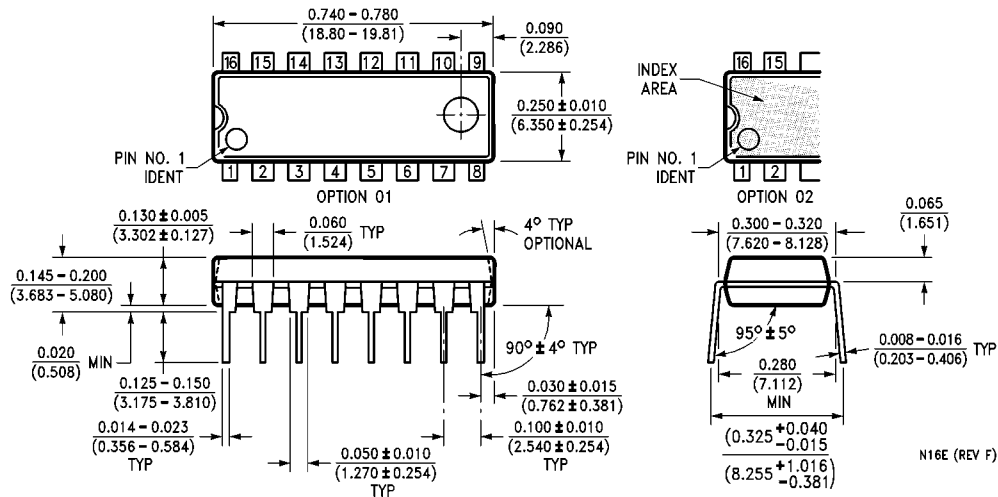

16-Lead Plastic Dual-In-Line Package (PDIP), JEDEC MS-001, 0.300" Wide Package Number N16E

LIFE SUPPORT POLICY

FAIRCHILD'S PRODUCTS ARE NOT AUTHORIZED FOR USE AS CRITICAL COMPONENTS IN LIFE SUPPORT DEVICES OR SYSTEMS WITHOUT THE EXPRESS WRITTEN APPROVAL OF THE PRESIDENT OF FAIRCHILD SEMICONDUCTOR CORPORATION. As used herein:

1. Life support devices or systems are devices or systems which, (a) are intended for surgical implant into the body, or (b) support or sustain life, and (c) whose failure to perform when properly used in accordance with instructions for use provided in the labeling, can be reasonably expected to result in a significant injury to the user.
2. A critical component in any component of a life support device or system whose failure to perform can be reasonably expected to cause the failure of the life support device or system, or to affect its safety or effectiveness.

www.fairchildsemi.com