



Chipsmall Limited consists of a professional team with an average of over 10 year of expertise in the distribution of electronic components. Based in Hongkong, we have already established firm and mutual-benefit business relationships with customers from,Europe,America and south Asia,supplying obsolete and hard-to-find components to meet their specific needs.

With the principle of "Quality Parts,Customers Priority,Honest Operation,and Considerate Service",our business mainly focus on the distribution of electronic components. Line cards we deal with include Microchip,ALPS,ROHM,Xilinx,Pulse,ON,Everlight and Freescale. Main products comprise IC,Modules,Potentiometer,IC Socket,Relay,Connector.Our parts cover such applications as commercial,industrial, and automotives areas.

We are looking forward to setting up business relationship with you and hope to provide you with the best service and solution. Let us make a better world for our industry!



Contact us

Tel: +86-755-8981 8866 Fax: +86-755-8427 6832

Email & Skype: info@chipsmall.com Web: www.chipsmall.com

Address: A1208, Overseas Decoration Building, #122 Zhenhua RD., Futian, Shenzhen, China



Features:

- Frequency Range: 28 - 31 GHz
- P3dB: +34 dBm
- IM3 Level: -35 dBc @Po=26dBm/tone
- Gain: 20 dB
- Vdd = 5 to 6V
- Idsq = 1200 to 3000mA
- Input and Output Fully Matched to 50 Ω
- Integrated Output Power Detector
- Surface Mount, RoHS Compliant QFN 5x5mm package

Applications:

- P2P Radio
- V-sat

Description:

The MMA-283134-M5 is a high power amplifier MMIC in a surface mount package designed for use in transmitters that operate at frequencies between 28GHz and 31GHz. In the operational frequency band, it provides 34dBm of output power (P3dB) and 20dB of small-signal gain. This MMIC is also optimized for high linearity applications. This MMIC provides IM3 level of -35dBc at Pout=26dBm/tone when biased under Vds=5V, Idsq=3000mA.

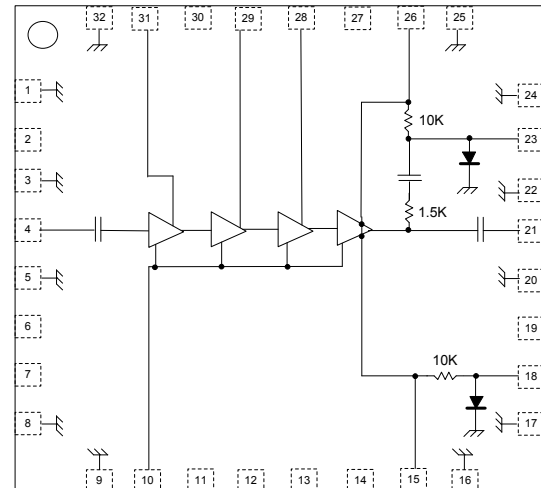

Functional Block Diagram

Absolute Maximum Ratings: (Ta= 25 °C)*

SYMBOL	PARAMETERS	UNITS	Min.	Max.
Vds	Drain-Source Voltage	V		6.5
Vg	Gate-Source Voltage	V	-2.1	0
Ig	First Gate Current	mA	-17	17
Pd	Power Dissipation	W		24
Pin max	RF Input Power	dBm		20
Toper	Operating Temperature	°C		-40 to +85
Tch	Channel Temperature	°C		+150
Tstg	Storage Temperature	°C		-55 to +150
Tmax	Max. Assembly Temp (20 sec max)	°C		+250

*Operation of this device above any one of these parameters may cause permanent damage.



MMA-283134-M5

28-31GHz 2.5W MMIC Power Amplifier Preliminary Data Sheet

Electrical Specifications: *V_{ds}=6V, V_{gs}=-0.85V, I_{dsq}=2000mA, T_a=25 °C Z₀=50 ohm*

Parameter	Units	Typical Data
Frequency Range	GHz	28-31
Gain (Typ)	dB	21
Gain Flatness (Typ/ Max)	+ / - dB	2.5/3
Input RL(Typ/ Max)	dB	10/8
Output RL(Typ/ Max)	dB	10/8
Output P1dB(Typ)	dBm	32
Output P3dB(Typ)	dBm	34
IM3 Level ⁽¹⁾	dBc	-40
Thermal Resistance	°C/W	3.8
Operating Current at P1dB(Typ/ Max)	mA	2500/3000

(1) Output IP3 is measured with two tones at output power of 20 dBm/tone separated by 20 MHz.

Typical RF Performance: $V_{ds}=6V, V_{gsq}=-0.85V, I_{dsq}=2000mA, Z_0=50\text{ ohm}, T_a=25\text{ }^\circ\text{C}$

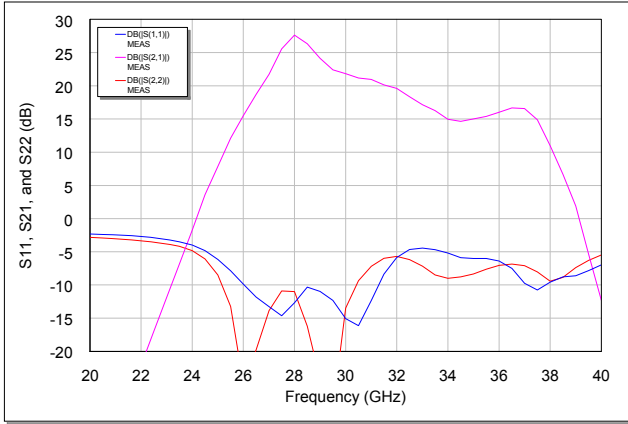

S11, S21, and S22 vs. Frequency

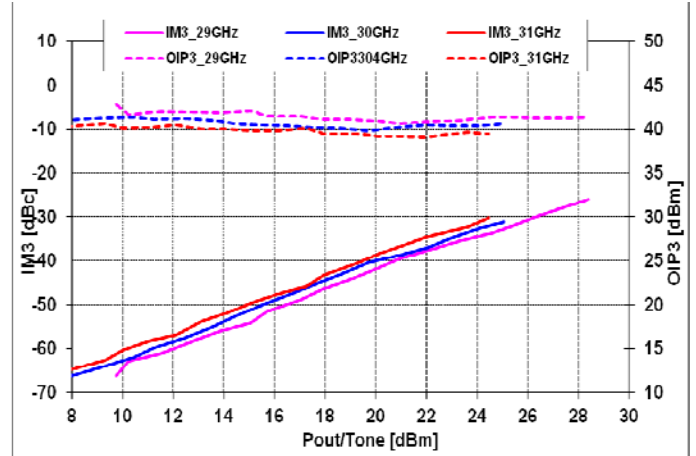

IM3 level [dBc] vs. Output power/tone [dBm]

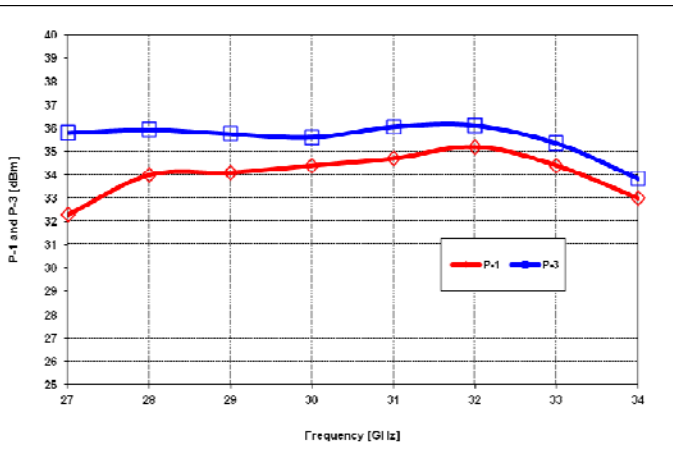

P-1 and P-3 vs. Frequency

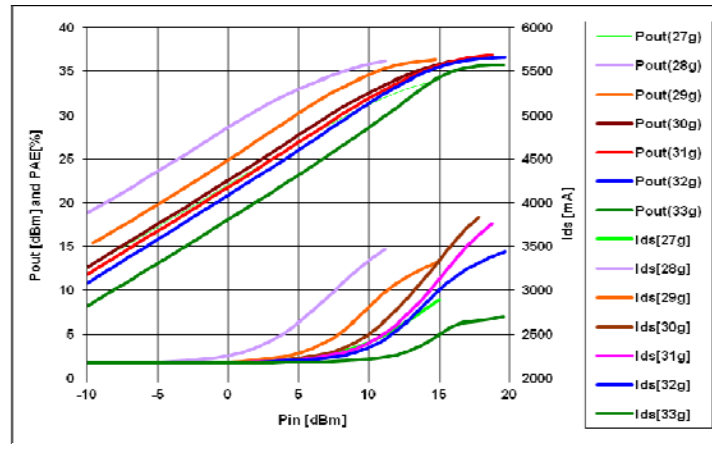

Po(dBm), and Ids(mA) vs. Pin(dBm)

Typical Bias dependent RF Performance: Vds=4V

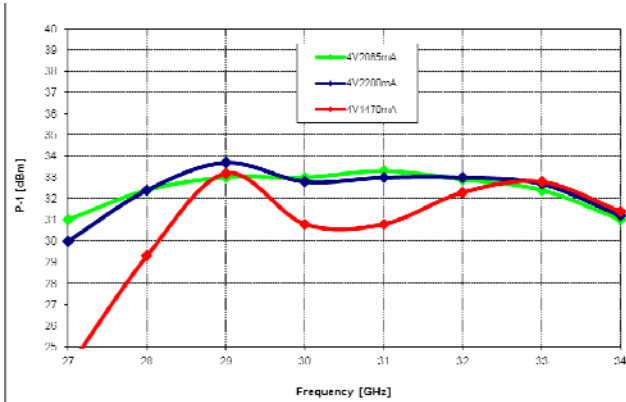

Bias dependent P-1 vs. Frequency

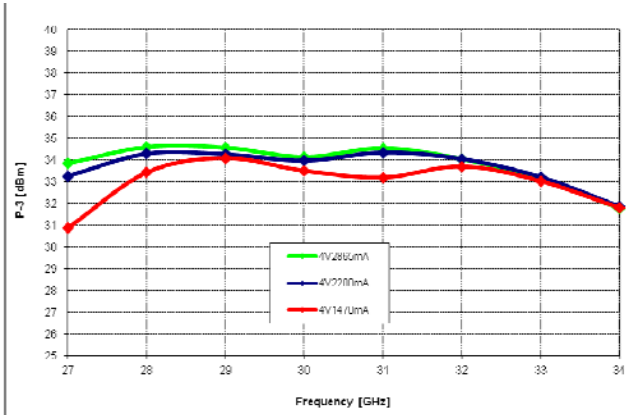

Bias dependent P-3 vs. Frequency

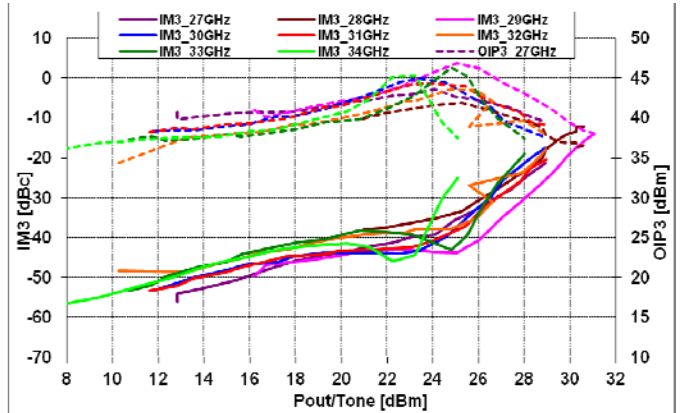

@Vds=4V, Idsq=2.8A

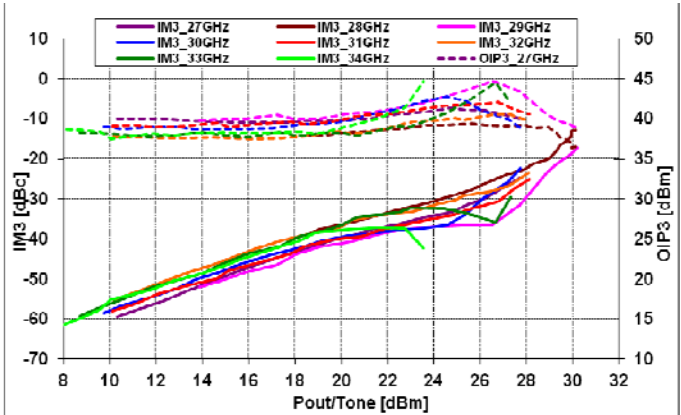

@Vds=4V, Idsq=2.2A

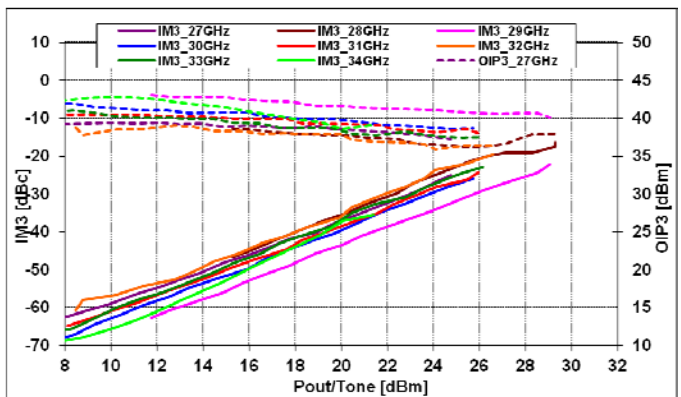

@Vds=4V, Idsq=2.2A

Typical Bias dependent RF Performance: $V_{ds}=5V$

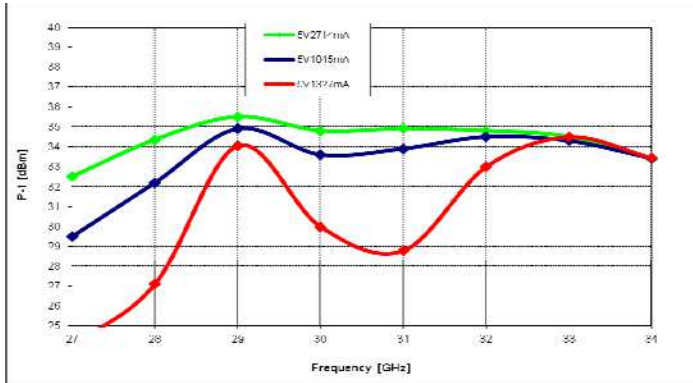

Bias dependent P1 vs. Frequency

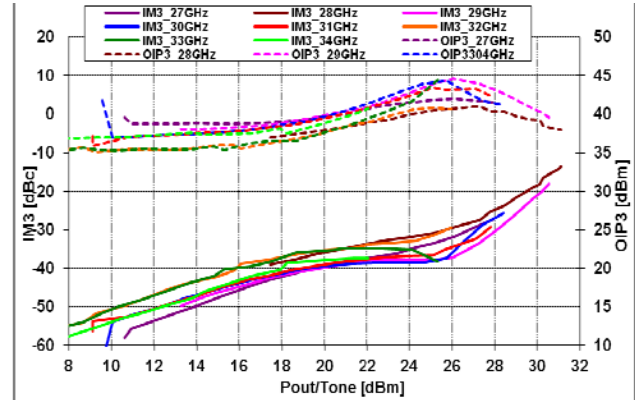

@ $V_{ds}=5V$, $I_{dsq}=3A$

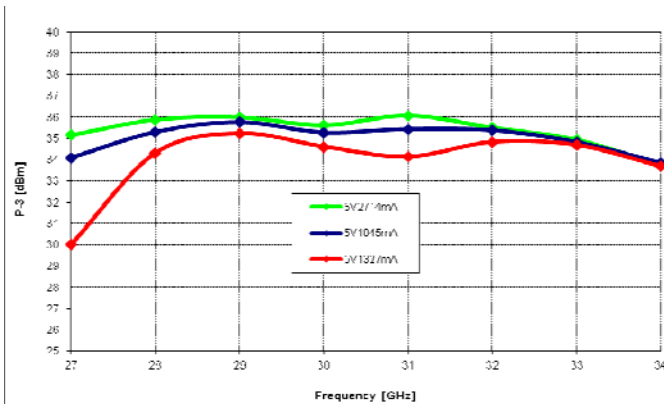

Bias dependent P-3 vs. Frequency

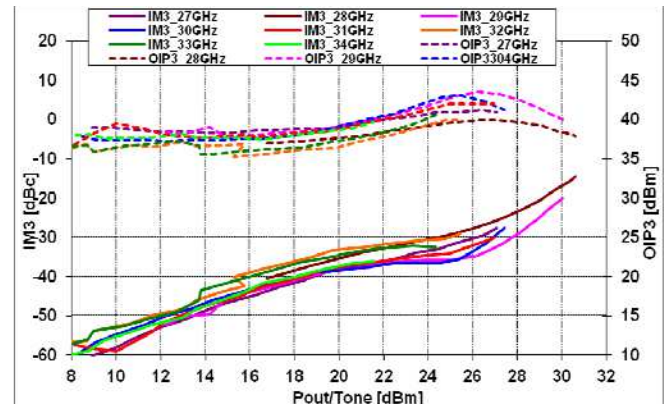

@ $V_{ds}=5V$, $I_{dsq}=2.6A$

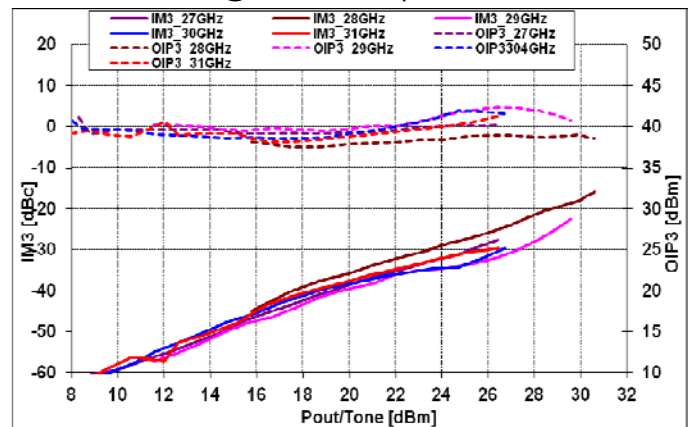

@ $V_{ds}=5V$, $I_{dsq}=1.5A$

Typical Bias dependent RF Performance: Vds=6V

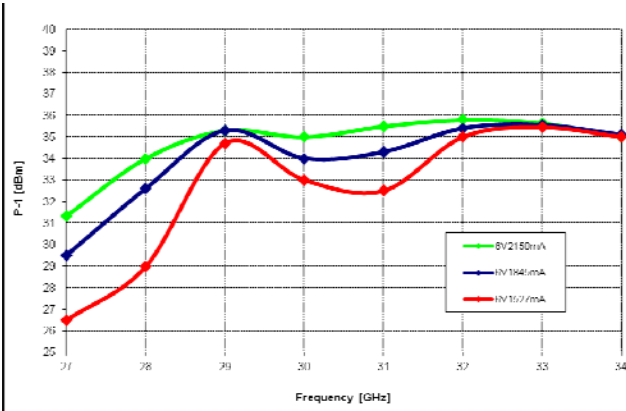

Bias dependent P1 vs. Frequency

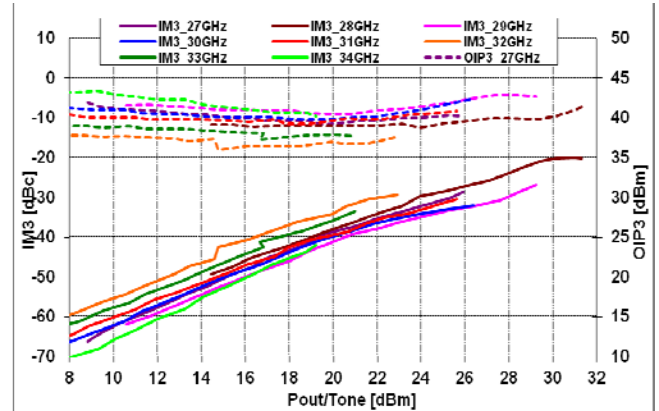

@Vds=6V, Idsq=2.5A

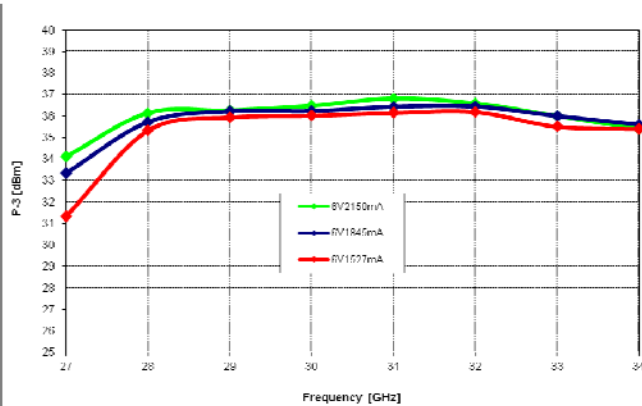

Bias dependent P-3 vs. Frequency

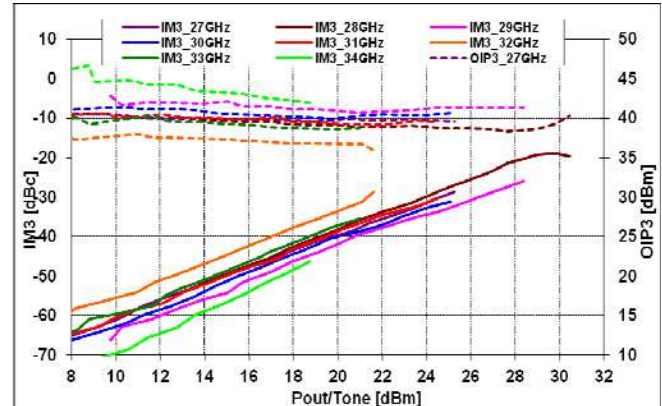

@Vds=6V, Idsq=2A

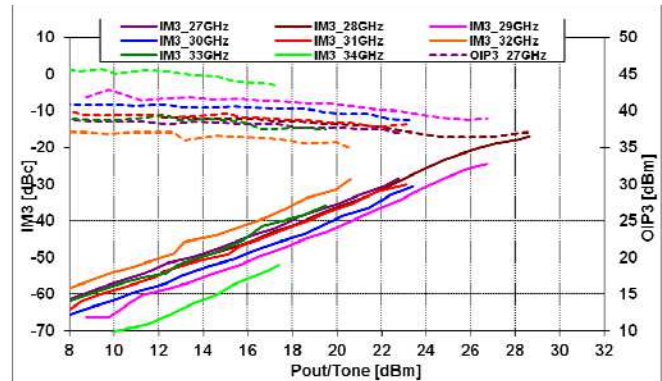

@Vds=6V, Idsq=1.5A

Typical Over Temperature Performance: $V_{ds}=6V, I_{ds}=2000mA, Z_0=50\text{ ohm}, T_a=-40, 25, \text{ and } 85\text{ }^\circ\text{C}$

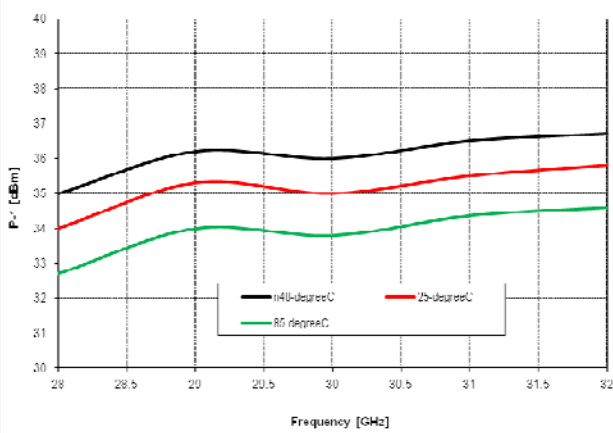

P1 over temperature

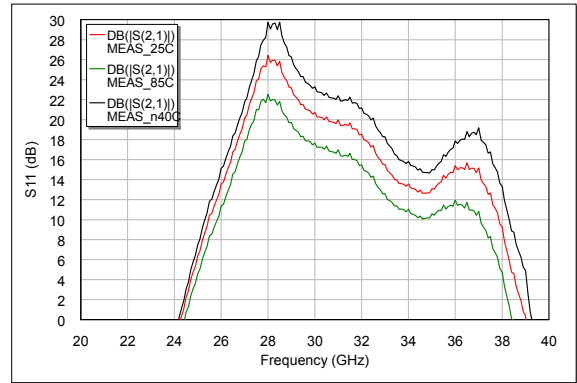

S21(dB)

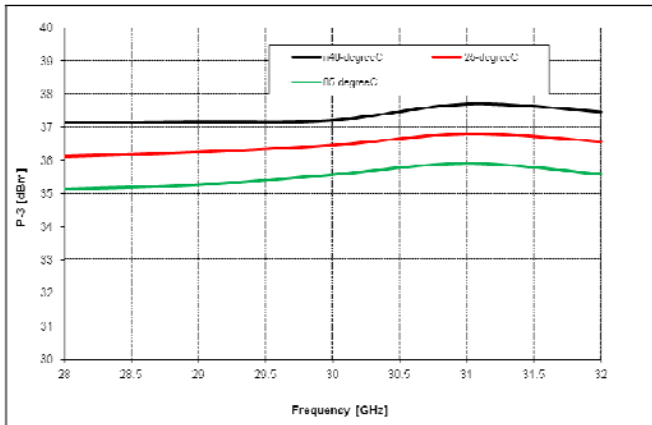

P-3 over temperature

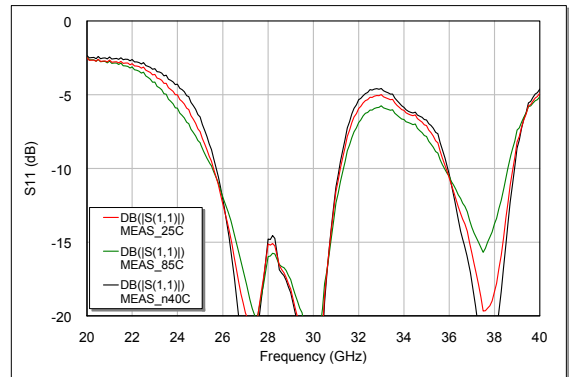

S11(dB)

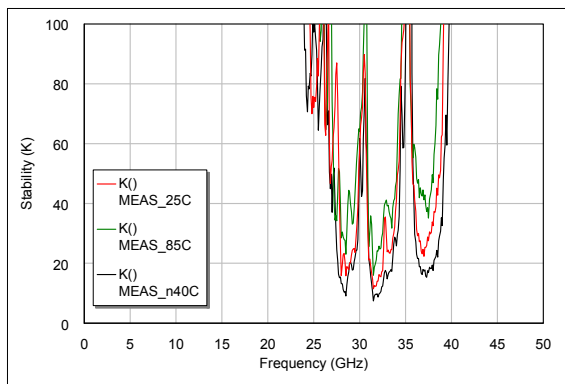

K-factor vs. Frequency

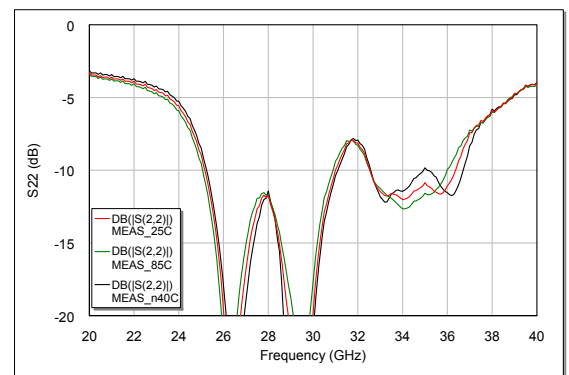

S22(dB)



MMA-283134-M5

28-31GHz 2.5W MMIC Power Amplifier Preliminary Data Sheet

Applications

The **MMA-283134-M5** MMIC power amplifier is designed for use as a power stage amplifier in microwave transmitters. It is ideally suited for 28 to 31GHz band V-sat transmitter applications requiring excellent saturated output power and linearity performance. This amplifier is provided as a 5x5mm QFN package, and the packaged amplifier is fully compatible with industry standard high volume surface mount PCB assembly processes.

Biassing and Operation

The recommended bias conditions for best performance for high power applications the **MMA-283134-M5** are $V_{DD} = 6.0V$, $I_{dsq} = 2000mA$. Performance improvements are possible depending on applications. For high linearity requirement at higher output power up to 27dBm/tone, recommended bias conditions are $V_{dd}=5V$, $I_{dsq}=3000mA$. The drain bias voltage range is 5 to 6V and the quiescent drain current biasing range is 1200mA to 3000mA. A single DC gate supply connected to V_g will bias all the amplifier stages. Muting can be accomplished by setting V_g to the pinch-off voltage ($V_p=-1.8V$). The gate voltage (V_g) should be applied prior to the drain voltages (V_{d1} , V_{d2} , V_{d3} , and V_{d4}) during power up and removed after the drain voltages during power down. The RF input and output ports are DC decoupled internally. Typical DC supply connection with bi-passing capacitors for the **MMA-283134-M5** is shown in following pages.

Assembly Techniques

GaAs MMICs are ESD sensitive. ESD preventive measures must be employed in all aspects of storage, handling, and assembly. MMIC ESD precautions, handling considerations, die attach and bonding methods are critical factors in successful GaAs MMIC performance and reliability.

Package Pin-out:

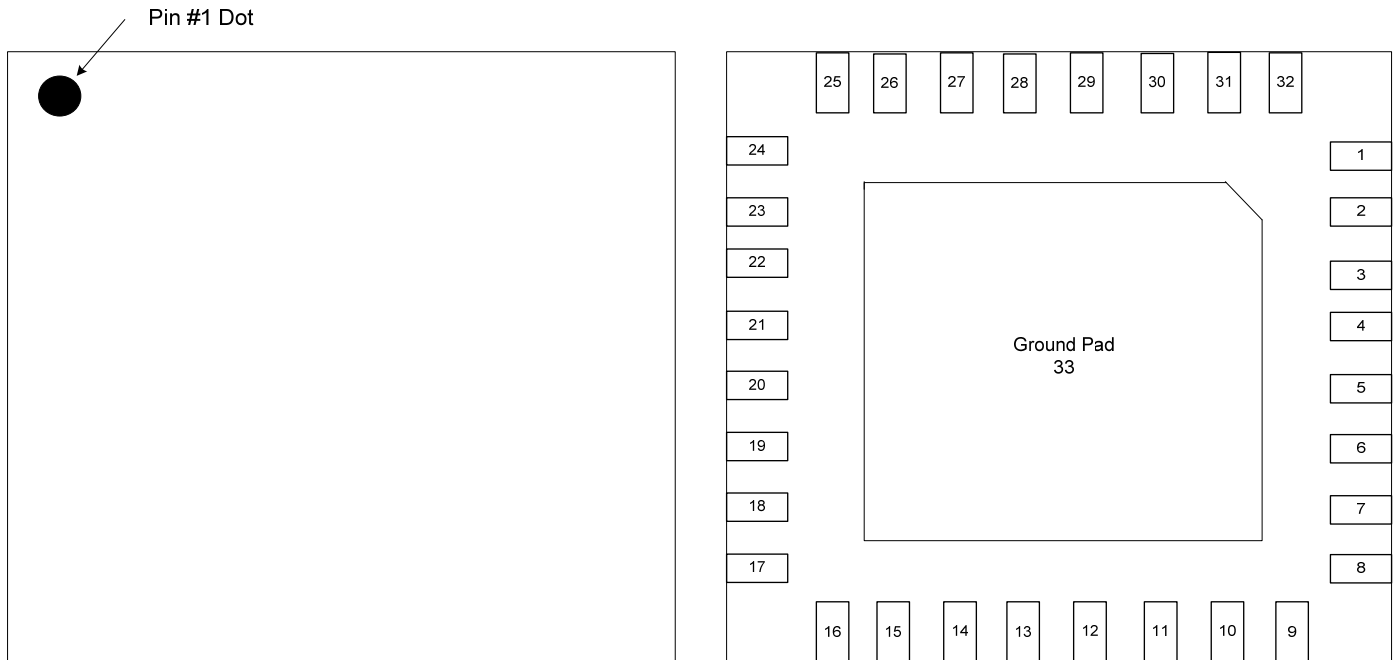

Pin	Description
4	RF Input
21	RF Output
10	Vg
31	Vd1
29	Vd2
28	Vd3
15, 26	Vd4
18	DET_Reference
23	DET_Output
1, 3, 5, 8, 9, 16, 17, 20, 22, 24, 25, 32, 33	Ground
2, 6, 7, 11, 12, 13, 14, 19, 27, 30	N/C

Mechanical Information:

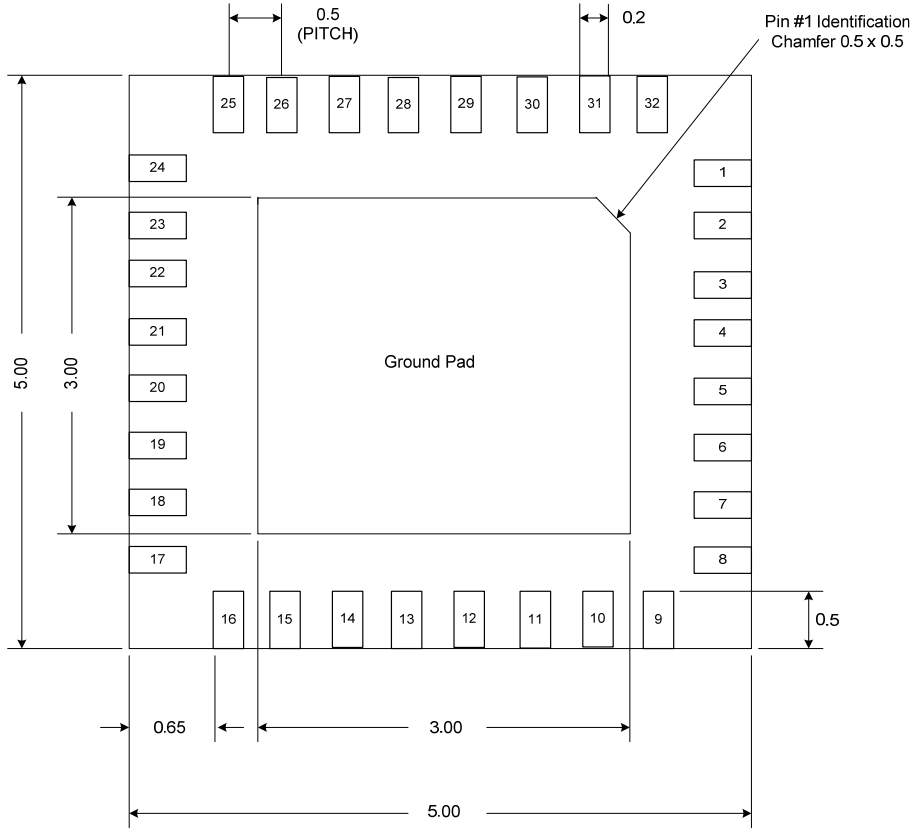

BOTTOM VIEW

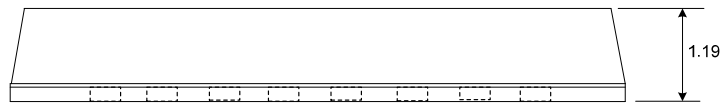

SIDE VIEW

The units are in [mm].

Application Circuit:

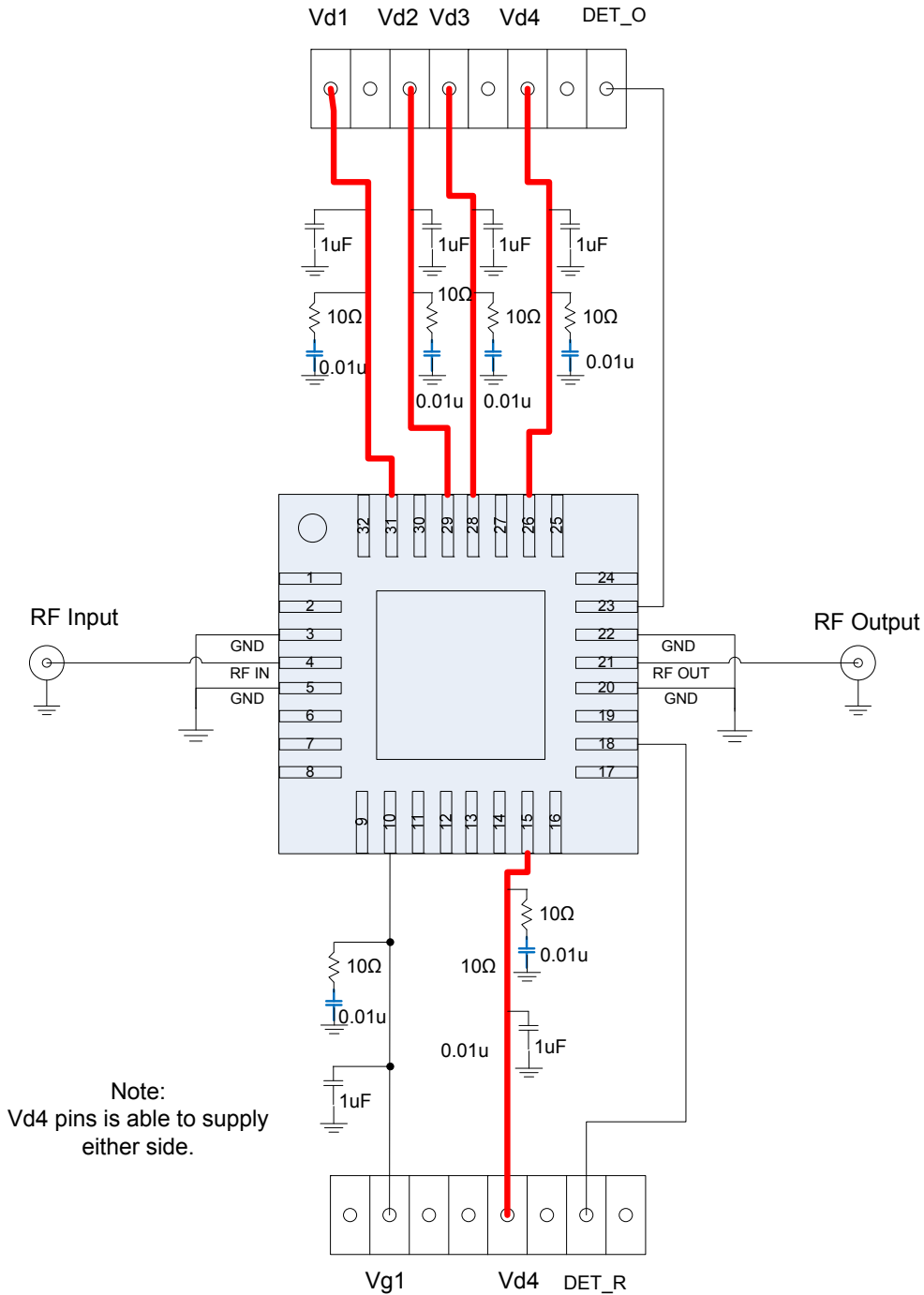

Recommended Application Board Design:

Board Material is 10mil (Dielectric) thickness Rogers 4350B with 0.5oz copper clads.

Board is soldered on a gold plated solid copper block and adequate heat-sinking is required for 16.8W total power dissipation.

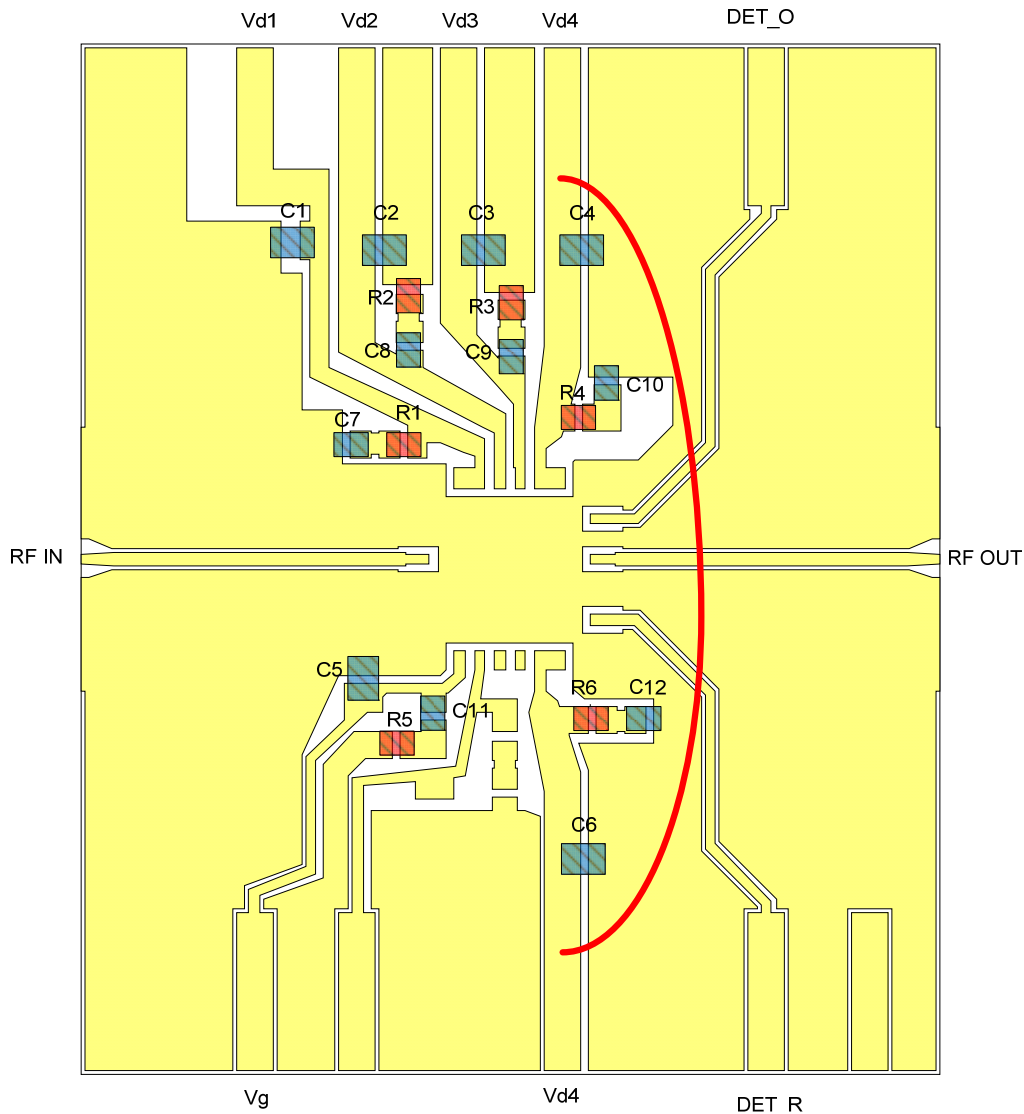

Part	Description
C1, C2, C3, C4, C5, C6	1uF capacitor (0603)
C7, C8, C9, C10, C11, C12	0.01uF Capacitor (0402)
R1, R2, R3, R4, R5, R6	10Ω Resistor (0402)

Recommended Application Board Design:

Board Material is 10mil (Dielectric) thickness Rogers 4350B with 0.5oz copper clads. The board material and mounting pattern, as defined in the data sheet, optimizes RF performance and is strongly recommended. An electronic drawing of the land pattern is available upon request from MwT Sales & Application Engineering.

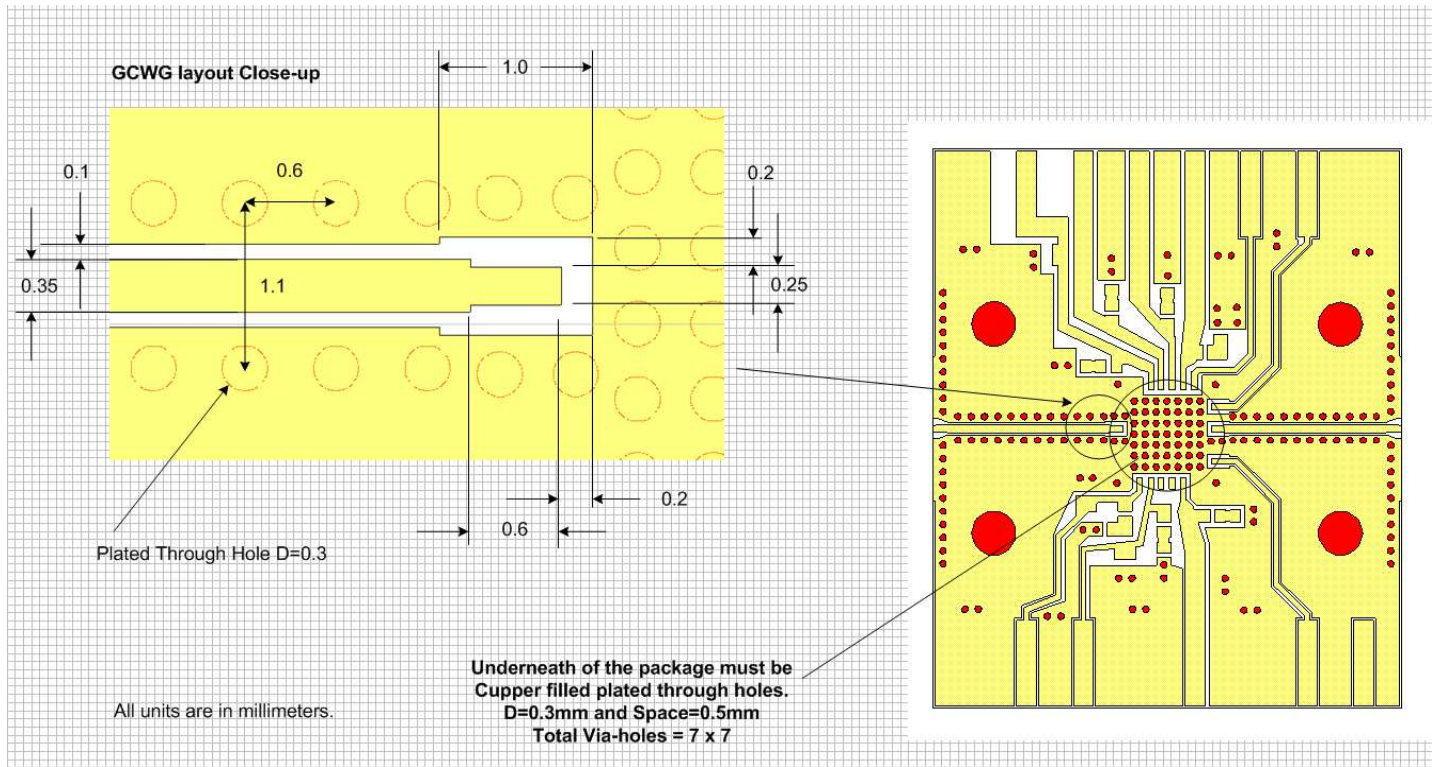

Copper filled thru vias
D=0.3mm, Space=0.5mm
7x7

For best thermal
dissipation, 3mm square
Copper filled PCB is
recommended.

