



Chipsmall Limited consists of a professional team with an average of over 10 year of expertise in the distribution of electronic components. Based in Hongkong, we have already established firm and mutual-benefit business relationships with customers from,Europe,America and south Asia,supplying obsolete and hard-to-find components to meet their specific needs.

With the principle of "Quality Parts,Customers Priority,Honest Operation,and Considerate Service",our business mainly focus on the distribution of electronic components. Line cards we deal with include Microchip,ALPS,ROHM,Xilinx,Pulse,ON,Everlight and Freescale. Main products comprise IC,Modules,Potentiometer,IC Socket,Relay,Connector.Our parts cover such applications as commercial,industrial, and automotives areas.

We are looking forward to setting up business relationship with you and hope to provide you with the best service and solution. Let us make a better world for our industry!



## Contact us

Tel: +86-755-8981 8866 Fax: +86-755-8427 6832

Email & Skype: info@chipsmall.com Web: www.chipsmall.com

Address: A1208, Overseas Decoration Building, #122 Zhenhua RD., Futian, Shenzhen, China



# MMBT5550L, MMBT5551L

## High Voltage Transistors

### NPN Silicon



ON Semiconductor®

[www.onsemi.com](http://www.onsemi.com)

#### Features

- S Prefix for Automotive and Other Applications Requiring Unique Site and Control Change Requirements; AEC-Q101 Qualified and PPAP Capable
- These Devices are Pb-Free, Halogen Free/BFR Free and are RoHS Compliant

#### MAXIMUM RATINGS

Rating	Symbol	Value	Unit
Collector - Emitter Voltage MMBT5550 MMBT5551	$V_{CEO}$	140 160	Vdc
Collector - Base Voltage MMBT5550 MMBT5551	$V_{CBO}$	160 180	Vdc
Emitter - Base Voltage	$V_{EBO}$	6.0	Vdc
Collector Current - Continuous	$I_C$	600	mAdc
Electrostatic Discharge Human Body Model Machine Model	ESD	> 8000 > 400	V

#### THERMAL CHARACTERISTICS

Characteristic	Symbol	Max	Unit
Total Device Dissipation FR-5 Board (Note 1) @ $T_A = 25^\circ\text{C}$ Derate Above $25^\circ\text{C}$	$P_D$	225 1.8	mW mW/ $^\circ\text{C}$
Thermal Resistance, Junction-to-Ambient	$R_{\theta JA}$	556	$^\circ\text{C}/\text{W}$
Total Device Dissipation Alumina Substrate (Note 2) @ $T_A = 25^\circ\text{C}$ Derate Above $25^\circ\text{C}$	$P_D$	300 2.4	mW mW/ $^\circ\text{C}$
Thermal Resistance, Junction-to-Ambient	$R_{\theta JA}$	417	$^\circ\text{C}/\text{W}$
Junction and Storage Temperature	$T_J, T_{stg}$	-55 to +150	$^\circ\text{C}$

Stresses exceeding those listed in the Maximum Ratings table may damage the device. If any of these limits are exceeded, device functionality should not be assumed, damage may occur and reliability may be affected.

1. FR-5 =  $1.0 \times 0.75 \times 0.062$  in.
2. Alumina =  $0.4 \times 0.3 \times 0.024$  in. 99.5% alumina.

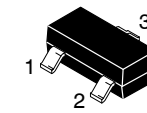
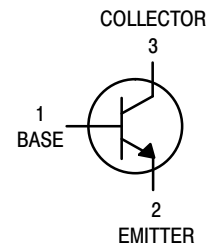

SOT-23 (TO-236)  
CASE 318  
STYLE 6

#### MARKING DIAGRAM

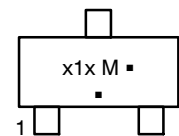

x1x = Device Code  
M1F = MMBT5550LT  
G1 = MMBT5551LT

M = Date Code\*  
■ = Pb-Free Package

(Note: Microdot may be in either location)  
\*Date Code orientation and/or overbar may vary depending upon manufacturing location.

#### ORDERING INFORMATION

Device	Package	Shipping†
MMBT5550LT1G	SOT-23 (Pb-Free)	3,000 / Tape & Reel
MMBT5550LT3G	SOT-23 (Pb-Free)	10,000 / Tape & Reel
MMBT5551LT1G	SOT-23 (Pb-Free)	3,000 / Tape & Reel
SMMBT5551LT1G	SOT-23 (Pb-Free)	3,000 / Tape & Reel
MMBT5551LT3G	SOT-23 (Pb-Free)	10,000 / Tape & Reel
SMMBT5551LT3G	SOT-23 (Pb-Free)	10,000 / Tape & Reel

†For information on tape and reel specifications, including part orientation and tape sizes, please refer to our Tape and Reel Packaging Specifications Brochure, BRD8011/D.

# MMBT5550L, MMBT5551L

## ELECTRICAL CHARACTERISTICS (T<sub>A</sub> = 25°C unless otherwise noted)

Characteristic		Symbol	Min	Max	Unit
<b>OFF CHARACTERISTICS</b>					
Collector – Emitter Breakdown Voltage (Note 3) (I <sub>C</sub> = 1.0 mAdc, I <sub>B</sub> = 0)	MMBT5550 MMBT5551	V <sub>(BR)CEO</sub>	140 160	– –	Vdc
Collector – Base Breakdown Voltage (I <sub>C</sub> = 100 μAdc, I <sub>E</sub> = 0)	MMBT5550 MMBT5551	V <sub>(BR)CBO</sub>	160 180	– –	Vdc
Emitter – Base Breakdown Voltage (I <sub>E</sub> = 10 μAdc, I <sub>C</sub> = 0)		V <sub>(BR)EBO</sub>	6.0	–	Vdc
Collector Cutoff Current (V <sub>CB</sub> = 100 Vdc, I <sub>E</sub> = 0) (V <sub>CB</sub> = 120 Vdc, I <sub>E</sub> = 0) (V <sub>CB</sub> = 100 Vdc, I <sub>E</sub> = 0, T <sub>A</sub> = 100°C) (V <sub>CB</sub> = 120 Vdc, I <sub>E</sub> = 0, T <sub>A</sub> = 100°C)	MMBT5550 MMBT5551 MMBT5550 MMBT5551	I <sub>CBO</sub>	– – – –	100 50 100 50	nAdc μAdc
Emitter Cutoff Current (V <sub>EB</sub> = 4.0 Vdc, I <sub>C</sub> = 0)		I <sub>EBO</sub>	–	50	nAdc
<b>ON CHARACTERISTICS</b>					
DC Current Gain (I <sub>C</sub> = 1.0 mAdc, V <sub>CE</sub> = 5.0 Vdc)  (I <sub>C</sub> = 10 mAdc, V <sub>CE</sub> = 5.0 Vdc)  (I <sub>C</sub> = 50 mAdc, V <sub>CE</sub> = 5.0 Vdc)	MMBT5550 MMBT5551 MMBT5550 MMBT5551 MMBT5550 MMBT5551	h <sub>FE</sub>	60 80 60 80 20 30	– – 250 250 – –	–
Collector – Emitter Saturation Voltage (I <sub>C</sub> = 10 mAdc, I <sub>B</sub> = 1.0 mAdc) (I <sub>C</sub> = 50 mAdc, I <sub>B</sub> = 5.0 mAdc)	Both Types MMBT5550 MMBT5551	V <sub>CE(sat)</sub>	– – –	0.15 0.25 0.20	Vdc
Base – Emitter Saturation Voltage (I <sub>C</sub> = 10 mAdc, I <sub>B</sub> = 1.0 mAdc) (I <sub>C</sub> = 50 mAdc, I <sub>B</sub> = 5.0 mAdc)	Both Types MMBT5550 MMBT5551	V <sub>BE(sat)</sub>	– – –	1.0 1.2 1.0	Vdc
Collector Emitter Cut-off (V <sub>CB</sub> = 10 V) (V <sub>CB</sub> = 75 V)	Both Types	I <sub>CES</sub>	– –	50 100	nA

Product parametric performance is indicated in the Electrical Characteristics for the listed test conditions, unless otherwise noted. Product performance may not be indicated by the Electrical Characteristics if operated under different conditions.

3. Pulse Test: Pulse Width = 300 μs, Duty Cycle = 2.0%.

# MMBT5550L, MMBT5551L

## TYPICAL CHARACTERISTICS

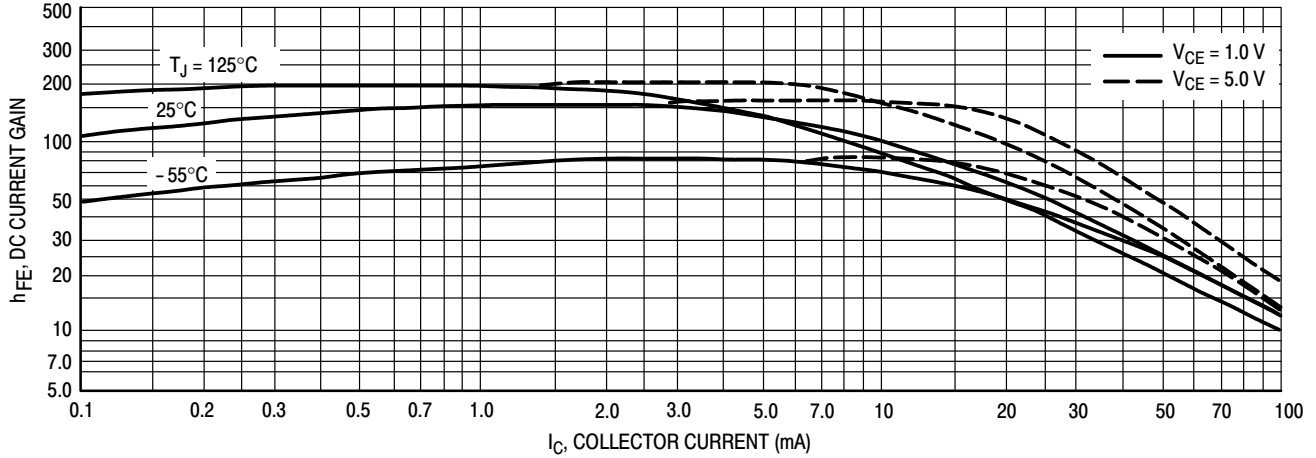

Figure 1. DC Current Gain

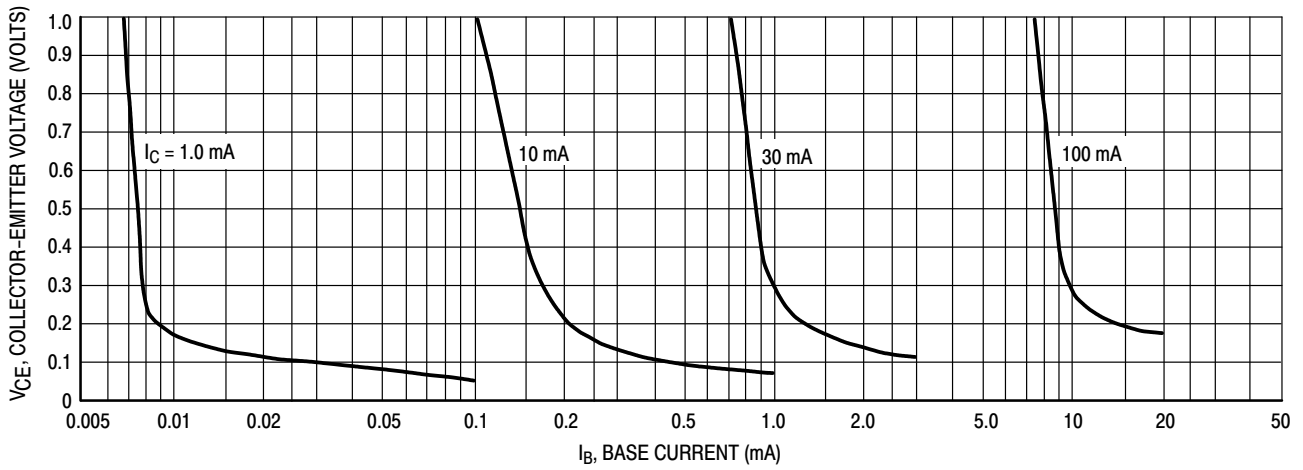

Figure 2. Collector Saturation Region

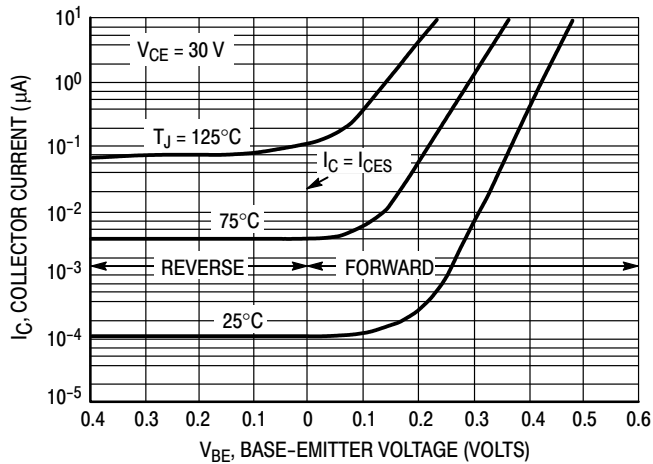

Figure 3. Collector Cut-Off Region

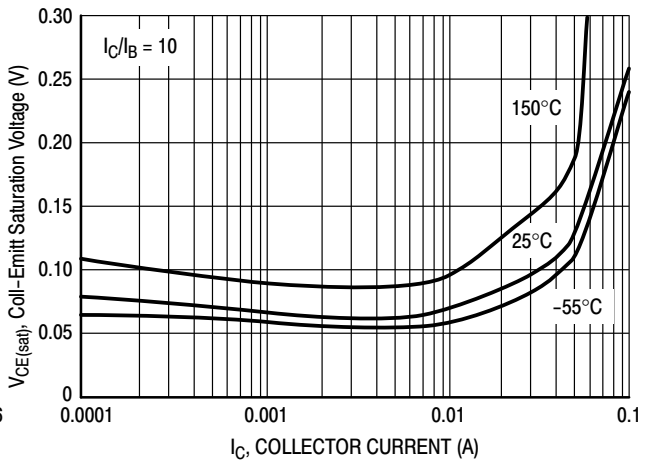

Figure 4.  $V_{CE(sat)}$

# MMBT5550L, MMBT5551L

## TYPICAL CHARACTERISTICS

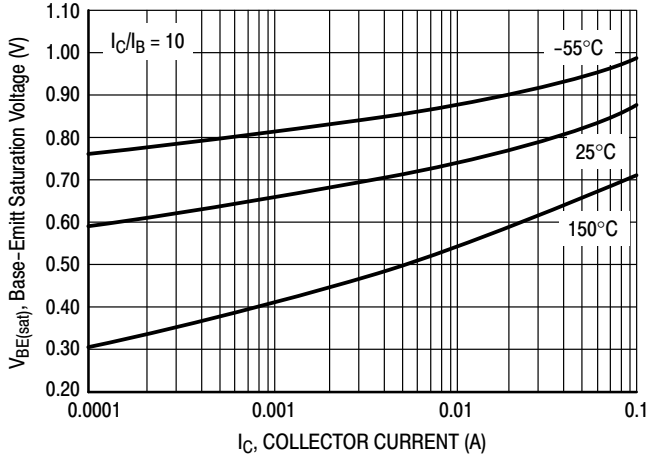

Figure 5.  $V_{BE(sat)}$

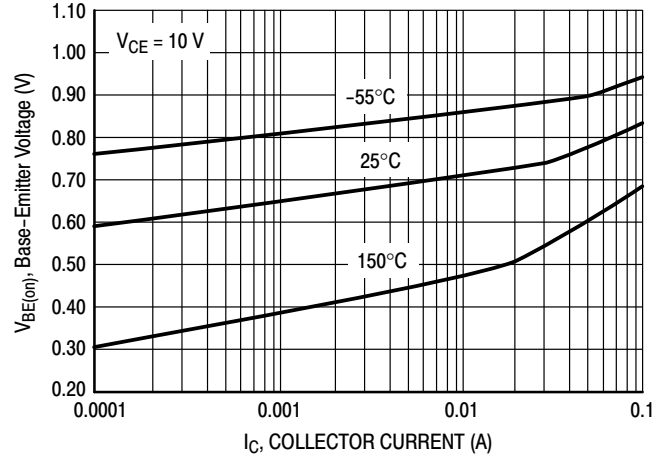

Figure 6.  $V_{BE(on)}$

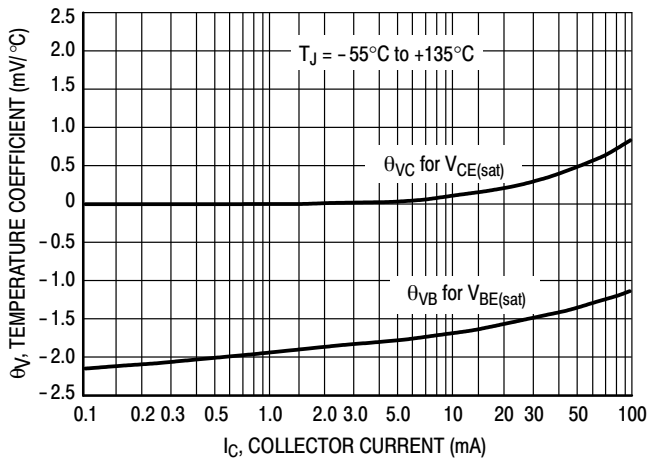

Figure 7. Temperature Coefficients

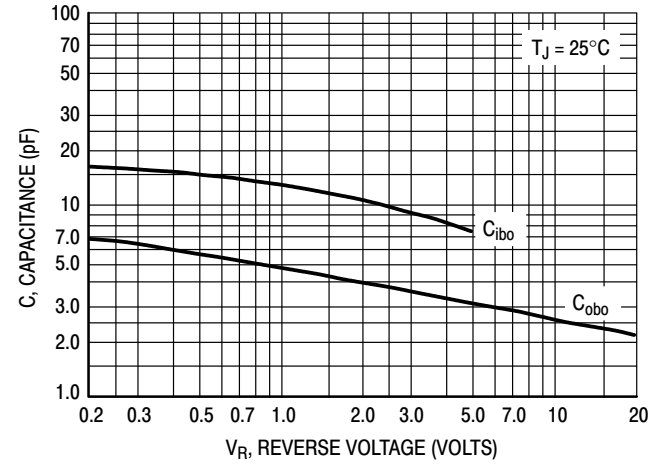
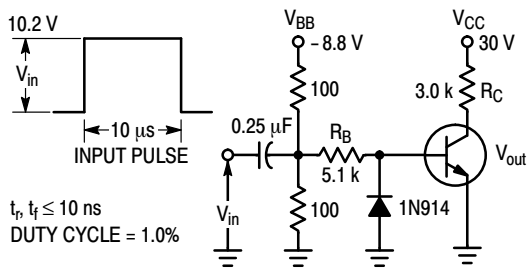

Figure 8. Capacitances



Values Shown are for  $I_C @ 10 \text{ mA}$

Figure 9. Switching Time Test Circuit

# MMBT5550L, MMBT5551L

## TYPICAL CHARACTERISTICS

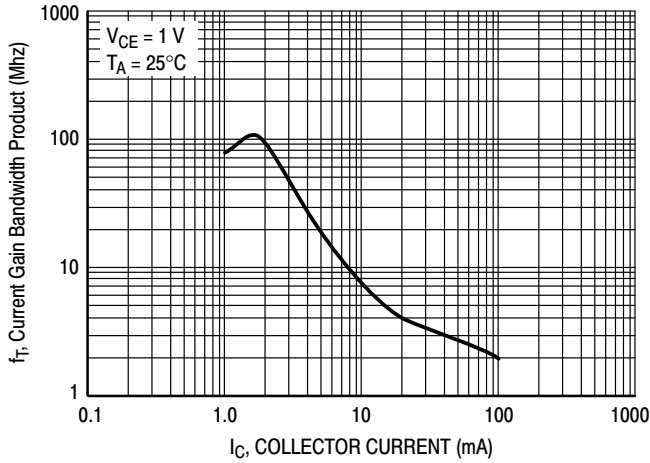

Figure 10. Current Gain Bandwidth Product

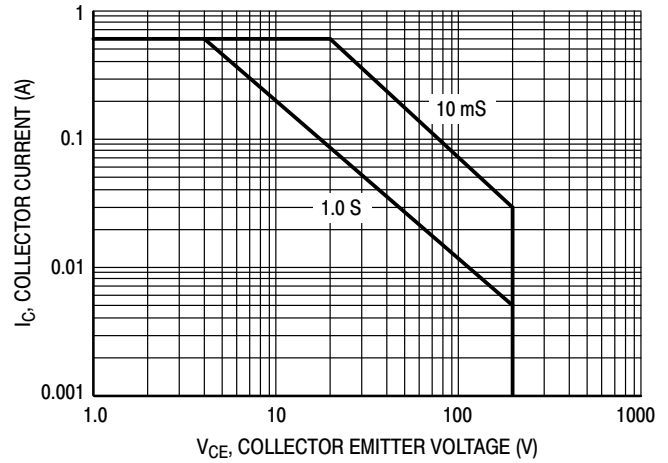

Figure 11. Safe Operating Area

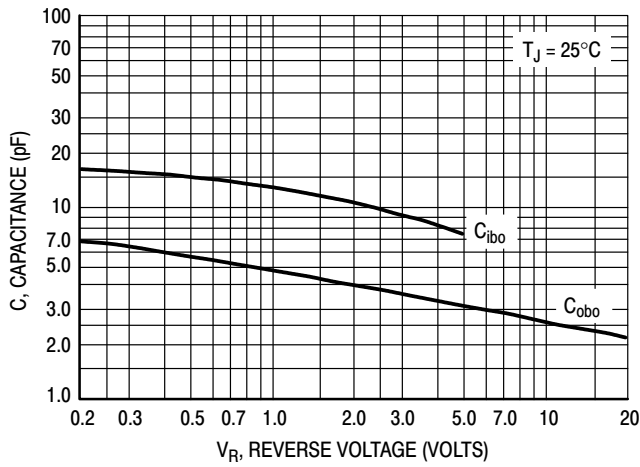

Figure 12. Capacitances

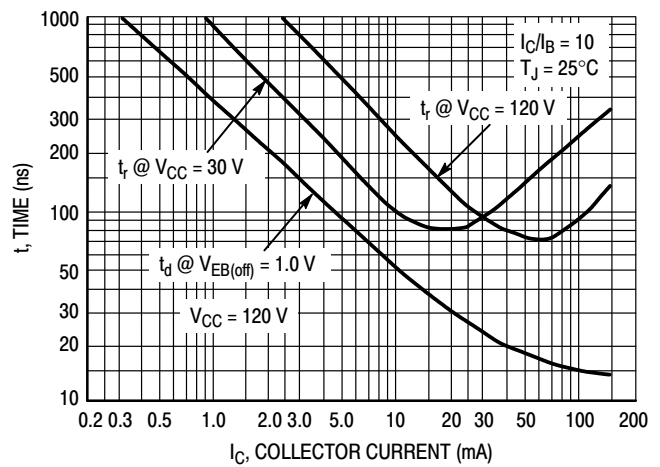
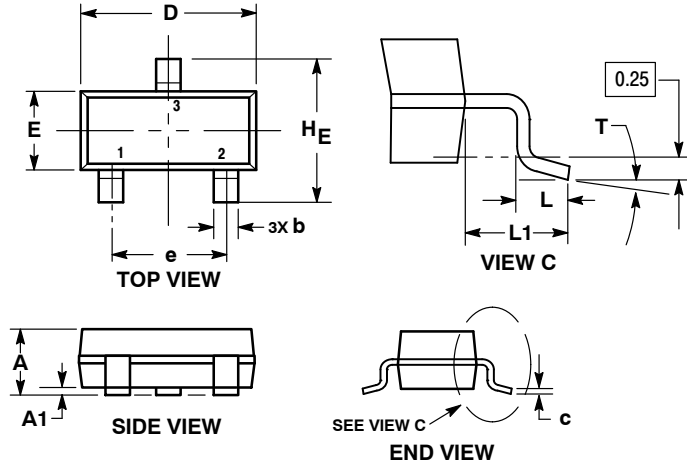

Figure 13. Turn-On Time

# MMBT5550L, MMBT5551L

## PACKAGE DIMENSIONS

SOT-23 (TO-236)  
CASE 318-08  
ISSUE AR



**NOTES:**

1. DIMENSIONING AND TOLERANCING PER ASME Y14.5M, 1994.
2. CONTROLLING DIMENSION: MILLIMETERS.
3. MAXIMUM LEAD THICKNESS INCLUDES LEAD FINISH. MINIMUM LEAD THICKNESS IS THE MINIMUM THICKNESS OF THE BASE MATERIAL.
4. DIMENSIONS D AND E DO NOT INCLUDE MOLD FLASH, PROTRUSIONS, OR GATE BURRS.

DIM	MILLIMETERS			INCHES		
	MIN	NOM	MAX	MIN	NOM	MAX
A	0.89	1.00	1.11	0.035	0.039	0.044
A1	0.01	0.06	0.10	0.000	0.002	0.004
b	0.37	0.44	0.50	0.015	0.017	0.020
c	0.08	0.14	0.20	0.003	0.006	0.008
D	2.80	2.90	3.04	0.110	0.114	0.120
E	1.20	1.30	1.40	0.047	0.051	0.055
e	1.78	1.90	2.04	0.070	0.075	0.080
L	0.30	0.43	0.55	0.012	0.017	0.022
L1	0.35	0.54	0.69	0.014	0.021	0.027
HE	2.10	2.40	2.64	0.083	0.094	0.104
T	0°	---	10°	0°	---	10°

- STYLE 6:  
PIN 1. BASE  
2. EMITTER  
3. COLLECTOR

### RECOMMENDED SOLDERING FOOTPRINT\*

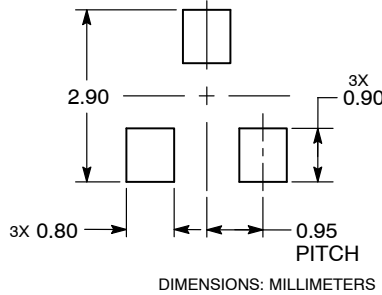

\*For additional information on our Pb-Free strategy and soldering details, please download the ON Semiconductor Soldering and Mounting Techniques Reference Manual, SOLDERRM/D.

ON Semiconductor and are trademarks of Semiconductor Components Industries, LLC dba ON Semiconductor or its subsidiaries in the United States and/or other countries. ON Semiconductor owns the rights to a number of patents, trademarks, copyrights, trade secrets, and other intellectual property. A listing of ON Semiconductor's product/patent coverage may be accessed at [www.onsemi.com/site/pdf/Patent-Marking.pdf](http://www.onsemi.com/site/pdf/Patent-Marking.pdf). ON Semiconductor reserves the right to make changes without further notice to any products herein. ON Semiconductor makes no warranty, representation or guarantee regarding the suitability of its products for any particular purpose, nor does ON Semiconductor assume any liability arising out of the application or use of any product or circuit, and specifically disclaims any and all liability, including without limitation special, consequential or incidental damages. Buyer is responsible for its products and applications using ON Semiconductor products, including compliance with all laws, regulations and safety requirements or standards, regardless of any support or applications information provided by ON Semiconductor. "Typical" parameters which may be provided in ON Semiconductor data sheets and/or specifications can and do vary in different applications and actual performance may vary over time. All operating parameters, including "Typicals" must be validated for each customer application by customer's technical experts. ON Semiconductor does not convey any license under its patent rights nor the rights of others. ON Semiconductor products are not designed, intended, or authorized for use as a critical component in life support systems or any FDA Class 3 medical devices or medical devices with a same or similar classification in a foreign jurisdiction or any devices intended for implantation in the human body. Should Buyer purchase or use ON Semiconductor products for any such unintended or unauthorized application, Buyer shall indemnify and hold ON Semiconductor and its officers, employees, subsidiaries, affiliates, and distributors harmless against all claims, costs, damages, and expenses, and reasonable attorney fees arising out of, directly or indirectly, any claim of personal injury or death associated with such unintended or unauthorized use, even if such claim alleges that ON Semiconductor was negligent regarding the design or manufacture of the part. ON Semiconductor is an Equal Opportunity/Affirmative Action Employer. This literature is subject to all applicable copyright laws and is not for resale in any manner.

### PUBLICATION ORDERING INFORMATION

**LITERATURE FULFILLMENT:**  
Literature Distribution Center for ON Semiconductor  
19521 E. 32nd Pkwy, Aurora, Colorado 80011 USA  
**Phone:** 303-675-2175 or 800-344-3860 Toll Free USA/Canada  
**Fax:** 303-675-2176 or 800-344-3867 Toll Free USA/Canada  
**Email:** [orderlit@onsemi.com](mailto:orderlit@onsemi.com)

**N. American Technical Support:** 800-282-9855 Toll Free  
USA/Canada  
**Europe, Middle East and Africa Technical Support:**  
Phone: 421 33 790 2910  
**Japan Customer Focus Center**  
Phone: 81-3-5817-1050

**ON Semiconductor Website:** [www.onsemi.com](http://www.onsemi.com)  
**Order Literature:** <http://www.onsemi.com/orderlit>

For additional information, please contact your local Sales Representative