

Chipsmall Limited consists of a professional team with an average of over 10 year of expertise in the distribution of electronic components. Based in Hongkong, we have already established firm and mutual-benefit business relationships with customers from,Europe,America and south Asia,supplying obsolete and hard-to-find components to meet their specific needs.

With the principle of “Quality Parts,Customers Priority,Honest Operation,and Considerate Service”,our business mainly focus on the distribution of electronic components. Line cards we deal with include Microchip,ALPS,ROHM,Xilinx,Pulse,ON,Everlight and Freescale. Main products comprise IC,Modules,Potentiometer,IC Socket,Relay,Connector.Our parts cover such applications as commercial,industrial, and automotives areas.

We are looking forward to setting up business relationship with you and hope to provide you with the best service and solution. Let us make a better world for our industry!



Contact us

Tel: +86-755-8981 8866 Fax: +86-755-8427 6832

Email & Skype: info@chipsmall.com Web: www.chipsmall.com

Address: A1208, Overseas Decoration Building, #122 Zhenhua RD., Futian, Shenzhen, China

Features

- Dual TVS in Common Anode Configuration
- 24W/40W Peak Power Dissipation Rating @ 1.0ms (Unidirectional)
- 225mW Power Dissipation
- Ideally Suited for Automated Insertion
- Low Leakage
- **Totally Lead-Free & Fully RoHS Compliant (Notes 1 & 2)**
- **Halogen and Antimony Free. "Green" Device (Note 3)**
- **Qualified to AEC-Q101 Standards for High Reliability**

Mechanical Data

- Case: SOT23
- Case Material: Molded Plastic "Green" Molding Compound. UL Flammability Classification 94V-0
- Moisture Sensitivity: Level 1 per J-STD-020
- Terminals: Solderable per MIL-STD-202, Method 208 ^(e3)
- Polarity: See Diagram
- Lead Free Plating (Matte Tin Finish annealed over Alloy 42 leadframe).
- ESD Rating Exceeding 16kV per the Human Body Model (Note 8)
- Marking Information: See Below
- Ordering Information: See Below
- Weight: 0.008 grams (approximate)



Top View

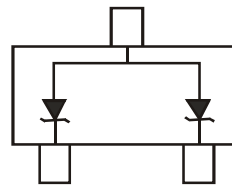

Device Schematic

Ordering Information (Note 4)

Part Number	Qualification	Case	Packaging
(Type Number)-7*-F	Commercial	SOT23	3000/Tape & Reel
(Type Number)Q-7*-F	Automotive	SOT23	3000/Tape & Reel

* Example: 5.6V type = MMBZ5V6AL-7-F.

- Notes:
1. No purposely added lead. Fully EU Directive 2002/95/EC (RoHS) & 2011/65/EU (RoHS 2) compliant.
 2. See <http://www.diodes.com> for more information about Diodes Incorporated's definitions of Halogen- and Antimony-free, "Green" and Lead-free.
 3. Halogen- and Antimony-free "Green" products are defined as those which contain <900ppm bromine, <900ppm chlorine (<1500ppm total Br + Cl) and <1000ppm antimony compounds.
 4. For packaging details, go to our website at <http://www.diodes.com>.

Marking Information

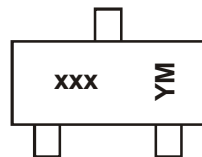

xxx = Product type marking code,
See Electrical Characteristics Table, Pages 2
YM = Date Code Marking
Y = Year (ex: A = 2013)
M = Month (ex: 9 = September)

Date Code Key

Year	2006	2007	2008	2009	2010	2011	2012	2013	2014	2015	2016	2017	2018
Code	T	U	V	W	X	Y	Z	A	B	C	D	E	F

Month	Jan	Feb	Mar	Apr	May	Jun	Jul	Aug	Sep	Oct	Nov	Dec
Code	1	2	3	4	5	6	7	8	9	O	N	D

Maximum Ratings (@T_A = +25°C, unless otherwise specified.)

Characteristic	Symbol	Value	Unit
Peak Power Dissipation MMBZ5V6AL - MMBZ10VAL (Note 6)	P _{pk}	24	W
Peak Power Dissipation MMBZ15VAL - MMBZ33VAL (Note 6)	P _{pk}	40	W

Thermal Characteristics

Characteristic	Symbol	Value	Unit
Power Dissipation (Note 5)	P _D	225	mW
Thermal Resistance, Junction to Ambient Air (Note 5)	R _{θJA}	556	°C/W
Operating and Storage Temperature Range	T _J , T _{STG}	-65 to +150	°C

Electrical Characteristics (@T_A = +25°C, unless otherwise specified.)

24 Watt (V_F = 0.9V max @ I_F = 10mA)

Type Number	Marking Code	V _{RWM}	Max Reverse Current, I _R @ V _{RWM} (Note 7)	Breakdown Voltage			@ I _T	Max. Clamping Voltage, V _C @ I _{PP} (Note 6)		Typical Temperature Coefficient of Reverse Voltage TC (mV/°C)
				V _{BR} (Note 7) (V)				V _C	I _{PP}	
				Volts	µA	Min		Nom	Max	
MMBZ5V6AL	K9A	3	5.0	5.32	5.6	5.88	20	8.0	3.0	1.8

24 Watt (V_F = 0.9V max @ I_F = 10mA)

Type Number	Marking Code	V _{RWM}	Max Reverse Current, I _R @ V _{RWM} (Note 7)	Breakdown Voltage			@ I _T	Max. Clamping Voltage, V _C @ I _{PP} (Note 6)		Typical Temperature Coefficient of Reverse Voltage TC (%/°C)
				V _{BR} (Note 7) (V)				V _C	I _{PP}	
				Volts	µA	Min		Nom	Max	
MMBZ6V2AL	K9B	3.0	0.5	5.89	6.2	6.51	1.0	8.7	2.76	+0.04
MMBZ6V8AL	K9C	4.5	0.5	6.46	6.8	7.14	1.0	9.6	2.5	+0.045
MMBZ9V1AL	K9D	6.0	0.3	8.65	9.1	9.56	1.0	14	1.7	+0.065
MMBZ10VAL	K9E	6.5	0.3	9.50	10	10.5	1.0	14.2	1.7	+0.065

40 Watt (V_F = 0.9V max @ I_F = 10mA)

Type Number	Marking Code	V _{RWM}	Max. Reverse Current, I _R @ V _{RWM} (Note 7)	Breakdown Voltage			@ I _T	Max. Clamping Voltage, V _C @ I _{PP} (Note 6)		Typical Temperature Coefficient of Reverse Voltage TC (%/°C)
				V _{BR} (Note 7) (V)				V _C	I _{PP}	
				Volts	nA	Min		Nom	Max	
MMBZ15VAL	K9K	12	50	14.25	15	15.75	1.0	21	1.9	+0.080
MMBZ18VAL	K9L	14.5	50	17.10	18	18.90	1.0	25	1.6	+0.090
MMBZ20VAL	K9N	17	50	19.00	20	21.00	1.0	28	1.4	+0.090
MMBZ27VAL	K9Q	22	50	25.65	27	28.35	1.0	40	1.0	+0.090
MMBZ33VAL	K9T	26	50	31.35	33	34.65	1.0	46	0.87	+0.090

- Notes:
- Device mounted on FR-4 PCB pad layout (2oz copper) as shown on Diodes, Inc. suggested pad layout AP02001, which can be found on our website at <http://www.diodes.com>.
 - Non-repetitive current pulse per Figure 2 and derate above T_A = +25°C per Figure 2.
 - Short duration pulse test used to minimize self-heating effect.
 - MMBZ5V6AL and MMBZ15VAL exceed 16kV ESD rating, all other voltages exceed 8kV ESD rating.

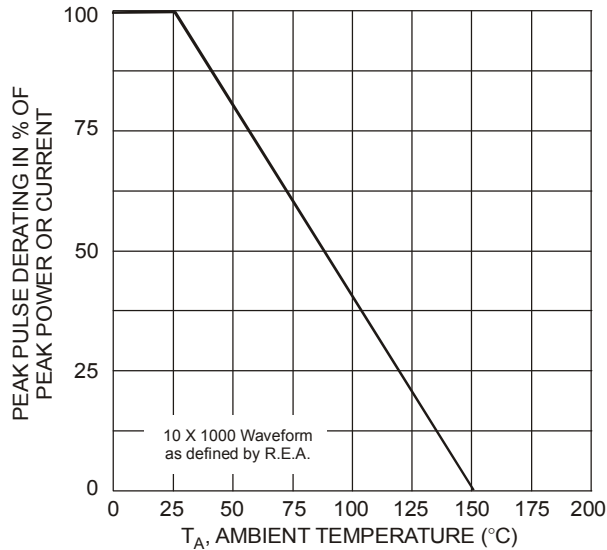

Fig. 1 Pulse Derating Curve

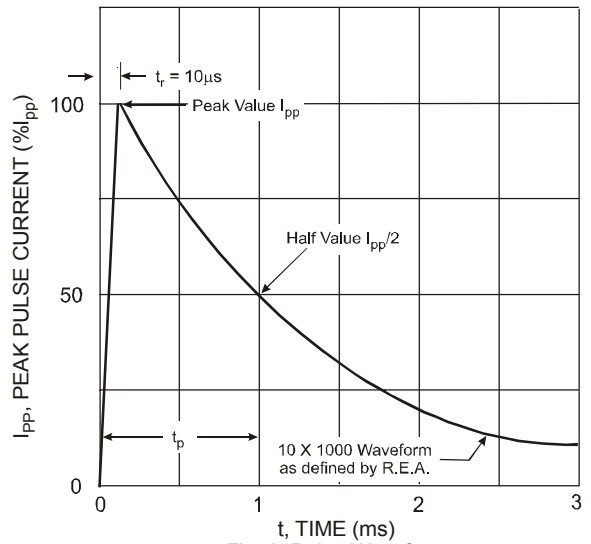

Fig. 2 Pulse Waveform

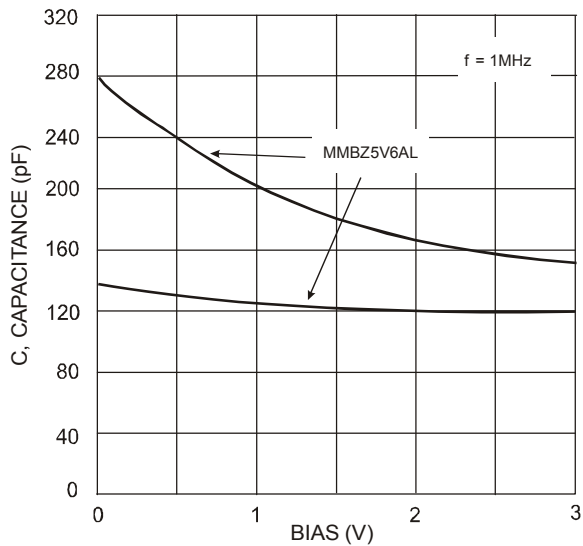

Fig. 3 Typical Capacitance vs. Bias Voltage
(Lower curve is Bidirectional mode,
Upper curve is Unidirectional mode)

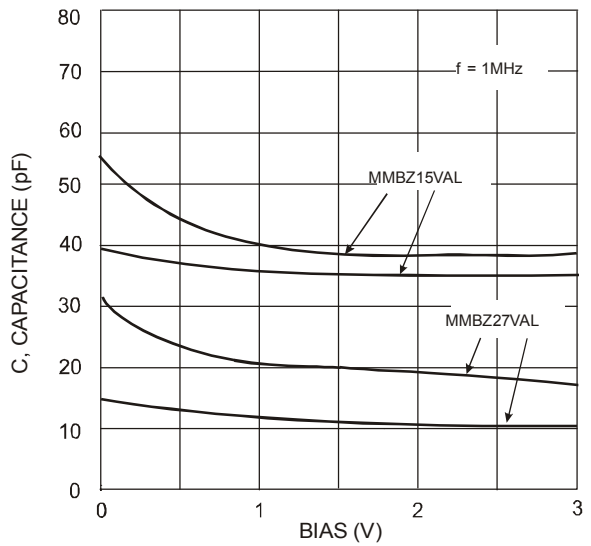

Fig. 4 Typical Capacitance vs. Bias Voltage
(Lower curve is Bidirectional mode,
Upper curve is Unidirectional mode)

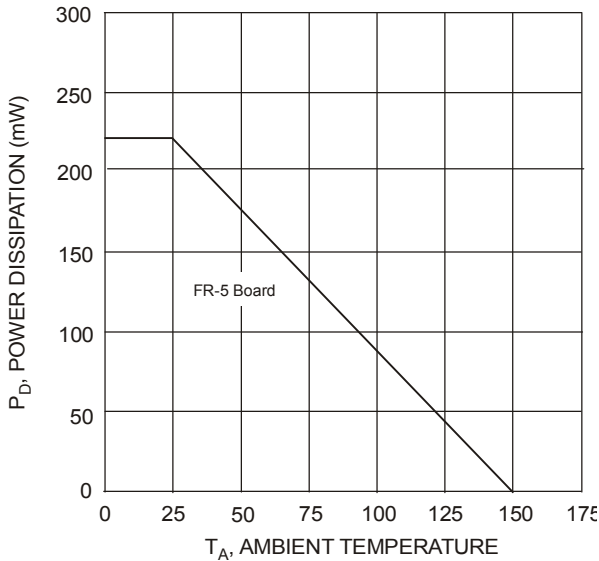

Fig. 5 Steady State Power Derating Curve

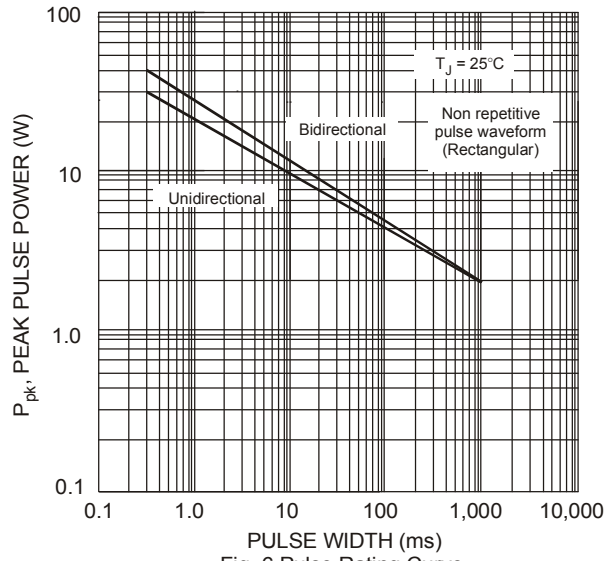

Fig. 6 Pulse Rating Curve, P_{pk} (W) vs. Pulse Width (ms)

Power is defined as $P_{pk} = V_C \times I_{pp}$

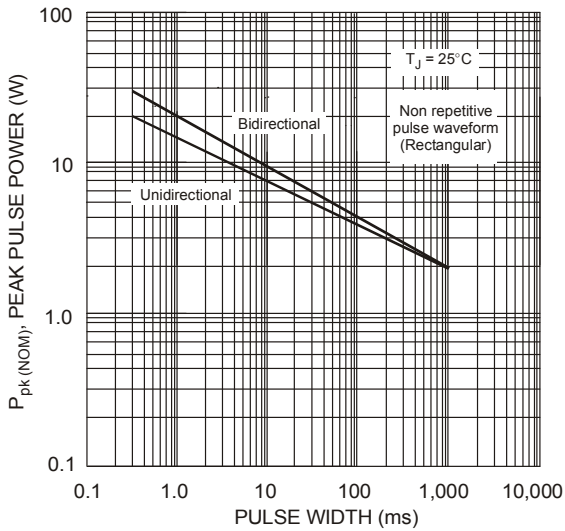
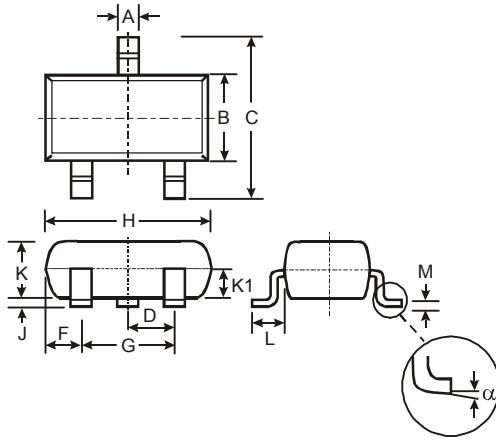

Fig. 7 Pulse Rating Curve, $P_{pk(NOM)}$ (W) vs. Pulse Width (ms)

Power is defined as $P_{pk(NOM)} = V_{BR(NOM)} \times I_{pp}$
 where $V_{BR(NOM)}$ is the nominal reverse breakdown voltage measured at the low test current used for voltage classification

Package Outline Dimensions



SOT23			
Dim	Min	Max	Typ
A	0.37	0.51	0.40
B	1.20	1.40	1.30
C	2.30	2.50	2.40
D	0.89	1.03	0.915
F	0.45	0.60	0.535
G	1.78	2.05	1.83
H	2.80	3.00	2.90
J	0.013	0.10	0.05
K	0.903	1.10	1.00
K1	-	-	0.400
L	0.45	0.61	0.55
M	0.085	0.18	0.11
α	0°	8°	-
All Dimensions in mm			

Suggested Pad Layout

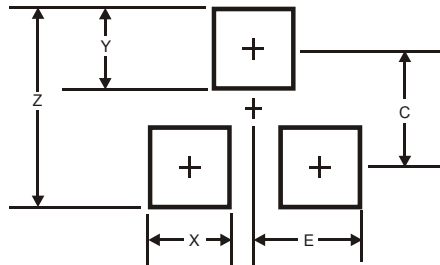

Dimensions	Value (in mm)
Z	2.9
X	0.8
Y	0.9
C	2.0
E	1.35

IMPORTANT NOTICE

DIODES INCORPORATED MAKES NO WARRANTY OF ANY KIND, EXPRESS OR IMPLIED, WITH REGARDS TO THIS DOCUMENT, INCLUDING, BUT NOT LIMITED TO, THE IMPLIED WARRANTIES OF MERCHANTABILITY AND FITNESS FOR A PARTICULAR PURPOSE (AND THEIR EQUIVALENTS UNDER THE LAWS OF ANY JURISDICTION).

Diodes Incorporated and its subsidiaries reserve the right to make modifications, enhancements, improvements, corrections or other changes without further notice to this document and any product described herein. Diodes Incorporated does not assume any liability arising out of the application or use of this document or any product described herein; neither does Diodes Incorporated convey any license under its patent or trademark rights, nor the rights of others. Any Customer or user of this document or products described herein in such applications shall assume all risks of such use and will agree to hold Diodes Incorporated and all the companies whose products are represented on Diodes Incorporated website, harmless against all damages.

Diodes Incorporated does not warrant or accept any liability whatsoever in respect of any products purchased through unauthorized sales channel. Should Customers purchase or use Diodes Incorporated products for any unintended or unauthorized application, Customers shall indemnify and hold Diodes Incorporated and its representatives harmless against all claims, damages, expenses, and attorney fees arising out of, directly or indirectly, any claim of personal injury or death associated with such unintended or unauthorized application.

Products described herein may be covered by one or more United States, international or foreign patents pending. Product names and markings noted herein may also be covered by one or more United States, international or foreign trademarks.

This document is written in English but may be translated into multiple languages for reference. Only the English version of this document is the final and determinative format released by Diodes Incorporated.

LIFE SUPPORT

Diodes Incorporated products are specifically not authorized for use as critical components in life support devices or systems without the express written approval of the Chief Executive Officer of Diodes Incorporated. As used herein:

A. Life support devices or systems are devices or systems which:

1. are intended to implant into the body, or
2. support or sustain life and whose failure to perform when properly used in accordance with instructions for use provided in the labeling can be reasonably expected to result in significant injury to the user.

B. A critical component is any component in a life support device or system whose failure to perform can be reasonably expected to cause the failure of the life support device or to affect its safety or effectiveness.

Customers represent that they have all necessary expertise in the safety and regulatory ramifications of their life support devices or systems, and acknowledge and agree that they are solely responsible for all legal, regulatory and safety-related requirements concerning their products and any use of Diodes Incorporated products in such safety-critical, life support devices or systems, notwithstanding any devices- or systems-related information or support that may be provided by Diodes Incorporated. Further, Customers must fully indemnify Diodes Incorporated and its representatives against any damages arising out of the use of Diodes Incorporated products in such safety-critical, life support devices or systems.

Copyright © 2013, Diodes Incorporated

www.diodes.com