



Chipsmall Limited consists of a professional team with an average of over 10 year of expertise in the distribution of electronic components. Based in Hongkong, we have already established firm and mutual-benefit business relationships with customers from,Europe,America and south Asia,supplying obsolete and hard-to-find components to meet their specific needs.

With the principle of “Quality Parts,Customers Priority,Honest Operation,and Considerate Service”,our business mainly focus on the distribution of electronic components. Line cards we deal with include Microchip,ALPS,ROHM,Xilinx,Pulse,ON,Everlight and Freescale. Main products comprise IC,Modules,Potentiometer,IC Socket,Relay,Connector.Our parts cover such applications as commercial,industrial, and automotives areas.

We are looking forward to setting up business relationship with you and hope to provide you with the best service and solution. Let us make a better world for our industry!



Contact us

Tel: +86-755-8981 8866 Fax: +86-755-8427 6832

Email & Skype: info@chipsmall.com Web: www.chipsmall.com

Address: A1208, Overseas Decoration Building, #122 Zhenhua RD., Futian, Shenzhen, China



MMC8A

MMC 8A -1 -□

① ② ③ ④

c  us
RoHS

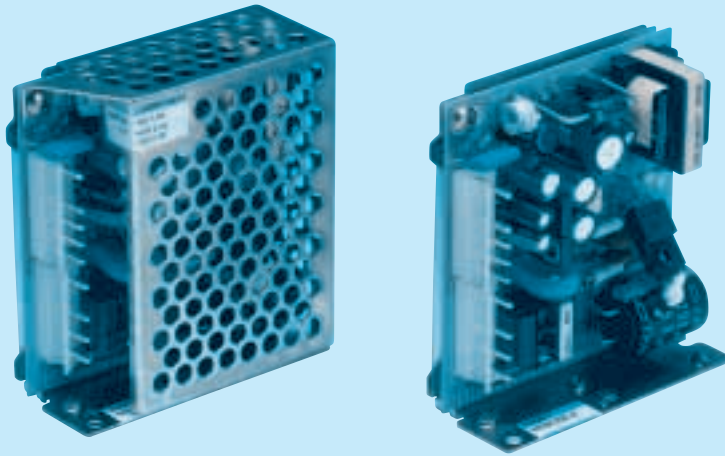

- ① Series name
- ② Output wattage
- ③ Output voltage combination
- ④ Optional *2
G : Low leakage current
N : with Cover

MMC

MODEL	MMC8A-1	MMC8A-2	MMC8A-3
DC OUTPUT	V1	+5V 1.2A	+5V 1.1A
	V2	+12V 0.1A	+15V 0.1A
	V3	-12V 0.1A	-15V 0.1A

SPECIFICATIONS

	MODEL	MMC8A-1			MMC8A-2			MMC8A-3			
INPUT	VOLTAGE[V]	AC85 - 132 1 φ or DC110 - 170									
	CURRENT[A]	ACIN 100V	0.3typ (Io=100%)								
	FREQUENCY[Hz]	47 - 440 or DC									
	EFFICIENCY[%]	ACIN 100V	68typ (Io=100%)								
	INRUSH CURRENT[A]	ACIN 100V	20typ (Io=100%)								
OUTPUT	VOLTAGE[V]	+5	+12	-12	+5	+15	-15	+5	+12	-5	
	CURRENT[A]	1.2	0.1	0.1	1.1	0.1	0.1	1.2	0.1	0.1	
	MINIMUM CURRENT[A]	0	0	0	0	0	0	0	0	0	
	LINE REGULATION[mV]	20max	48max	48max	20max	60max	60max	20max	48max	20max	
	LOAD REGULATION[mV]	60max	120max	120max	60max	150max	150max	60max	120max	100max	
	RIPPLE[mVp-p]	*1	80max	120max	120max	80max	120max	120max	80max	120max	120max
	RIPPLE NOISE[mVp-p]	*1	120max	150max	150max	120max	150max	150max	120max	150max	150max
	TEMPERATURE REGULATION[mV]	0 to +50°C	50max	350max	350max	50max	350max	350max	50max	350max	350max
	START-UP TIME[ms]	100max (ACIN 85V, Io=100%)									
	HOLD-UP TIME[ms]	15typ (ACIN 85V, Io=100%)									
PROTECTION CIRCUIT	OVERCURRENT PROTECTION	Works over 105% of rating and recovers automatically									
	INPUT-CASE, OUTPUT	AC2,000V 1minute, DC500V 50MΩmin (At Room Temperature)									
ISOLATION	OUTPUT-CASE	AC500V 1minute, DC500V 50MΩmin (At Room Temperature)									
	OUTPUT-OUTPUT(V1-V2,V3)	AC100V 1minute, DC100V 10MΩmin (At Room Temperature)									
ENVIRONMENT	OPERATING TEMP.,HUMID.AND ALTITUDE	0 to +65°C, 20 - 90%RH (Non condensing) (Refer to DERATING CURVE), 3,000m (10,000feet) max									
	STORAGE TEMP.,HUMID.AND ALTITUDE	-20 to +75°C, 20 - 90%RH (Non condensing), 9,000m (30,000feet) max									
	VIBRATION	10 - 55Hz, 19.6m/s ² (2G), 3minutes period, 30minutes each along X, Y and Z axis									
	IMPACT	98.0m/s ² (10G), 20ms, once each X, Y and Z axis									
SAFETY AND NOISE REGULATIONS	AGENCY APPROVALS	UL60950-1, C-UL Complies with DEN-AN									
	CONDUCTED NOISE	Complies with FCC-B									

*1 Measured by 20MHz oscilloscope or Ripple-Noise meter(equivalent to KEISOKU-GIKEN : RM101).
 *2 Please contact us about safety approvals for the model with option.
 * When units are operated with chassis and cover, derating is required.
 * Avoid prolonged use under over-load.

External view

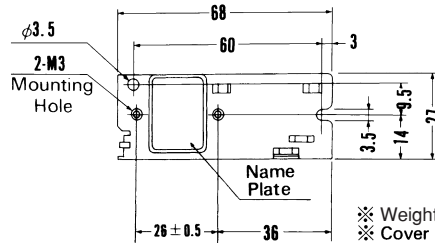
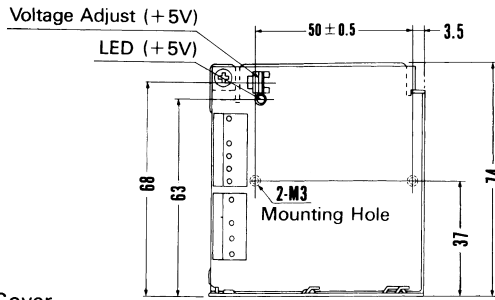
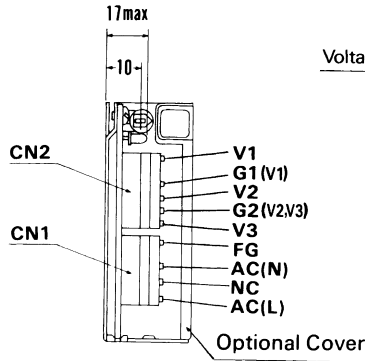

*V1 is isolated from V2 and V3.

I/O Connector	Mating Connector	Terminal
CN1	10-31-1048	10-63-3044
CN2	09-65-2059	09-50-1053

Chain : 08-70-1031
Loose : 08-70-1030

(Mfr : Molex)

※ Weight : 150g max
※ Cover is optional
※ Tolerance : ± 1
※ Dimensions in mm.

※ Mounting torque : 0.6N·m (6.3kgf·cm) max

Performance data

■ STATIC CHARACTERISTICS (MMC8A-1)

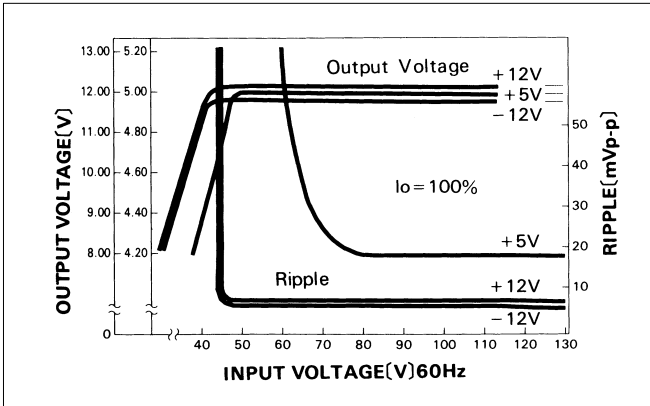

■ RISE TIME & FALL TIME (MMC8A-1)

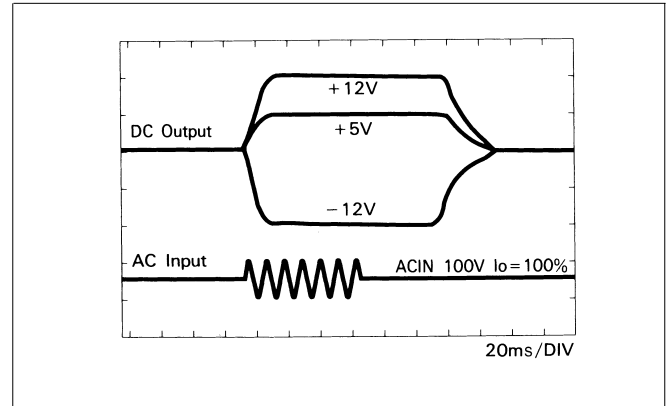

■ OVERCURRENT CHARACTERISTICS (MMC8A-1)

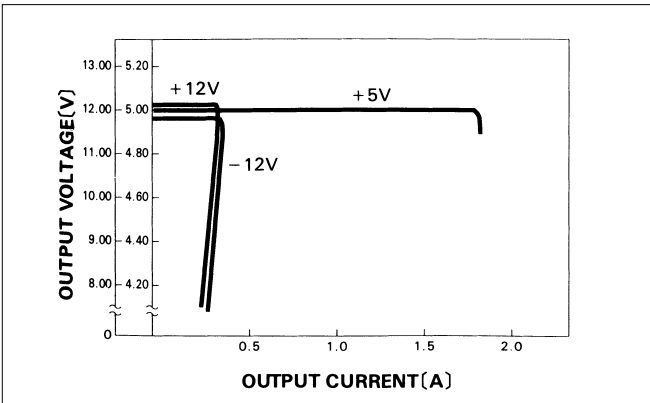

■ DERATING CURVE

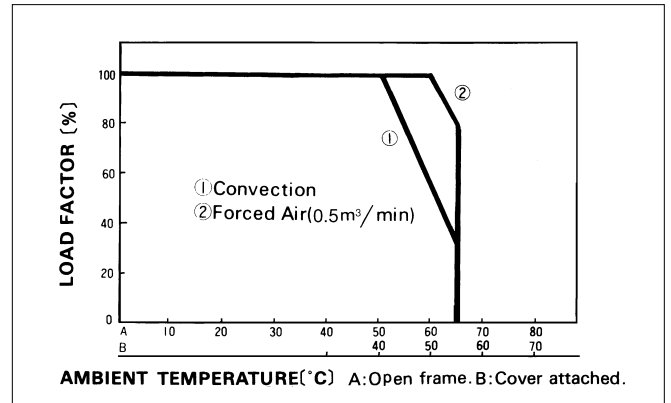

AMBIENT TEMPERATURE(°C) A: Open frame B: Cover attached.

MMC50A

MMC 50A -1 -□

① ② ③ ④

RoHS

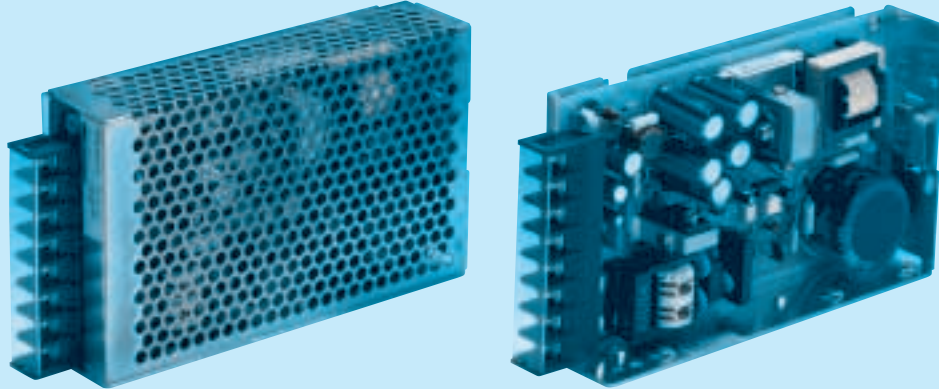

- ① Series name
- ② Output wattage
- ③ Output voltage combination
- ④ Optional *3
 C :with Coating
 G :Low leakage current
 J :Connector type
 N :with Cover

MODEL	MMC50A-1	MMC50A-2	MMC50A-3	MMC50A-4
DC OUTPUT	V1	+5V 5.0A	+5V 5.0A	+5V 5.0A
	V2	+12V 1.5(Peak 2.0)A	+15V 1.2A	+12V 1.5(Peak 2.0)A
	V3	-12V 0.5A	-15V 0.5A	-5V 0.5A

SPECIFICATIONS

	MODEL	MMC50A-1	MMC50A-2	MMC50A-3	MMC50A-4									
INPUT	VOLTAGE[V]	AC85 - 132 1 φ or DC110 - 170												
	CURRENT[A]	ACIN 100V	1.5typ (Io=100%)											
	FREQUENCY[Hz]	47 - 440 or DC												
	EFFICIENCY[%]	ACIN 100V	70typ (Io=100%)											
	INRUSH CURRENT[A]	ACIN 100V	30typ (Io=100%) (At cold start)											
OUTPUT	VOLTAGE[V]	+5	+12	-12	+5	+15	-15	+5	+12	-5	+5	+12	-12	
	CURRENT[A]	*1 5	1.5 (Peak2)	0.5	5	1.2	0.5	5	1.5 (Peak2)	0.5	7	1 (Peak1.5)	0.3	
	MINIMUM CURRENT[A]	0.75	0	0	0.75	0	0	0.75	0	0	0.75	0	0	
	LINE REGULATION[mV]	20max	48max	100max	20max	60max	60max	20max	48max	20max	20max	48max	48max	
	LOAD REGULATION[mV]	40max	150max	150max	40max	150max	150max	40max	150max	100max	40max	150max	150max	
	RIPPLE[mVp-p]	*2 80max	120max	120max	80max	120max	120max	80max	120max	120max	80max	120max	120max	
	RIPPLE NOISE[mVp-p]	*2 120max	150max	150max	120max	150max	150max	120max	150max	150max	120max	150max	150max	
	TEMPERATURE REGULATION[mV]	0 to +50°C	50max	350max	350max	50max	350max	350max	50max	350max	350max	50max	350max	
	START-UP TIME[ms]	100max (ACIN 85V, Io=100%)												
	HOLD-UP TIME[ms]	15typ (ACIN 85V, Io=100%)												
OUTPUT VOLTAGE ADJUSTMENT RANGE[V]	5.00 - 5.25	Fixed	Fixed	5.00 - 5.25	Fixed	Fixed	5.00 - 5.25	Fixed	Fixed	5.00 - 5.25	Fixed	Fixed		
OUTPUT VOLTAGE SETTING[V]	—	11.40 to 12.60	-11.40 to -12.60	—	14.25 to 15.75	-14.25 to -15.75	—	11.40 to 12.60	-4.75 to -5.25	—	11.40 to 12.60	-11.40 to -12.60		
PROTECTION CIRCUIT	OVERCURRENT PROTECTION	Works over 105% of rating (V2 works at peak current) and recovers automatically												
	OVERVOLTAGE PROTECTION	Works at 115 - 140% of rating (+5V)												
ISOLATION	INPUT-CASE, OUTPUT	AC2.000V 1minute, DC500V 50MΩmin (At Room Temperature)												
	OUTPUT-CASE	AC500V 1minute, DC500V 50MΩmin (At Room Temperature)												
	OUTPUT-OUTPUT(V1-V2,V3)	AC100V 1minute, DC100V 10MΩmin (At Room Temperature)												
ENVIRONMENT	OPERATING TEMP.,HUMID.AND ALTITUDE	0 to +65°C, 20 - 90%RH (Non condensing) (Refer to DERATING CURVE), 3,000m (10,000feet) max												
	STORAGE TEMP.,HUMID.AND ALTITUDE	-20 to +75°C, 20 - 90%RH (Non condensing), 9,000m (30,000feet) max												
	VIBRATION	10 - 55Hz, 19.6m/s ² (2G), 3minutes period, 30minutes each along X, Y and Z axis												
	IMPACT	196.1m/s ² (20G), 11ms, once each X, Y and Z axis												
SAFETY AND NOISE REGULATIONS	AGENCY APPROVALS	UL60950-1, C-UL Complies with DEN-AN												
	CONDUCTED NOISE	Complies with FCC-A												

*1 Peak current for 30 seconds.
 *2 Measured by 20MHz oscilloscope or Ripple-Noise meter(equivalent to KEISOKU-GIKEN : RM101).
 *3 Please contact us about safety approvals for the model with option.
 * When units are operated with chassis and cover, derating is required.
 * Avoid prolonged use under over-load.

External view

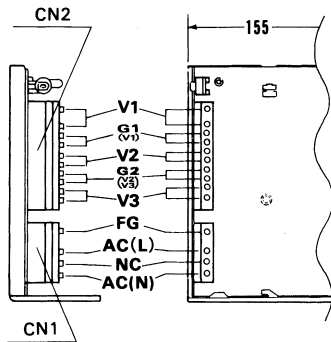

I/O Connector	Mating Connector	Terminal
CN1	10-31-1048	10-63-3044
CN2	09-65-2109	09-50-1103

(Mfr : Molex)

※Use J cover for connector type.

Connector type

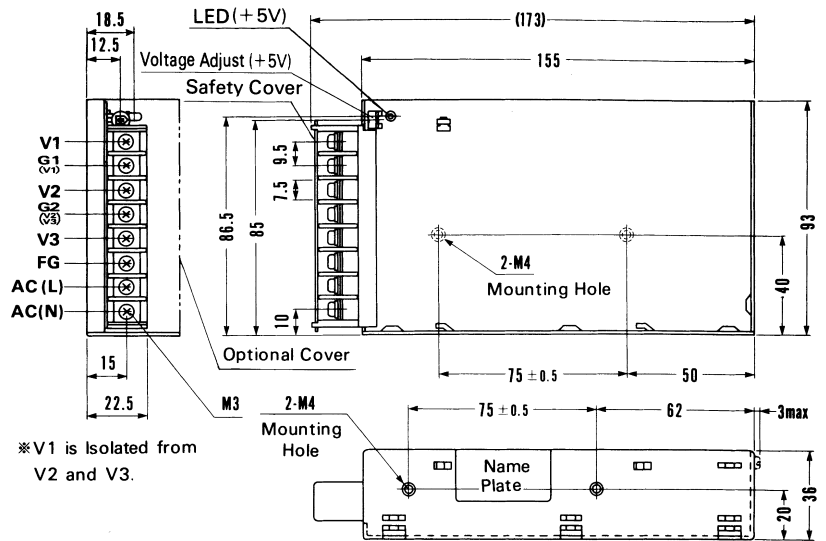

※V1 is isolated from V2 and V3.

※Mounting torque : 1.2N·m (12.8kgf·cm) max

Barrier strip type

※Weight : 400g max

※Cover is optional

※Tolerance: ±1

※Dimensions in mm.

Performance data

STATIC CHARACTERISTICS (MMC50A-1)

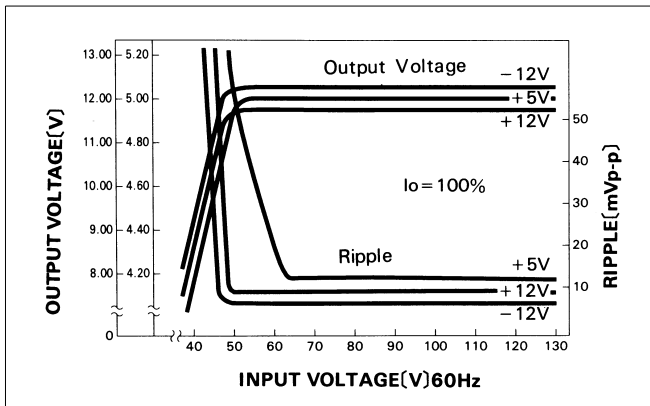

RISE TIME & FALL TIME (MMC50A-1)

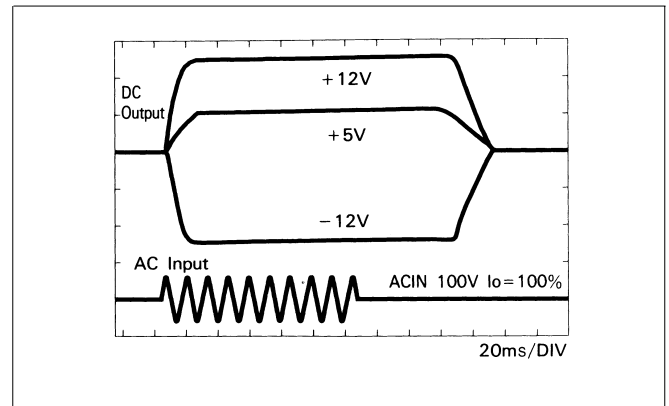

OVERCURRENT CHARACTERISTICS (MMC50A-1)

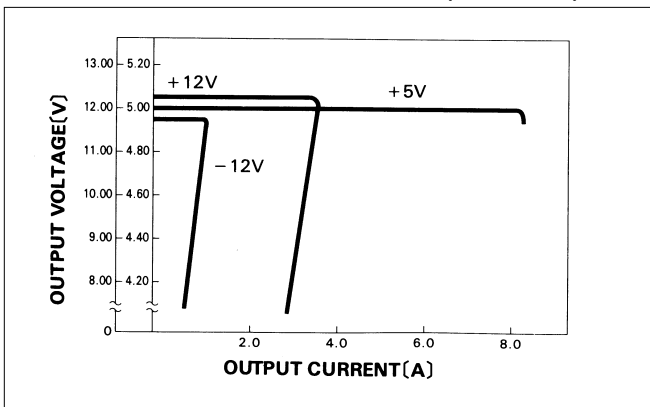

DERATING CURVE

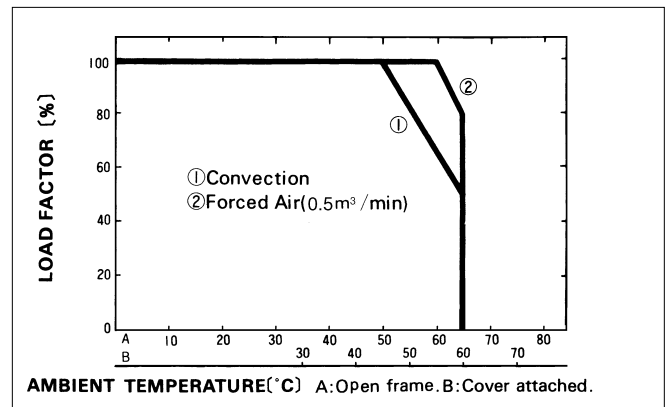

AMBIENT TEMPERATURE(°C) A: Open frame. B: Cover attached.

MMC75B

MMC 75B -1 -□

① ② ③ ④

c  us
RoHS

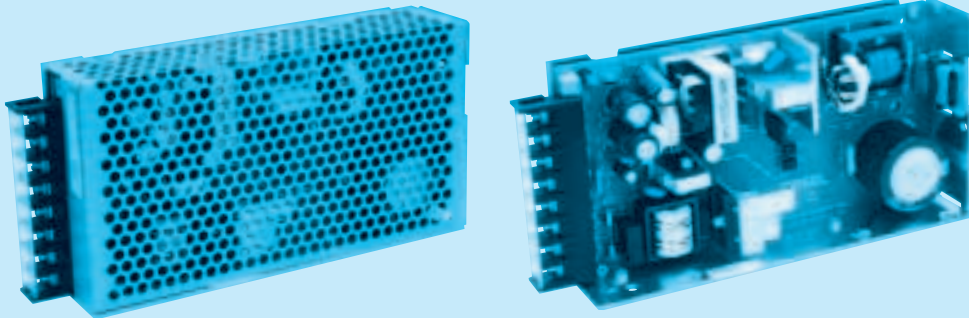

- ① Series name
- ② Output wattage
- ③ Output voltage combination
- ④ Optional *2
C :with Coating
G :Low leakage current
J :Connector type
N :with Cover

MMC

MODEL	MMC75B-1	MMC75B-2	MMC75B-3	MMC75B-4
DC OUTPUT	V1	+5V 8.0A	+5V 8.0A	+5V 8.0A
	V2	+12V 2.5A	+15V 1.8A	+12V 2.5A
	V3	-12V 0.5A	-15V 0.5A	-5V 0.5A

SPECIFICATIONS

	MODEL	MMC75B-1	MMC75B-2	MMC75B-3	MMC75B-4									
INPUT	VOLTAGE[V]	AC85 - 132 1φ or DC110 - 170												
	CURRENT[A]	ACIN 100V 2.1typ (Io=100%)												
	FREQUENCY[Hz]	47 - 440 or DC												
	EFFICIENCY[%]	ACIN 100V 75typ (Io=100%)												
	INRUSH CURRENT[A]	ACIN 100V 20typ (Io=100%)												
OUTPUT	VOLTAGE[V]	+5	+12	-12	+5	+15	-15	+5	+12	-5	+5	+12	-12	
	CURRENT[A]	8	2.5	0.5	8	1.8	0.5	8	2.5	0.5	6	3.2	0.5	
	MINIMUM CURRENT[A]	1.5	0	0	1.5	0	0	1.5	0	0	1.5	0	0	
	LINE REGULATION[mV]	20max	48max	48max	20max	60max	60max	20max	48max	20max	20max	48max	100max	
	LOAD REGULATION[mV]	40max	100max	150max	40max	120max	150max	40max	100max	100max	40max	100max	150max	
	RIPPLE[mVp-p]	*1 80max	120max	120max	80max	120max	120max	80max	120max	120max	80max	120max	120max	
	RIPPLE NOISE[mVp-p]	*1 120max	150max	150max	120max	150max	150max	120max	150max	150max	120max	150max	150max	
	TEMPERATURE REGULATION[mV]	0 to +50°C	50max	120max	350max	50max	150max	350max	50max	120max	350max	50max	120max	350max
	START-UP TIME[ms]	200max (ACIN 85V, Io=100%)												
	HOLD-UP TIME[ms]	15typ (ACIN 85V, Io=100%)												
OUTPUT VOLTAGE ADJUSTMENT RANGE[V]	5.00 - 5.25	Fixed	Fixed	5.00 - 5.25	Fixed	Fixed	5.00 - 5.25	Fixed	Fixed	5.00 - 5.25	Fixed	Fixed		
OUTPUT VOLTAGE SETTING[V]	—	11.40 to 12.60	-11.40 to -12.60	—	14.25 to 15.75	-14.25 to -15.75	—	11.40 to 12.60	-4.75 to -5.25	—	11.40 to 12.60	-11.40 to -12.60		
PROTECTION CIRCUIT	OVERCURRENT PROTECTION	Works over 105% of rating and recovers automatically												
	OVERVOLTAGE PROTECTION	Works at 115 - 140% of rating (+5V)												
ISOLATION	INPUT-CASE, OUTPUT	AC2,000V 1minute, DC500V 50MΩmin (At Room Temperature)												
	OUTPUT-CASE	AC500V 1minute, DC500V 50MΩmin (At Room Temperature)												
	OUTPUT-OUTPUT(V1-V2,V3)	AC100V 1minute, DC100V 10MΩmin (At Room Temperature)												
ENVIRONMENT	OPERATING TEMP.,HUMID.AND ALTITUDE	0 to +65°C, 20 - 90%RH (Non condensing) (Refer to DERATING CURVE), 3,000m (10,000feet) max												
	STORAGE TEMP.,HUMID.AND ALTITUDE	-20 to +75°C, 20 - 90%RH (Non condensing), 9,000m (30,000feet) max												
	VIBRATION	10 - 55Hz, 19.6m/s ² (2G), 3minutes period, 30minutes each along X, Y and Z axis												
	IMPACT	196.1m/s ² (20G), 11ms, once each X, Y and Z axis												
SAFETY AND NOISE REGULATIONS	AGENCY APPROVALS	UL60950-1, C-UL Complies with DEN-AN												
	CONDUCTED NOISE	Complies with FCC-A												

*1 Measured by 20MHz oscilloscope or Ripple-Noise meter(equivalent to KEISOKU-GIKEN : RM101).
 *2 Please contact us about safety approvals for the model with option.
 * When units are operated with chassis and cover, derating is required.
 * Avoid prolonged use under over-load.

External view

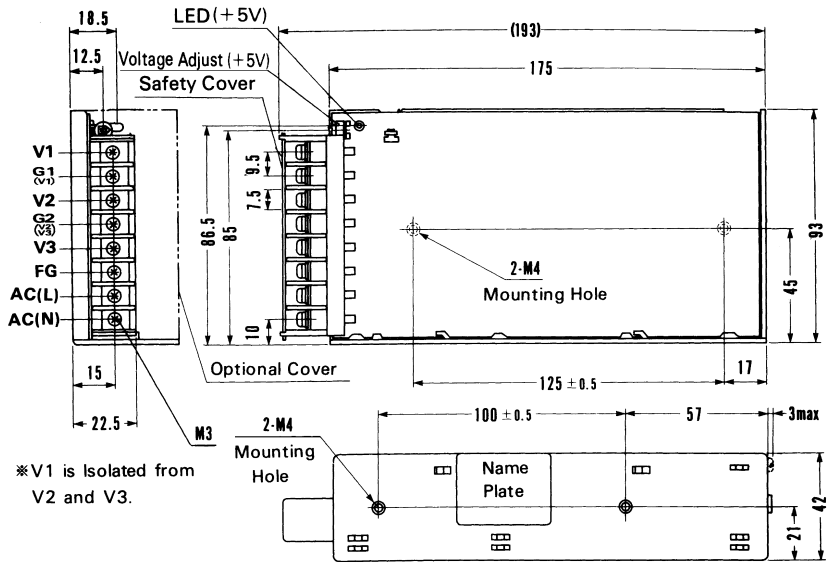
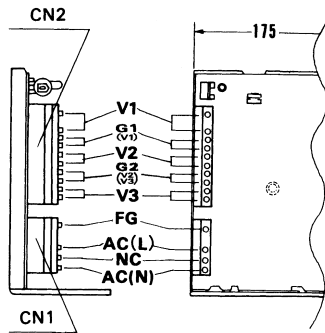

I/O Connector	Mating Connector	Terminal	
CN1	10-31-1048	10-63-3044	Chain : 08-70-1031
CN2	09-65-2109	09-50-1103	Loose : 08-70-1030

(Mfr : Molex)

※Use J cover for connector type.

Connector type

※V1 is isolated from V2 and V3.

※Mounting torque : 1.2N·m (12.8kgf·cm) max

Barrier strip type

※Weight : 600g max

※Cover is optional

※Tolerance : ± 1

※Dimensions in mm.

Performance data

■STATIC CHARACTERISTICS (MMC75B-4)

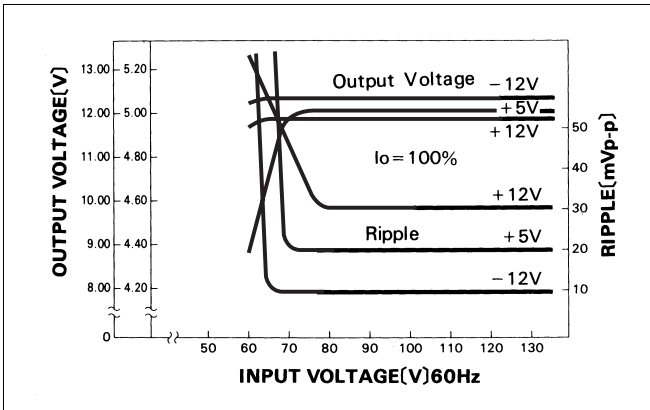

■RISE TIME & FALL TIME (MMC75B-4)

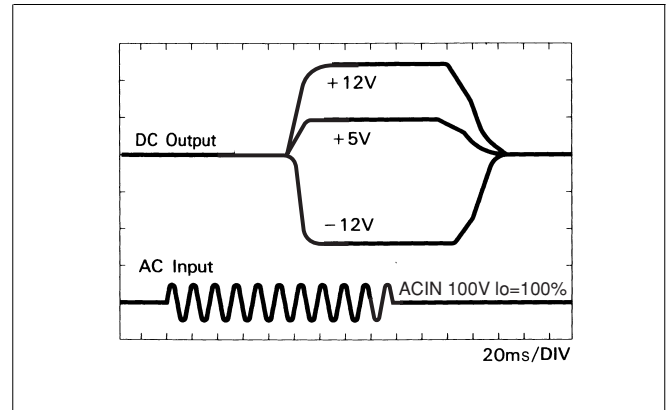

■OVERCURRENT CHARACTERISTICS (MMC75B-4)

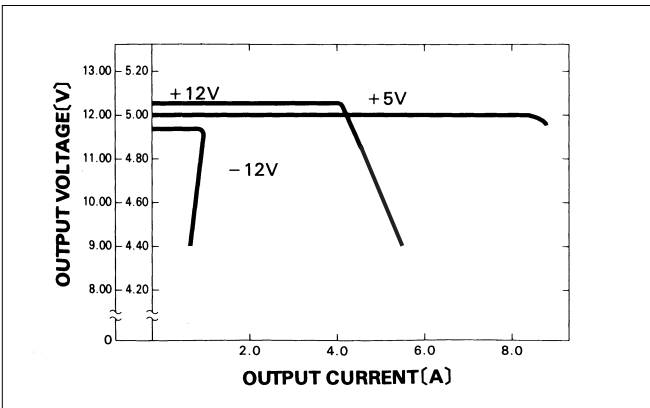

■DERATING CURVE

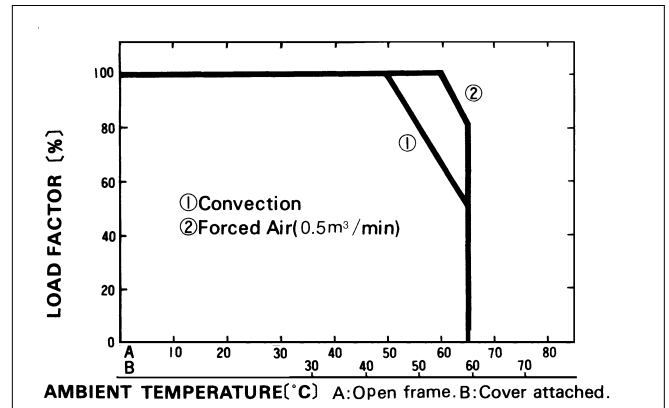

MMC100B

MMC 100B -1 -□

① ② ③ ④

c  us
RoHS

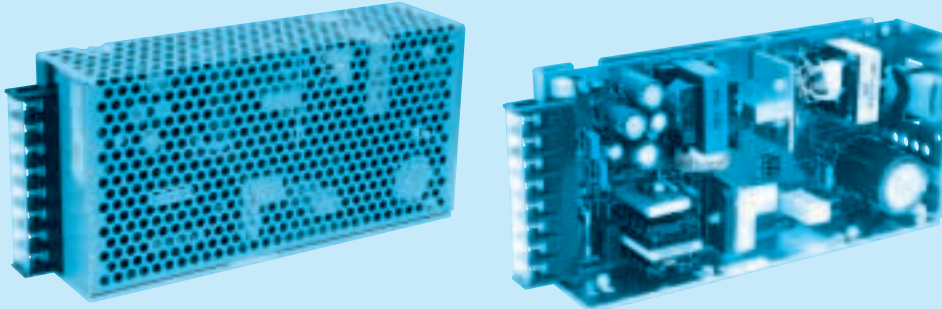

- ① Series name
- ② Output wattage
- ③ Output voltage combination
- ④ Optional *2
C :with Coating
G :Low leakage current
J :Connector type
N :with Cover

MMC

MODEL		MMC100B-1	MMC100B-2	MMC100B-3	MMC100B-4
DC OUTPUT	V1	+5V 13.0A	+5V 13.0A	+5V 13.0A	+5V 8.0A
	V2	+12V 2.0A	+15V 1.5A	+12V 2.0A	+12V 4.0A
	V3	-12V 1.0A	-15V 1.0A	-5V 1.0A	-12V 1.0A

SPECIFICATIONS

	MODEL	MMC100B-1			MMC100B-2			MMC100B-3			MMC100B-4			
INPUT	VOLTAGE[V]	AC85 - 132 1φ or DC110 - 170												
	CURRENT[A]	ACIN 100V	2.8typ (Io=100%)											
	FREQUENCY[Hz]	47 - 440 or DC												
	EFFICIENCY[%]	ACIN 100V	75typ (Io=100%)											
	INRUSH CURRENT[A]	ACIN 100V	25typ (Io=100%)											
OUTPUT	VOLTAGE[V]	+5	+12	-12	+5	+15	-15	+5	+12	-5	+5	+12	-12	
	CURRENT[A]	13	2	1	13	1.5	1	13	2	1	8	4	1	
	MINIMUM CURRENT[A]	1.5	0	0	1.5	0	0	1.5	0	0	1.5	0	0	
	LINE REGULATION[mV]	20max	48max	48max	20max	60max	60max	20max	48max	20max	20max	48max	100max	
	LOAD REGULATION[mV]	40max	100max	150max	40max	120max	150max	40max	100max	100max	40max	100max	150max	
	RIPPLE[mVp-p]	*1	80max	120max	120max	80max	120max	120max	80max	120max	120max	80max	120max	120max
	RIPPLE NOISE[mVp-p]	*1	120max	150max	150max	120max	150max	150max	120max	150max	150max	120max	150max	150max
	TEMPERATURE REGULATION[mV]	0 to +50°C	50max	120max	350max	50max	150max	350max	50max	120max	350max	50max	120max	350max
	START-UP TIME[ms]	200max (ACIN 85V, Io=100%)												
	HOLD-UP TIME[ms]	15typ (ACIN 85V, Io=100%)												
OUTPUT VOLTAGE ADJUSTMENT RANGE[V]	5.00 - 5.25	Fixed	Fixed	5.00 - 5.25	Fixed	Fixed	5.00 - 5.25	Fixed	Fixed	5.00 - 5.25	Fixed	Fixed		
OUTPUT VOLTAGE SETTING[V]	—	11.40 to 12.60	-11.40 to -12.60	—	14.25 to 15.75	-14.25 to -15.75	—	11.40 to 12.60	-4.75 to -5.25	—	11.40 to 12.60	-11.40 to -12.60		
PROTECTION CIRCUIT	OVERCURRENT PROTECTION	Works over 105% of rating and recovers automatically												
	OVERVOLTAGE PROTECTION	Works at 115 - 140% of rating (+5V)												
ISOLATION	INPUT-CASE, OUTPUT	AC2,000V 1minute, DC500V 50MΩmin (At Room Temperature)												
	OUTPUT-CASE	AC500V 1minute, DC500V 50MΩmin (At Room Temperature)												
	OUTPUT-OUTPUT(V1-V2,V3)	AC100V 1minute, DC100V 10MΩmin (At Room Temperature)												
ENVIRONMENT	OPERATING TEMP.,HUMID.AND ALTITUDE	0 to +65°C, 20 - 90%RH (Non condensing) (Refer to DERATING CURVE), 3,000m (10,000feet) max												
	STORAGE TEMP.,HUMID.AND ALTITUDE	-20 to +75°C, 20 - 90%RH (Non condensing), 9,000m (30,000feet) max												
	VIBRATION	10 - 55Hz, 19.6m/s ² (2G), 3minutes period, 30minutes each along X, Y and Z axis												
	IMPACT	196.1m/s ² (20G), 11ms, once each X, Y and Z axis												
SAFETY AND NOISE REGULATIONS	AGENCY APPROVALS	UL60950-1, C-UL Complies with DEN-AN												
	CONDUCTED NOISE	Complies with FCC-A												

*1 Measured by 20MHz oscilloscope or Ripple-Noise meter(equivalent to KEISOKU-GIKEN : RM101).
 *2 Please contact us about safety approvals for the model with option.
 * When units are operated with chassis and cover, derating is required.
 * Avoid prolonged use under over-load.

External view

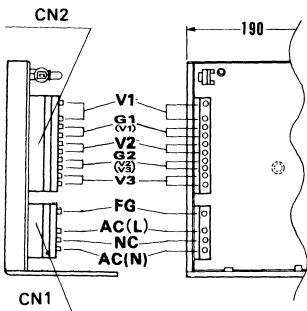

I/O Connector	Mating Connector	Terminal
CN1	10-31-1048	10-63-3044
CN2	09-65-2109	09-50-1103

Chain : 08-70-1031
Loose : 08-70-1030
(Mfr : Molex)

Connector type

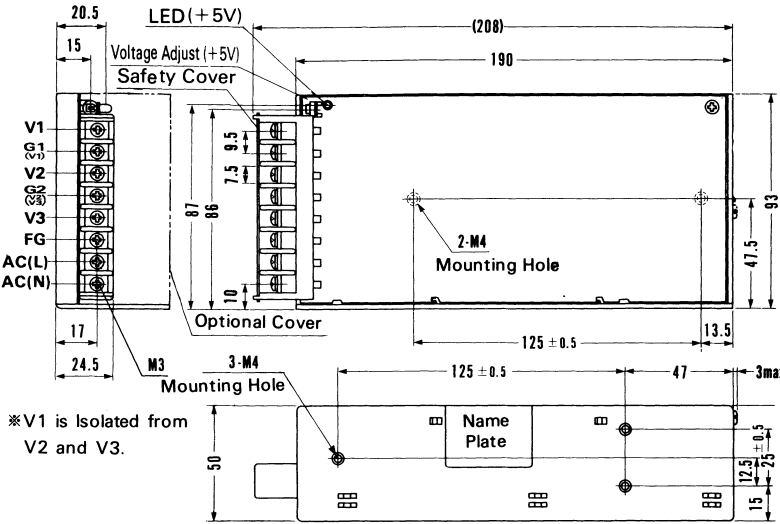

※ V1 is isolated from V2 and V3.

※ Mounting torque : 1.2N·m (12.8kgf·cm) max

※ Weight : 700g max

Barrier strip type

※ Cover is optional.

※ Tolerance: ± 1

※ Dimensions in mm.

Performance data

■ STATIC CHARACTERISTICS (MMC100B-4)

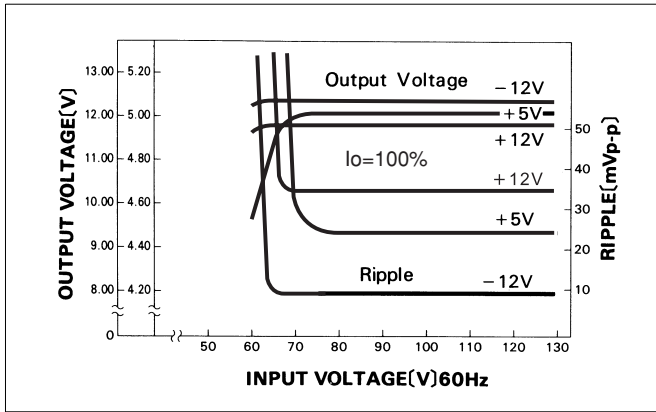

■ RISE TIME & FALL TIME (MMC100B-4)

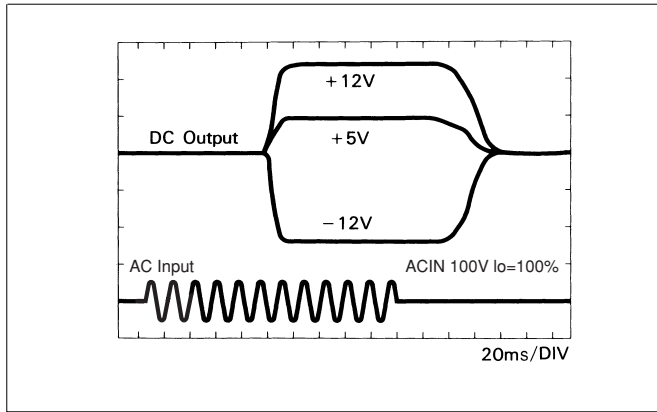

■ OVERCURRENT CHARACTERISTICS (MMC100B-4)

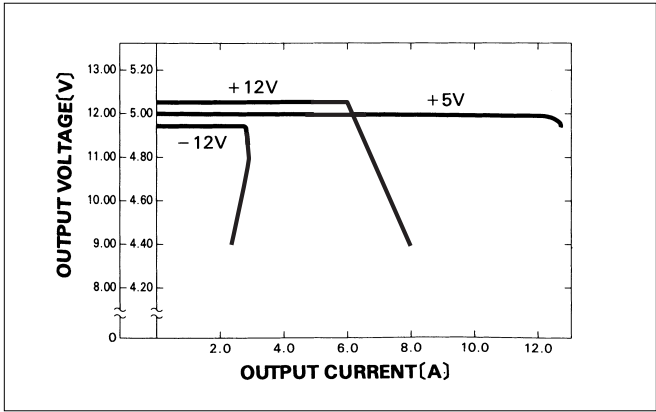

■ DERATING CURVE

