



Chipsmall Limited consists of a professional team with an average of over 10 year of expertise in the distribution of electronic components. Based in Hongkong, we have already established firm and mutual-benefit business relationships with customers from,Europe,America and south Asia,supplying obsolete and hard-to-find components to meet their specific needs.

With the principle of “Quality Parts,Customers Priority,Honest Operation,and Considerate Service”,our business mainly focus on the distribution of electronic components. Line cards we deal with include Microchip,ALPS,ROHM,Xilinx,Pulse,ON,Everlight and Freescale. Main products comprise IC,Modules,Potentiometer,IC Socket,Relay,Connector.Our parts cover such applications as commercial,industrial, and automotives areas.

We are looking forward to setting up business relationship with you and hope to provide you with the best service and solution. Let us make a better world for our industry!



Contact us

Tel: +86-755-8981 8866 Fax: +86-755-8427 6832

Email & Skype: info@chipsmall.com Web: www.chipsmall.com

Address: A1208, Overseas Decoration Building, #122 Zhenhua RD., Futian, Shenzhen, China





Driver or Pre-driver General Purpose Amplifier

The MMG30271B is a 1/2 W, Class AB, high gain amplifier designed as a driver or pre-driver for cellular base station Doherty amplifiers and general purpose small signal applications. Its versatile design enables operation from 900–4300 MHz, covering the 3G and 4G cellular bands.

Features

- P1dB: 26.9 dBm @ 2140 MHz
- Gain: 17.5 dB @ 2140 MHz
- Suitable for Doherty Amplifiers and BTS Transmitters
- 5 V Single Supply, 134 mA Quiescent Current
- SOT-89 Package
- 50 Ohm Operation with Minimal External Matching

MMG30271BT1

**900–4300 MHz, 17.5 dB @ 2140 MHz
 26.9 dBm
 BTS DRIVER AMPLIFIER**



SOT-89

Table 1. Load Pull Performance (1)

Characteristic	Symbol	900 MHz	1900 MHz	2140 MHz	2600 MHz	3500 MHz	4200 MHz	Unit
Maximum Available Gain	MAG	24.9	18.9	17.7	15.7	13.1	12.1	dB
P _{out} @ 1dB Compression	P1dB	29.0 (2)	27.3 (2)	27.2	27.3	27.4	27.1	dBm

Table 2. Maximum Ratings

Rating	Symbol	Value	Unit
Supply Voltage	V _{CC}	6	V
Supply Current	I _{CC}	240	mA
RF Input Power	P _{in}	23	dBm
Storage Temperature Range	T _{stg}	–65 to +150	°C
Junction Temperature	T _J	175	°C

Table 3. Thermal Characteristics

Characteristic	Symbol	Value (3)	Unit
Thermal Resistance, Junction to Case Case Temperature 65°C, 5 Vdc, 138 mA, no RF applied	R _{θJC}	33	°C/W

1. V_{CC} = 5 Vdc, T_A = 25°C, CW.

2. Maximum allowable current not to exceed 240 mA.

3. Refer to AN1955, *Thermal Measurement Methodology of RF Power Amplifiers*. Go to <http://www.nxp.com/RF> and search for AN1955.

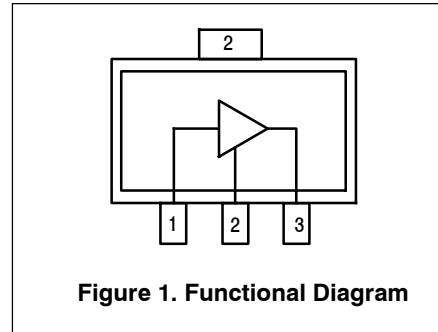

Table 4. Electrical Characteristics ($V_{CC} = 5$ Vdc, 2140 MHz, $T_A = 25^\circ\text{C}$, 50 ohm system, in Freescale Application Circuit)

Characteristic	Symbol	Min	Typ	Max	Unit
Small-Signal Gain (S21)	G_p	16.8	17.5	—	dB
Power Output @ 1dB Compression	P1dB	—	26.9	—	dBm
Input Return Loss (S11)	IRL	—	-9.2	—	dB
Output Return Loss (S22)	ORL	—	-11.4	—	dB
Supply Current	I_{CC}	107.5	134	142.5	mA
Supply Voltage	V_{CC}	—	5	—	V

Table 5. Functional Pin Description

Pin Number	Pin Function
1	RF_{in}
2	Ground
3	RF_{out}/DC Supply

**Table 6. ESD Protection Characteristics**

Test Methodology	Class
Human Body Model (per JESD 22-A114)	2
Machine Model (per EIA/JESD 22-A115)	A
Charge Device Model (per JESD 22-C101)	IV

Table 7. Moisture Sensitivity Level

Test Methodology	Rating	Package Peak Temperature	Unit
Per JESD22-A113, IPC/JEDEC J-STD-020	1	260	$^\circ\text{C}$

Table 8. Ordering Information

Device	Tape and Reel Information	Package
MMG30271BT1	T1 Suffix = 1,000 Units, 12 mm Tape Width, 7-inch Reel	SOT-89

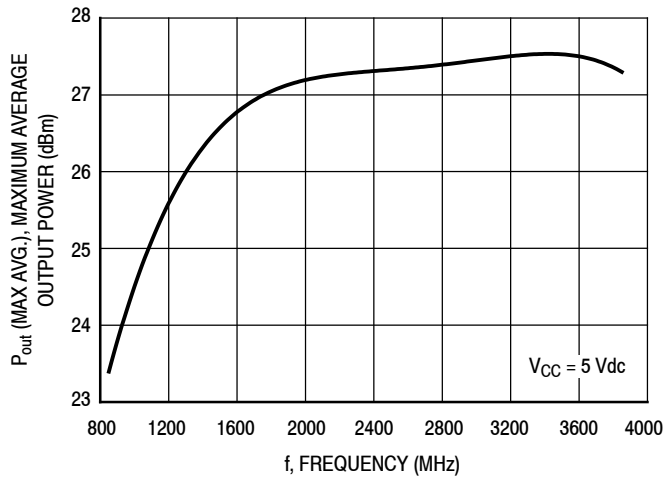

Note: Maximum allowable current not to exceed 240 mA.

Figure 2. Maximum Average Output Power versus Frequency

Table 9. ACPR versus Frequency (LTE 10 MHz, ACPR = -48 dBc)

f (MHz)	ACPR = -48 dBc		
	P _{out} (dBm)	Gain (dB)	I _{CC} (mA)
1900	16	19.2	147
2140	17.5	17.2	148
2600	17.5	16	144
3500	16.9	13.7	134
4250	17.6	11.5	138

50 OHM APPLICATION CIRCUIT: 2110–2170 MHz

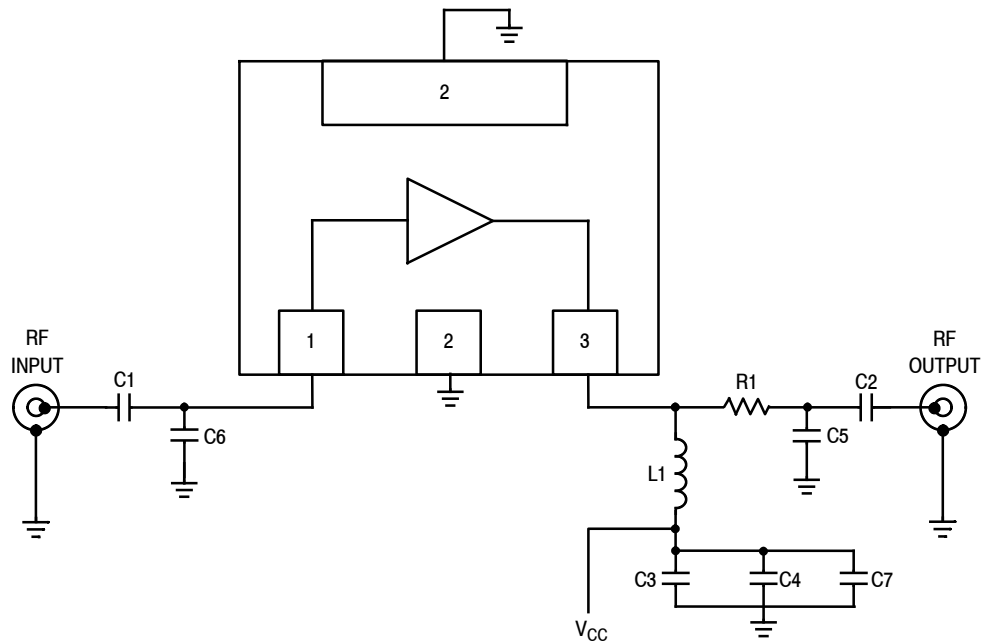
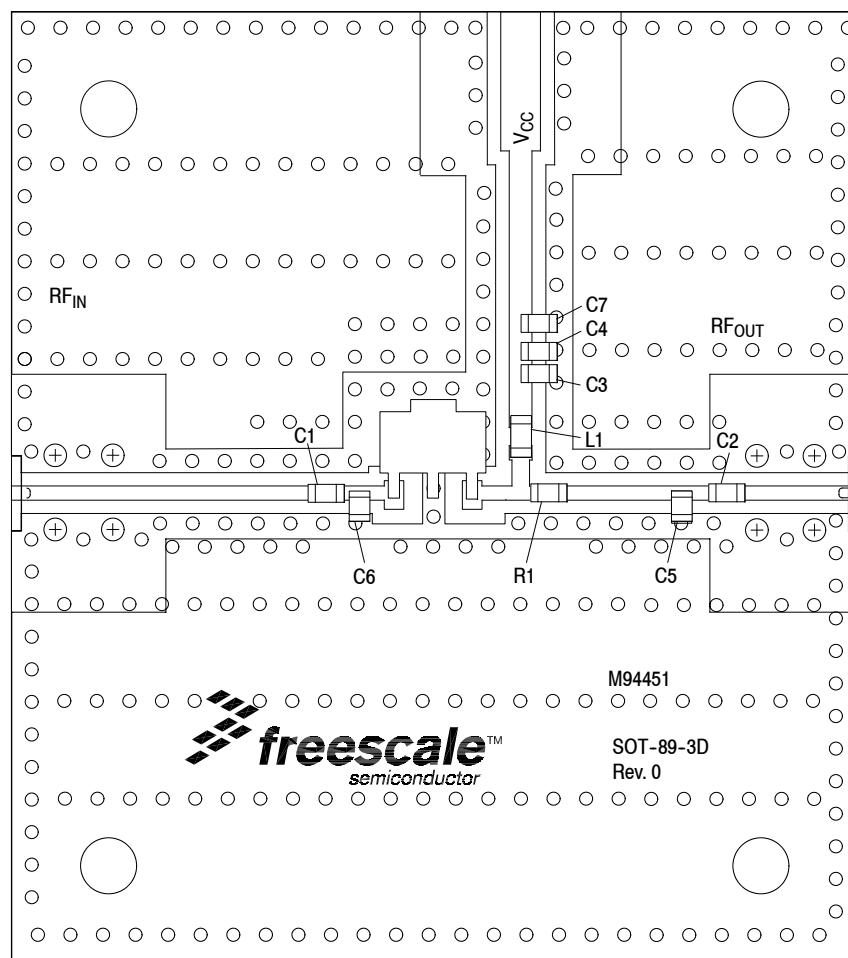

Figure 3. MMG30271BT1 Test Circuit Schematic

Table 10. MMG3027BT1 Test Circuit Component Designations and Values

Part	Description	Part Number	Manufacturer
C1	1.5 pF Chip Capacitor	GJM1555C1H1R5BB01	Murata
C2	100 pF Chip Capacitor	GRM1555C1H101JA01	Murata
C3	1000 pF Chip Capacitor	GCM155R71H102KA37	Murata
C4	0.01 μF Chip Capacitor	GRM188R72A103KA01	Murata
C5	1.3 pF Chip Capacitor	GJM1555C1H1R3BB01	Murata
C6	1.8 pF Chip Capacitor	GJM1555C1H1R8BB01	Murata
C7	1 μF Chip Capacitor	GRM155R61A105KE15	Murata
L1	3.9 nH Chip Inductor	LL1608-FSL3N9S	Toko
R1	0 Ω, 1 A Chip Resistor	RCO402JR-070RL	Yageo
PCB	Rogers R04350B, 0.010", ε _r = 3.66	M94451	MTL

50 OHM APPLICATION CIRCUIT: 2110–2170 MHz



PCB actual size: 1.3" × 1.46".

Figure 4. MMG30271BT1 Test Circuit Component Layout

Table 10. MMG30371BT1 Test Circuit Component Designations and Values

Part	Description	Part Number	Manufacturer
C1	1.5 pF Chip Capacitor	GJM1555C1H1R5BB01	Murata
C2	100 pF Chip Capacitor	GRM1555C1H101JA01	Murata
C3	1000 pF Chip Capacitor	GCM155R71H102KA37	Murata
C4	0.01 μF Chip Capacitor	GRM188R72A103KA01	Murata
C5	1.3 pF Chip Capacitor	GJM1555C1H1R3BB01	Murata
C6	1.8 pF Chip Capacitor	GJM1555C1H1R8BB01	Murata
C7	1 μF Chip Capacitor	GRM155R61A105KE15	Murata
L1	3.9 nH Chip Inductor	LL1608-FSL3N9S	Toko
R1	0 Ω, 1 A Chip Resistor	RCO402JR-070RL	Yageo
PCB	Rogers R04350B, 0.010", ε _r = 3.66	M94451	MTL

(Test Circuit Component Designations and Values table repeated for reference.)

50 OHM TYPICAL CHARACTERISTICS: 2110–2170 MHz

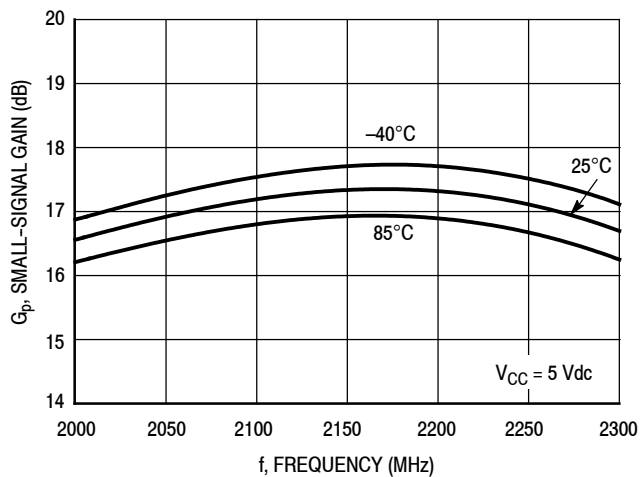

Figure 5. Small-Signal Gain (S21) versus Frequency and Temperature

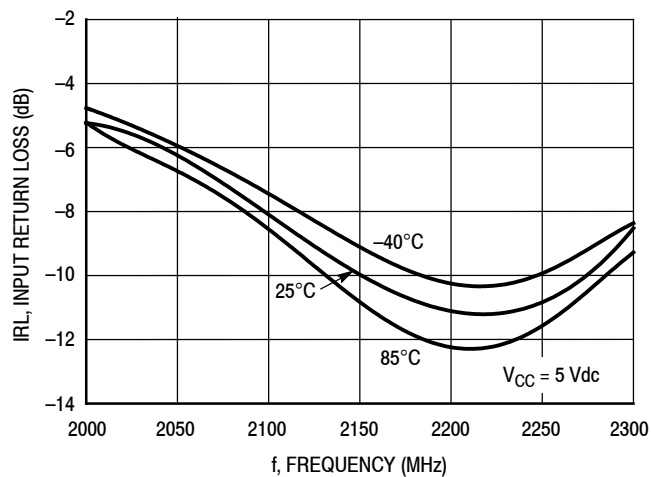

Figure 6. Input Return Loss (S11) versus Frequency and Temperature

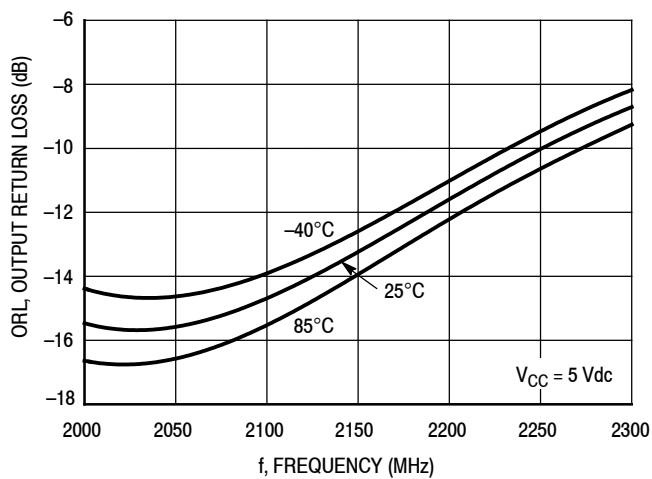

Figure 7. Output Return Loss (S22) versus Frequency and Temperature

50 OHM TYPICAL CHARACTERISTICS: 2110–2170 MHz

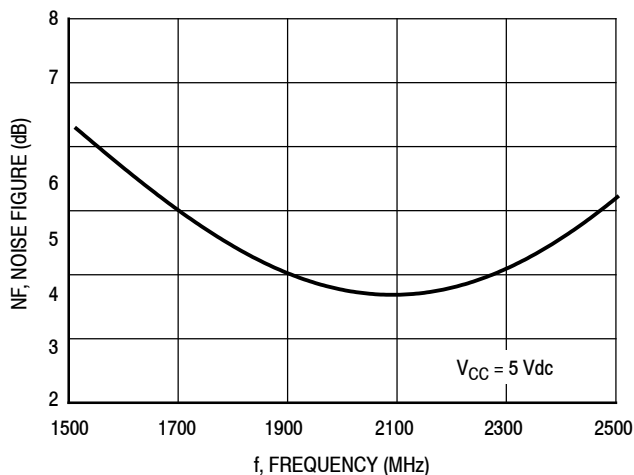

Figure 8. Noise Figure versus Frequency

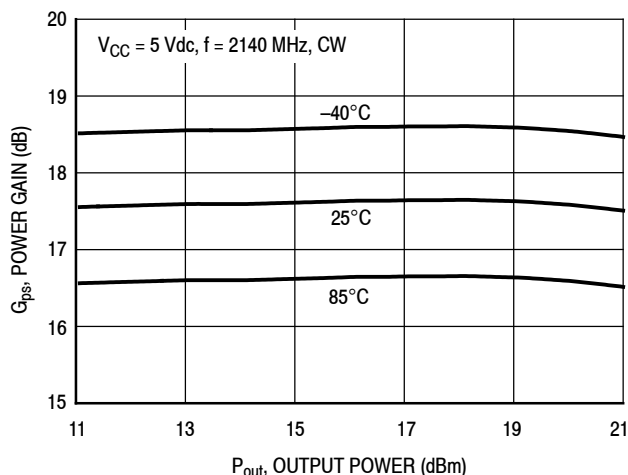

Figure 9. Power Gain versus Output Power and Temperature

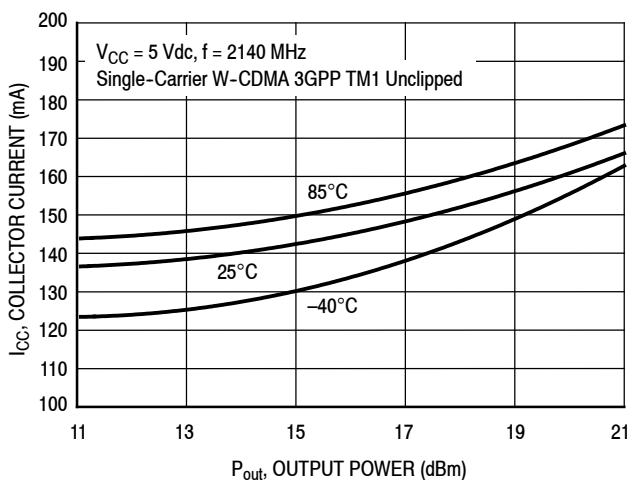

Figure 10. Collector Current versus Output Power and Temperature

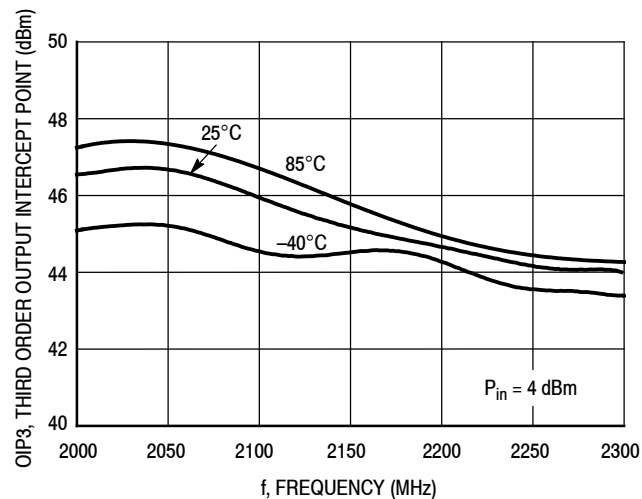

Figure 11. Third Order Output Intercept Point versus Frequency and Temperature

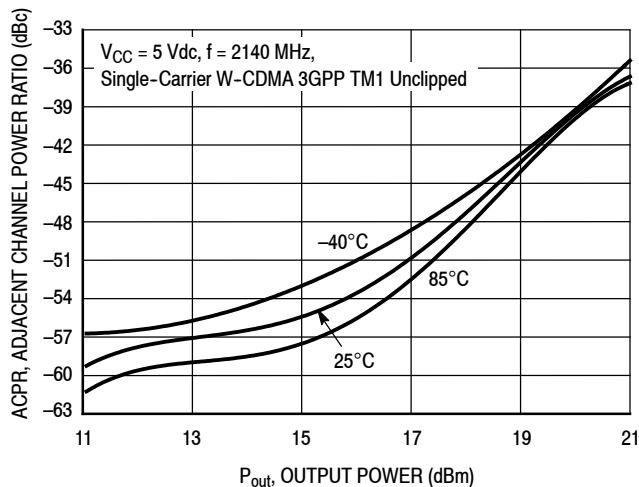

Figure 12. Single-Carrier W-CDMA Adjacent Channel Power Ratio versus Output Power and Temperature

50 OHM APPLICATION CIRCUIT: 1880–1920 MHz

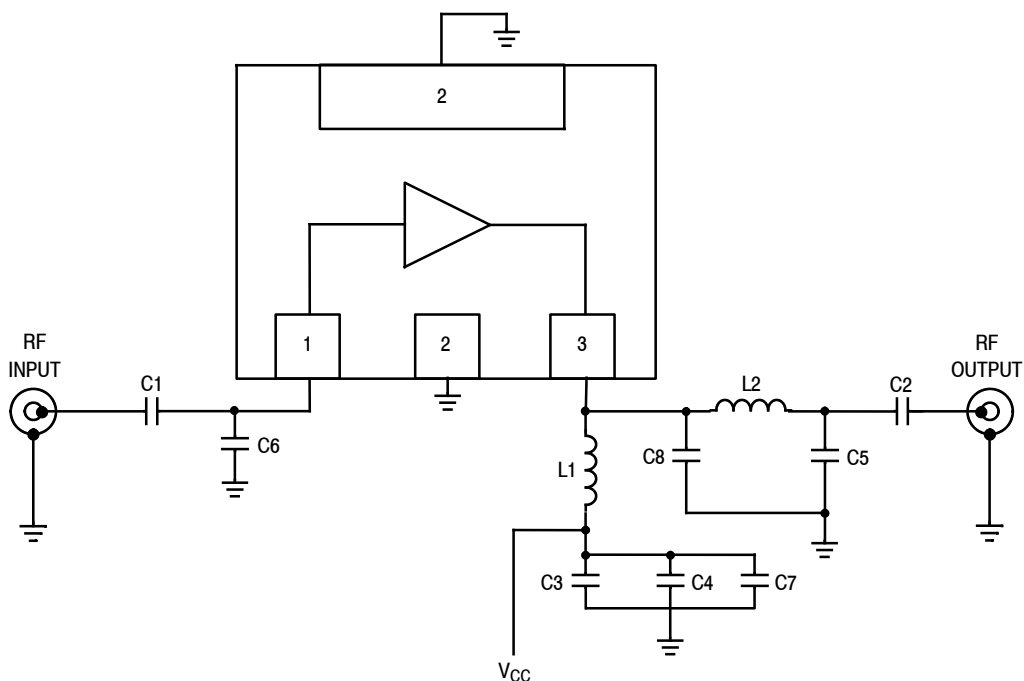
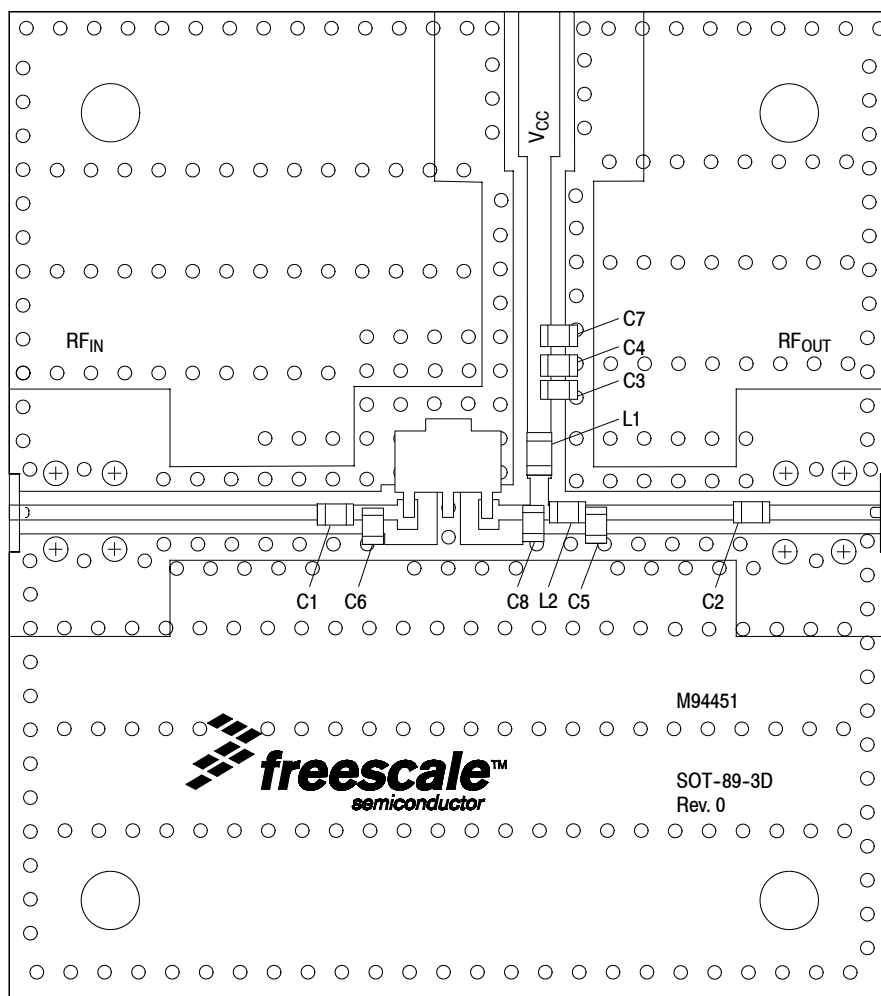

Figure 13. MMG30271BT1 Test Circuit Schematic

Table 11. MMG30271BT1 Test Circuit Component Designations and Values

Part	Description	Part Number	Manufacturer
C1	1.2 pF Chip Capacitor	GJM1555C1H1R2BB01	Murata
C2	100 pF Chip Capacitor	GRM1555C1H101JA01	Murata
C3	1000 pF Chip Capacitor	GCM155R71H102KA37	Murata
C4	0.01 μ F Chip Capacitor	GRM188R72A103KA01	Murata
C5	2.2 pF Chip Capacitor	GJM1555C1H2R2BB01	Murata
C6	3.0 pF Chip Capacitor	GJM1555C1H3R0BB01	Murata
C7	1 μ F Chip Capacitor	GRM155R61A105KE15	Murata
C8	2.4 pF Chip Capacitor	GJM1555C1H2R4BB01	Murata
L1	10 nH Chip Inductor	LL1608-FH10NJ	Toko
L2	1.9 nH Chip Inductor	0402CS-1N9XJLW	Coilcraft
PCB	Rogers R04350B, 0.010", $\epsilon_r = 3.66$	M94451	MTL

50 OHM APPLICATION CIRCUIT: 1880–1920 MHz



PCB actual size: 1.3" × 1.46".

Figure 14. MMG30271BT1 Test Circuit Component Layout

Table 11. MMG30271BT1 Test Circuit Component Designations and Values

Part	Description	Part Number	Manufacturer
C1	1.2 pF Chip Capacitor	GJM1555C1H1R2BB01	Murata
C2	100 pF Chip Capacitor	GRM1555C1H101JA01	Murata
C3	1000 pF Chip Capacitor	GCM155R71H102KA37	Murata
C4	0.01 μF Chip Capacitor	GRM188R72A103KA01	Murata
C5	2.2 pF Chip Capacitor	GJM1555C1H2R2BB01	Murata
C6	3.0 pF Chip Capacitor	GJM1555C1H3R0BB01	Murata
C7	1 μF Chip Capacitor	GRM155R61A105KE15	Murata
C8	2.4 pF Chip Capacitor	GJM1555C1H2R4BB01	Murata
L1	10 nH Chip Inductor	LL1608-FH10NJ	Toko
L2	1.9 nH Chip Inductor	0402CS-1N9XJLW	Coilcraft
PCB	Rogers R04350B, 0.010", $\epsilon_r = 3.66$	M94451	MTL

(Test Circuit Component Designations and Values table repeated for reference.)

50 OHM TYPICAL CHARACTERISTICS: 1880–1920 MHz

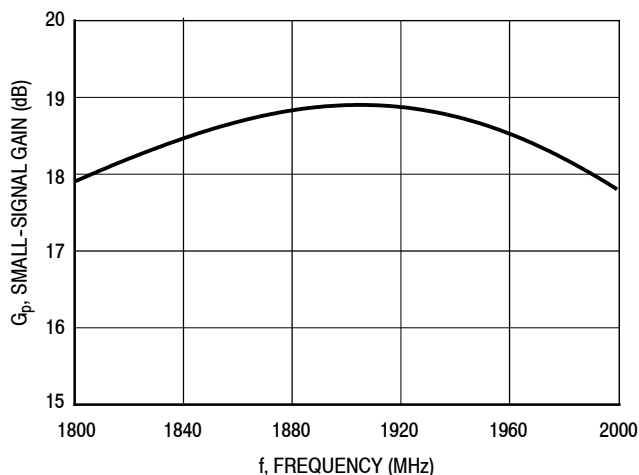

Figure 15. Small-Signal Gain (S21) versus Frequency

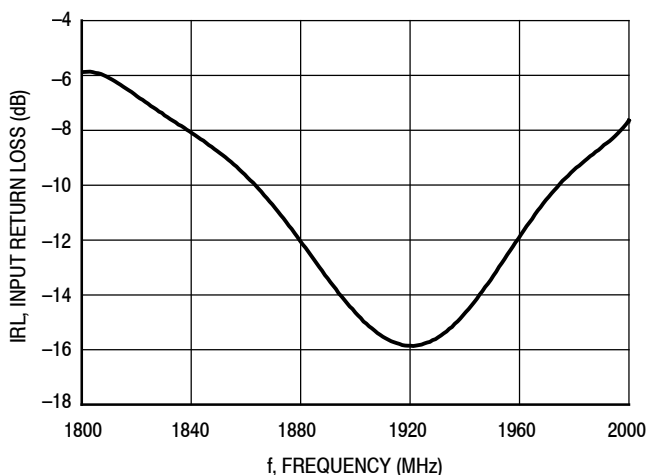

Figure 16. Input Return Loss (S11) versus Frequency

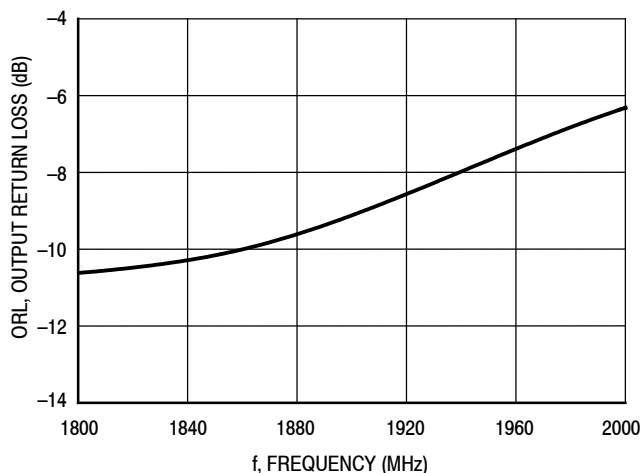
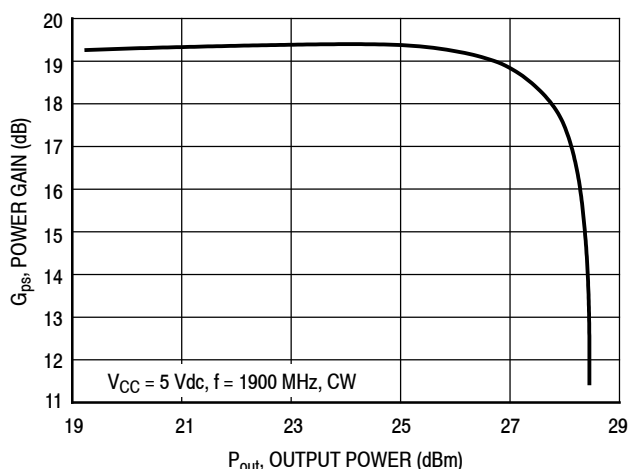

Figure 17. Output Return Loss (S22) versus Frequency



Note: Maximum allowable current not to exceed 240 mA.

Figure 18. Power Gain versus Output Power

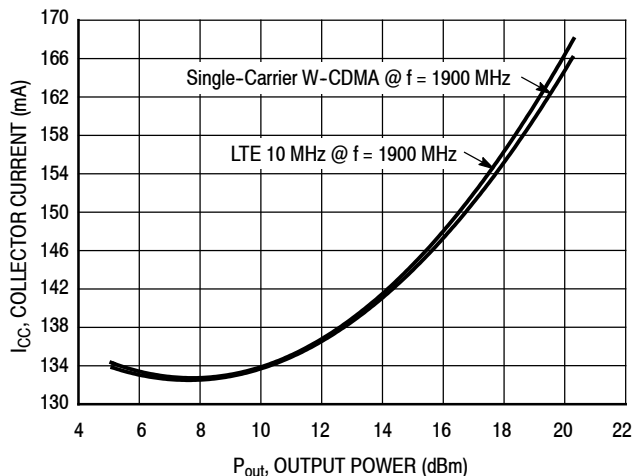

Figure 19. Collector Current versus Output Power

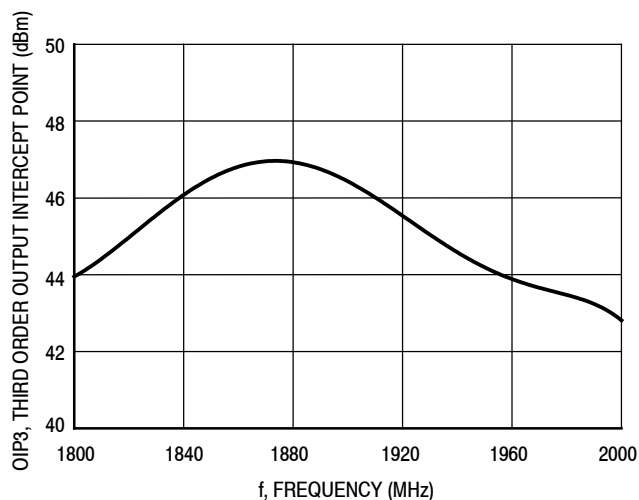

Figure 20. Third Order Output Intercept Point versus Frequency

50 OHM TYPICAL CHARACTERISTICS: 1880–1920 MHz

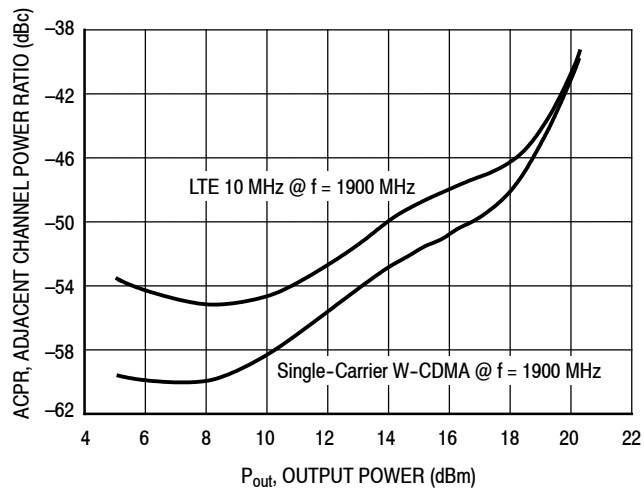

Figure 21. Adjacent Channel Power Ratio versus Output Power

50 OHM APPLICATION CIRCUIT: 2496–2690 MHz

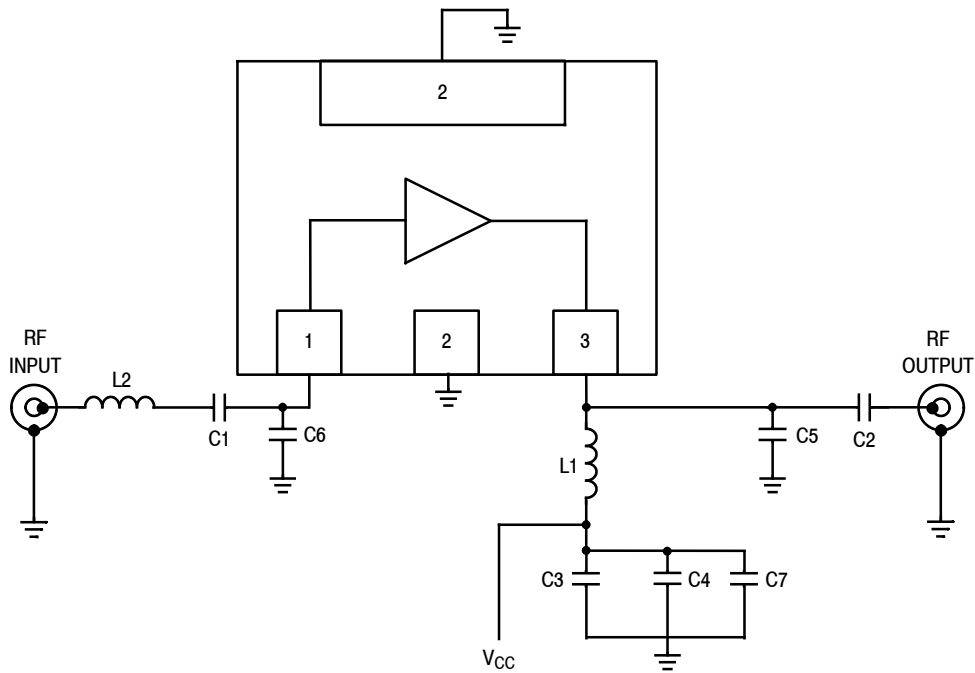
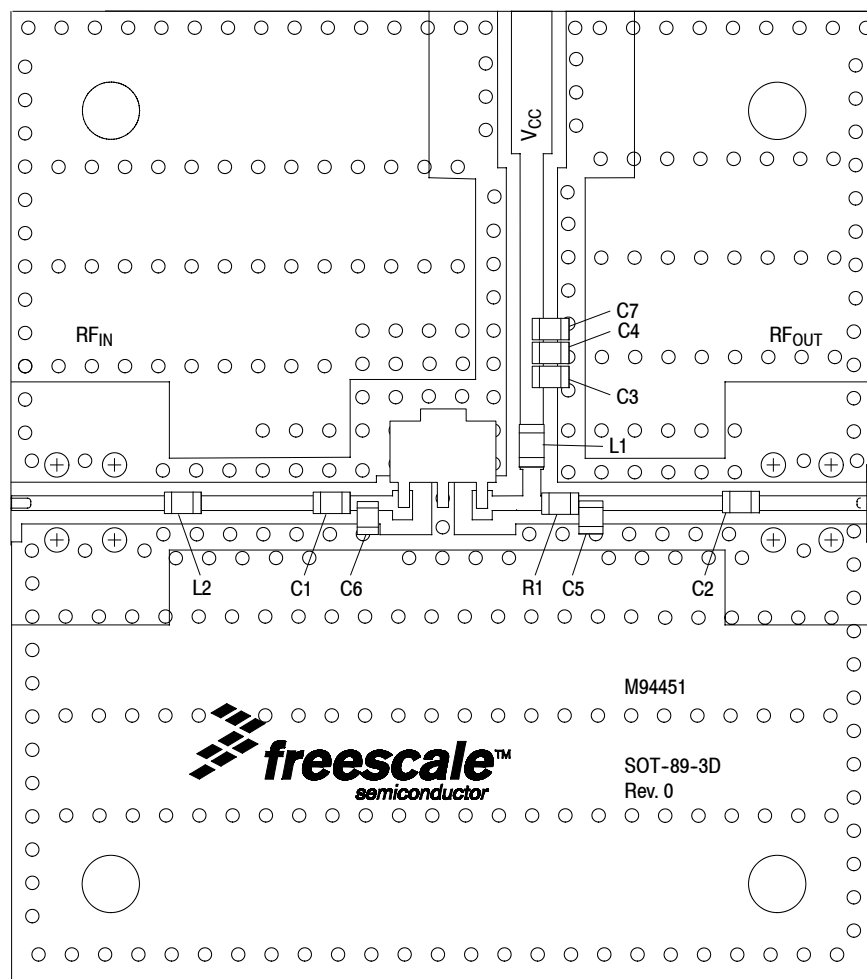

Figure 22. MMG30271BT1 Test Circuit Schematic

Table 12. MMG30271BT1 Test Circuit Component Designations and Values

Part	Description	Part Number	Manufacturer
C1, C2	100 pF Chip Capacitors	GRM1555C1H101JA01	Murata
C3	220 pF Chip Capacitor	GRM1555C1H221JA01	Murata
C4	2200 pF Chip Capacitor	GRM1555C1H222JA01	Murata
C5	1.8 pF Chip Capacitor	GJM1555C1H1R8BB01	Murata
C6	1.6 pF Chip Capacitor	GJM1555C1H1R6BB01	Murata
C7	1 μ F Chip Capacitor	GRM155R61A105KE15	Murata
L1	10 nH Chip Inductor	0603HC-10NXJLC	Coilcraft
L2	3.3 nH Chip Inductor	0402CS-3N3X	Coilcraft
PCB	Rogers R04350B, 0.010", $\epsilon_r = 3.66$	M94451	MTL

50 OHM APPLICATION CIRCUIT: 2496–2690 MHz



PCB actual size: 1.3" × 1.46".

Figure 23. MMG30271BT1 Test Circuit Component Layout

Table 12. MMG30271BT1 Test Circuit Component Designations and Values

Part	Description	Part Number	Manufacturer
C1, C2	100 pF Chip Capacitors	GRM1555C1H101JA01	Murata
C3	220 pF Chip Capacitor	GRM1555C1H221JA01	Murata
C4	2200 pF Chip Capacitor	GRM1555C1H222JA01	Murata
C5	1.8 pF Chip Capacitor	GJM1555C1H1R8BB01	Murata
C6	1.6 pF Chip Capacitor	GJM1555C1H1R6BB01	Murata
C7	1 μ F Chip Capacitor	GRM155R61A105KE15	Murata
L1	10 nH Chip Inductor	0603HC-10NXJLC	Coilcraft
L2	3.3 nH Chip Inductor	0402CS-3N3X	Coilcraft
R1	0 Ω , 1 A Chip Resistor	RC0402JR-070RL	Yageo
PCB	Rogers R04350B, 0.010", $\epsilon_r = 3.66$	M94451	MTL

(Test Circuit Component Designations and Values table repeated for reference.)

50 OHM TYPICAL CHARACTERISTICS: 2496–2690 MHz

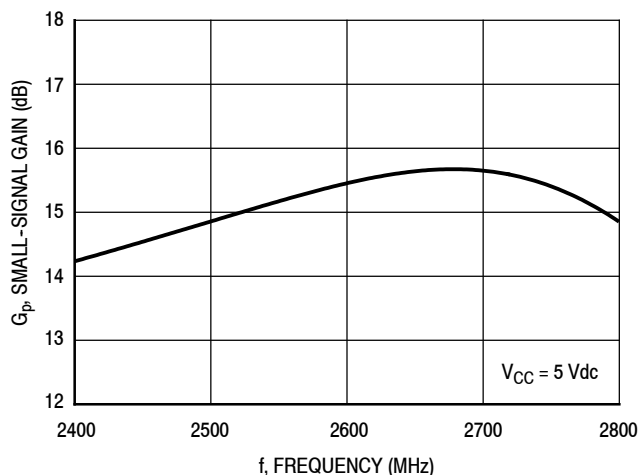

Figure 24. Small-Signal Gain (S21) versus Frequency

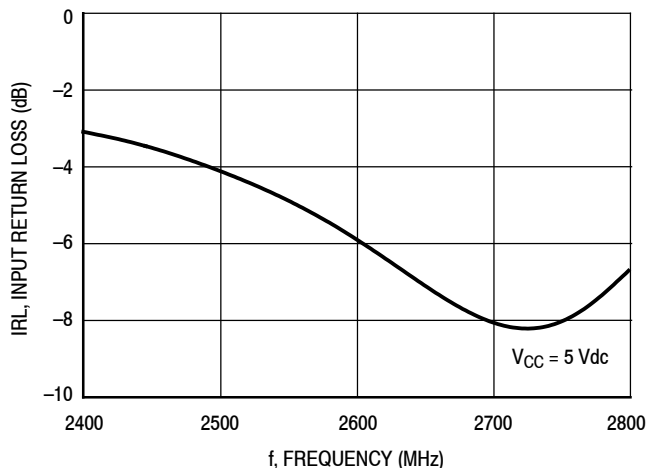

Figure 25. Input Return Loss (S11) versus Frequency

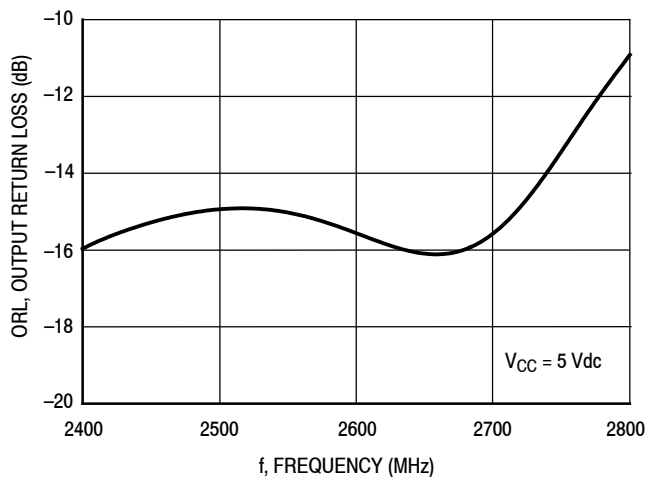

Figure 26. Output Return Loss (S22) versus Frequency

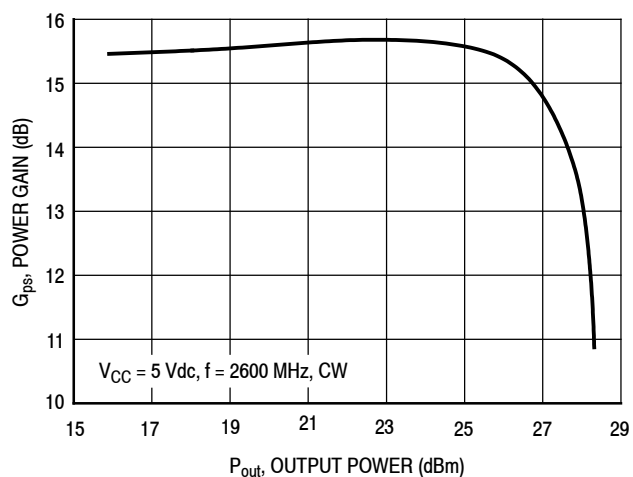

Figure 27. Power Gain versus Output Power

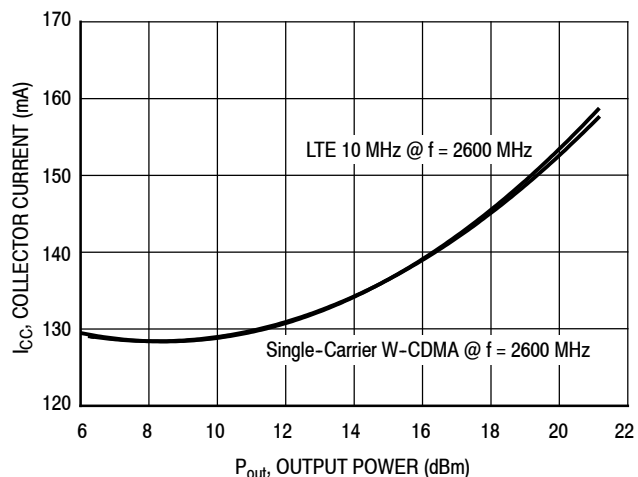

Figure 28. Collector Current versus Output Power

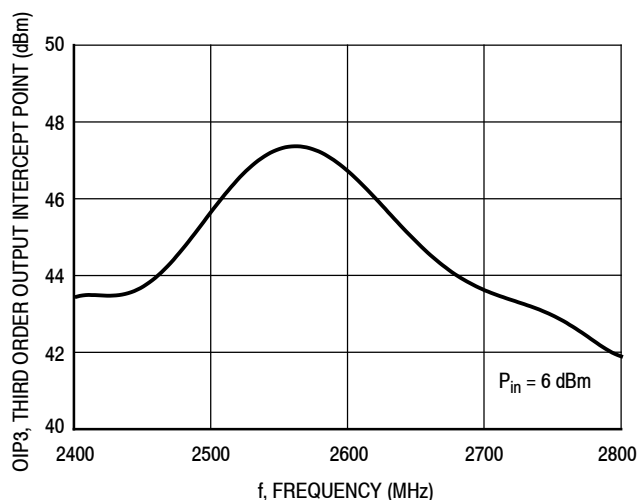

Figure 29. Third Order Output Intercept Point versus Frequency

50 OHM TYPICAL CHARACTERISTICS: 2496–2690 MHz

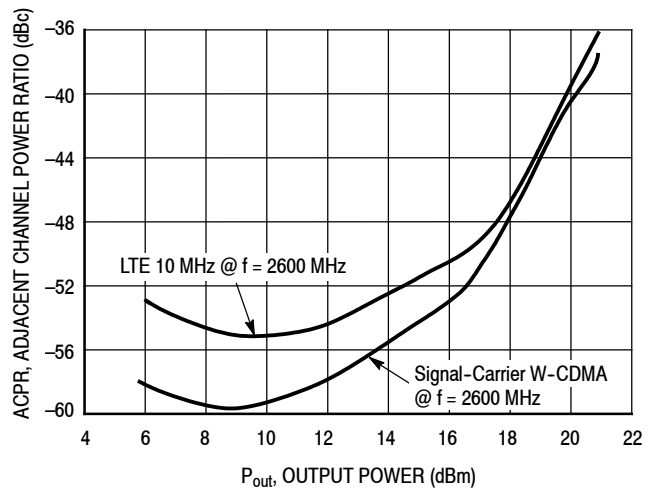

Figure 30. Adjacent Channel Power Ratio versus Output Power

50 OHM APPLICATION CIRCUIT: 3400–3600 MHz

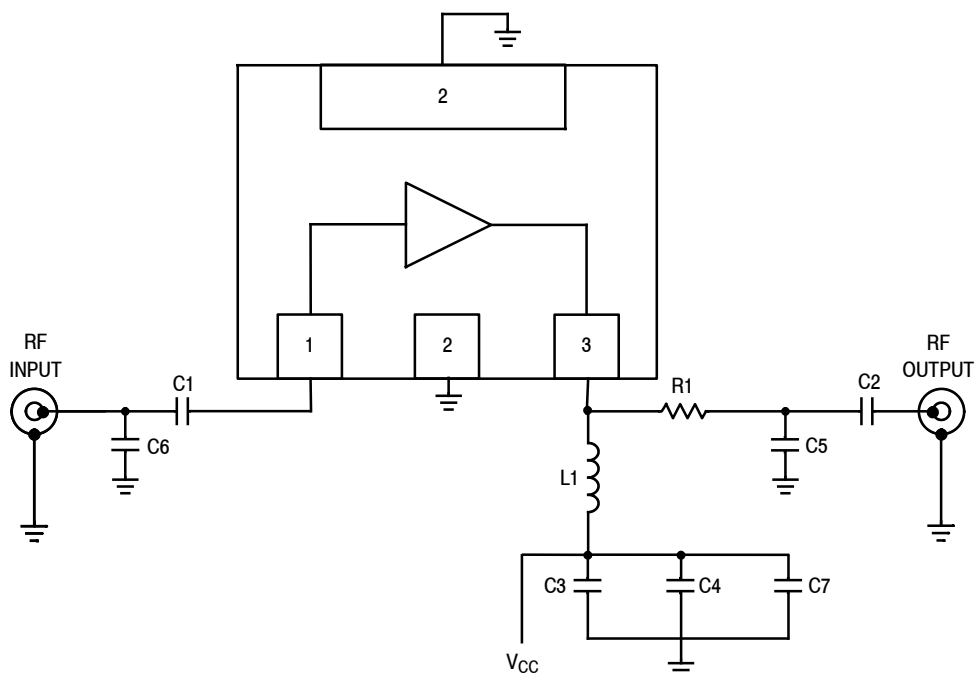
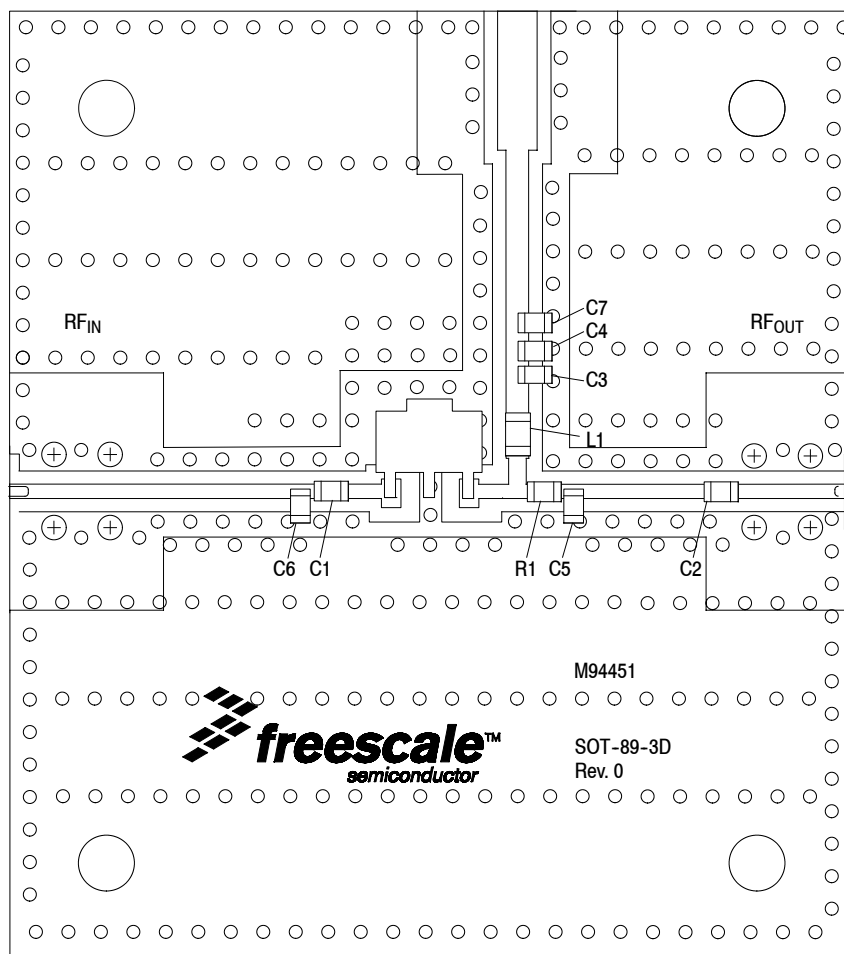

Figure 31. MMG30271BT1 Test Circuit Schematic

Table 13. MMG30271BT1 Test Circuit Component Designations and Values

Part	Description	Part Number	Manufacturer
C1	0.8 pF Chip Capacitor	GJM1555C1H0R8BB01	Murata
C2	100 pF Chip Capacitor	GRM1555C1H101JA01	Murata
C3	1000 pF Chip Capacitor	GCM155R71H102KA37	Murata
C4	0.01 μ F Chip Capacitor	GRM188R72A103KA01	Murata
C5	1.1 pF Chip Capacitor	GJM1555C1H1R1BB01	Murata
C6	1.1 pF Chip Capacitor	GJM1555C1H1R1BB01	Murata
C7	1 μ F Chip Capacitor	GRM155R61A105KE15	Murata
L1	10 nH Chip Inductor	LL1608-FH10NJ	Toko
R1	0 Ω , 1 A Chip Resistor	RC0402JR-070RL	Yageo
PCB	Rogers R04350B, 0.010", $\epsilon_r = 3.66$	M94451	MTL

50 OHM APPLICATION CIRCUIT: 3400–3600 MHz



PCB actual size: 1.3" × 1.46".

Figure 32. MMG30271BT1 Test Circuit Component Layout

Table 13. MMG30271BT1 Test Circuit Component Designations and Values

Part	Description	Part Number	Manufacturer
C1	0.8 pF Chip Capacitor	GJM1555C1H0R8BB01	Murata
C2	100 pF Chip Capacitor	GRM1555C1H101JA01	Murata
C3	1000 pF Chip Capacitor	GCM155R71H102KA37	Murata
C4	0.01 μF Chip Capacitor	GRM188R72A103KA01	Murata
C5	1.1 pF Chip Capacitor	GJM1555C1H1R1BB01	Murata
C6	1.1 pF Chip Capacitor	GJM1555C1H1R1BB01	Murata
C7	1 μF Chip Capacitor	GRM155R61A105KE15	Murata
L1	10 nH Chip Inductor	LL1608-FH10NJ	Toko
R1	0 Ω, 1 A Chip Resistor	RC0402JR-070RL	Yageo
PCB	Rogers R04350B, 0.010", ε _r = 3.66	M94451	MTL

(Test Circuit Component Designations and Values table repeated for reference.)

50 OHM TYPICAL CHARACTERISTICS: 3400–3600 MHz

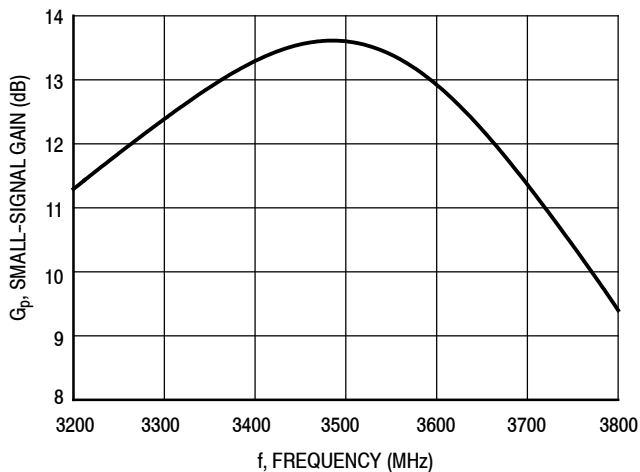

Figure 33. Small-Signal Gain (S21) versus Frequency

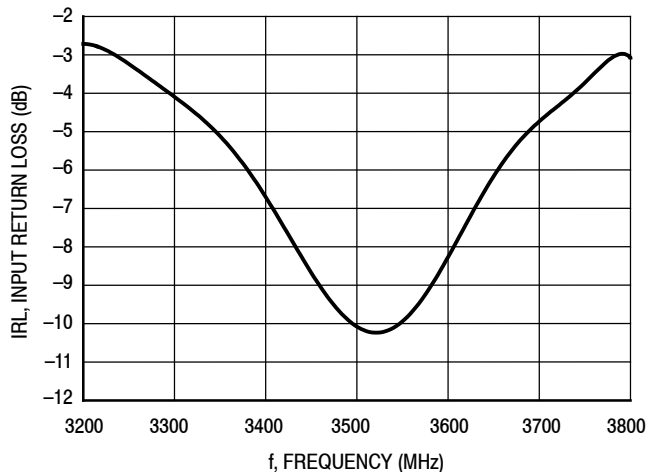

Figure 34. Input Return Loss (S11) versus Frequency

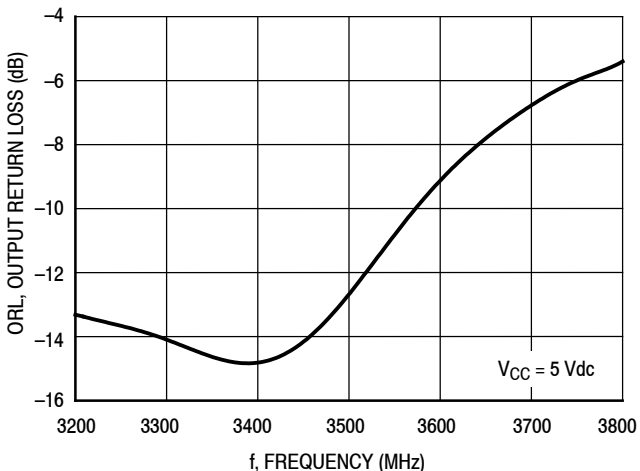

Figure 35. Output Return Loss (S22) versus Frequency

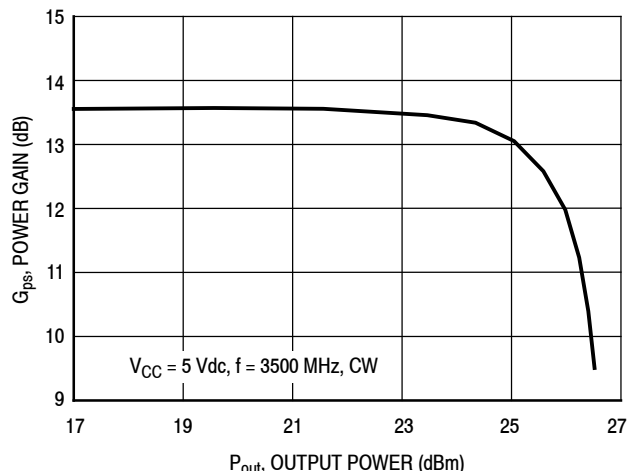

Figure 36. Power Gain versus Output Power

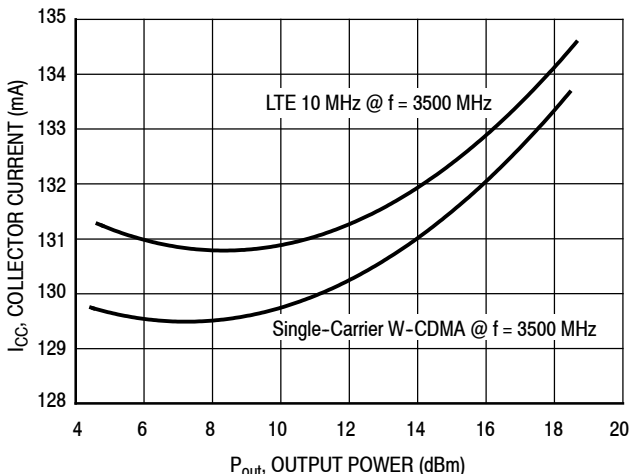

Figure 37. Collector Current versus Output Power

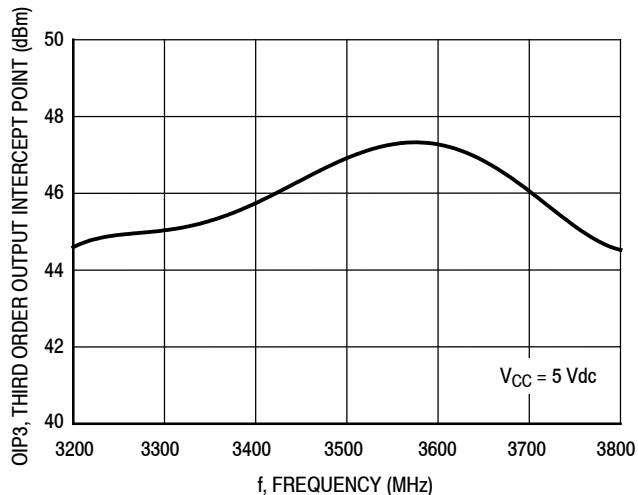

Figure 38. Third Order Output Intercept Point versus Frequency

50 OHM TYPICAL CHARACTERISTICS: 3400–3600 MHz

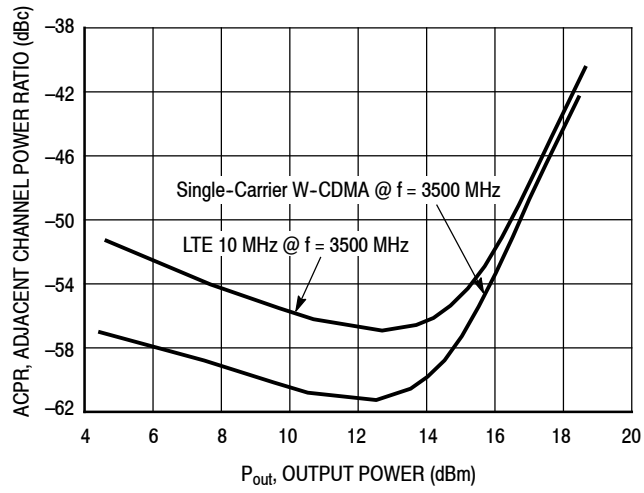

Figure 39. Adjacent Channel Power Ratio versus Output Power

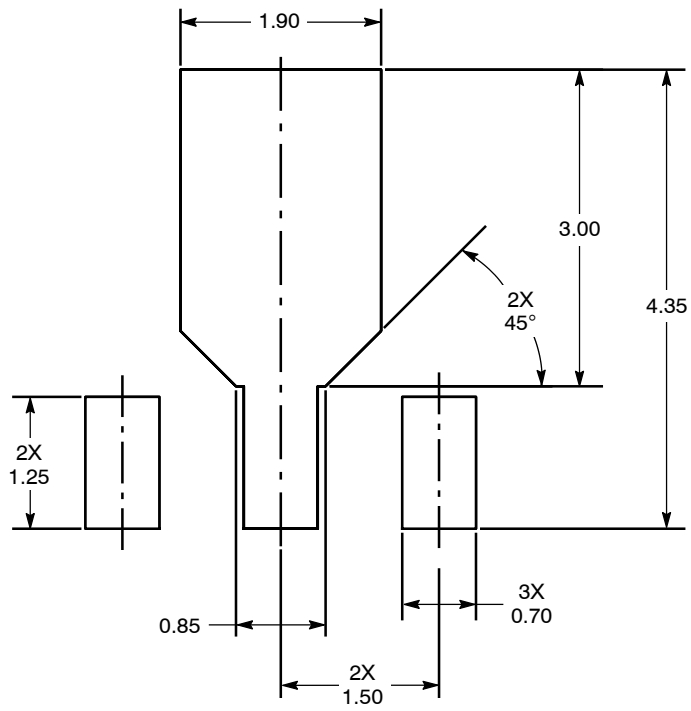

Figure 40. PCB Pad Layout for SOT-89A

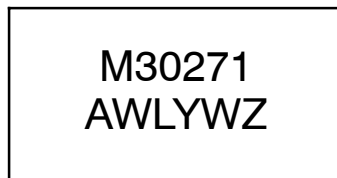
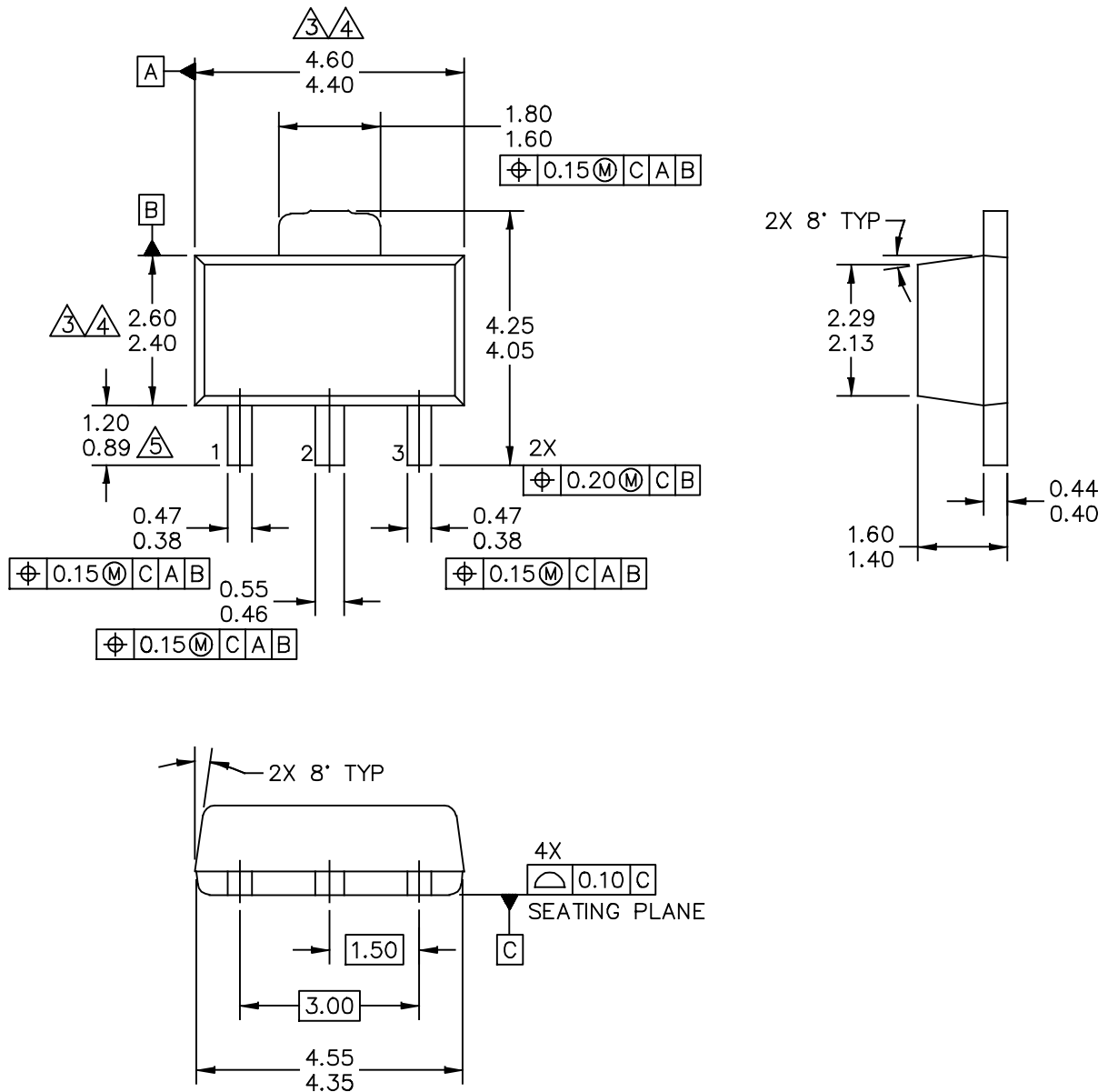
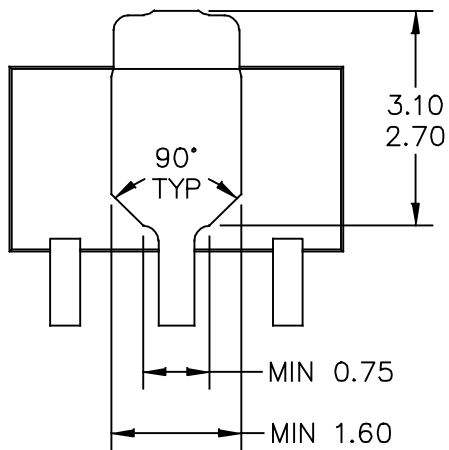

Figure 41. Product Marking

PACKAGE DIMENSIONS



© FREESCALE SEMICONDUCTOR, INC. ALL RIGHTS RESERVED.	MECHANICAL OUTLINE	PRINT VERSION NOT TO SCALE	
TITLE: SOT-89A, 3 LEAD, 4.5 X 2.5 PKG, 1.5 MM PITCH		DOCUMENT NO: 98ASA00241D	REV: 0
		CASE NUMBER: 2142-01	15 JUL 2010
		STANDARD: NON-JEDEC	



BOTTOM VIEW

© FREESCALE SEMICONDUCTOR, INC. ALL RIGHTS RESERVED.	MECHANICAL OUTLINE	PRINT VERSION NOT TO SCALE	
TITLE: SOT-89A, 3 LEAD, 4.5 X 2.5 PKG, 1.5 MM PITCH	DOCUMENT NO: 98ASA00241D	REV: 0	
	CASE NUMBER: 2142-01	15 JUL 2010	
	STANDARD: NON-JEDEC		

NOTES:

1. DIMENSIONING AND TOLERANCING PER ASME Y14.5M – 1994.

2. ALL DIMENSIONS ARE IN MILLIMETERS.

3. DIMENSIONS DOES NOT INCLUDE MOLD FLASH. PROTRUSIONS OR GATE BURRS. MOLD FLASH, PROTRUSIONS OR GATE BURRS SHALL NOT EXCEED 0.5 MM PER END. DIMENSION DOES NOT INCLUDE INTERLEAD FLASH OR PROTRUSION. INTERLEAD FLASH OR PROTRUSION SHALL NOT EXCEED 0.5 MM PER SIDE.

4. DIMENSION ARE DETERMINED AT THE OUTMOST EXTREMES OF THE PLASTIC BODY EXCLUSIVE OF MOLD FLASH, TIE BAR BURRS, GATE BURRS AND INTERLEAD FLASH, BUT INCLUDING ANY MISMATCH BETWEEN THE TOP AND BOTTOM OF THE PLASTIC BODY.

5. TERMINAL NUMBERS ARE SHOWN FOR REFERENCE ONLY.

© FREESCALE SEMICONDUCTOR, INC. ALL RIGHTS RESERVED.	MECHANICAL OUTLINE	PRINT VERSION NOT TO SCALE	
TITLE: SOT-89A, 3 LEAD, 4.5 X 2.5 PKG, 1.5 MM PITCH	DOCUMENT NO: 98ASA00241D	REV: 0	
	CASE NUMBER: 2142-01	15 JUL 2010	
	STANDARD: NON-JEDEC		

PRODUCT DOCUMENTATION, SOFTWARE AND TOOLS

Refer to the following resources to aid your design process.

Application Notes

- AN1955: Thermal Measurement Methodology of RF Power Amplifiers

Software

- .s2p File

Development Tools

- Printed Circuit Boards

To Download Resources Specific to a Given Part Number:

2. Go to <http://www.nxp.com/RF>
3. Search by part number
4. Click part number link
5. Choose the desired resource from the drop down menu

FAILURE ANALYSIS

At this time, because of the physical characteristics of the part, failure analysis is limited to electrical signature analysis. In cases where Freescale is contractually obligated to perform failure analysis (FA) services, full FA may be performed by third party vendors with moderate success. For updates contact your local Freescale Sales Office.

REVISION HISTORY

The following table summarizes revisions to this document.

Revision	Date	Description
0	Mar. 2016	• Initial Release of Data Sheet

How to Reach Us:

Home Page:
freescale.com

Web Support:
freescale.com/support

Information in this document is provided solely to enable system and software implementers to use Freescale products. There are no express or implied copyright licenses granted hereunder to design or fabricate any integrated circuits based on the information in this document.

Freescale reserves the right to make changes without further notice to any products herein. Freescale makes no warranty, representation, or guarantee regarding the suitability of its products for any particular purpose, nor does Freescale assume any liability arising out of the application or use of any product or circuit, and specifically disclaims any and all liability, including without limitation consequential or incidental damages. "Typical" parameters that may be provided in Freescale data sheets and/or specifications can and do vary in different applications, and actual performance may vary over time. All operating parameters, including "typicals," must be validated for each customer application by customer's technical experts. Freescale does not convey any license under its patent rights nor the rights of others. Freescale sells products pursuant to standard terms and conditions of sale, which can be found at the following address: freescale.com/SalesTermsandConditions.

Freescale and the Freescale logo are trademarks of Freescale Semiconductor, Inc., Reg. U.S. Pat. & Tm. Off. All other product or service names are the property of their respective owners.

© 2016 Freescale Semiconductor, Inc.

