



Chipsmall Limited consists of a professional team with an average of over 10 year of expertise in the distribution of electronic components. Based in Hongkong, we have already established firm and mutual-benefit business relationships with customers from,Europe,America and south Asia,supplying obsolete and hard-to-find components to meet their specific needs.

With the principle of "Quality Parts,Customers Priority,Honest Operation,and Considerate Service",our business mainly focus on the distribution of electronic components. Line cards we deal with include Microchip,ALPS,ROHM,Xilinx,Pulse,ON,Everlight and Freescale. Main products comprise IC,Modules,Potentiometer,IC Socket,Relay,Connector.Our parts cover such applications as commercial,industrial, and automotives areas.

We are looking forward to setting up business relationship with you and hope to provide you with the best service and solution. Let us make a better world for our industry!



Contact us

Tel: +86-755-8981 8866 Fax: +86-755-8427 6832

Email & Skype: info@chipsmall.com Web: www.chipsmall.com

Address: A1208, Overseas Decoration Building, #122 Zhenhua RD., Futian, Shenzhen, China



MMJT9410

Preferred Device

Bipolar Power Transistors

NPN Silicon

Features

- Collector –Emitter Sustaining Voltage –
 $V_{CE(sus)} = 30 \text{ Vdc (Min) @ } I_C = 10 \text{ mAdc}$
- High DC Current Gain –
 $h_{FE} = 85 \text{ (Min) @ } I_C = 0.8 \text{ Adc}$
 $= 60 \text{ (Min) @ } I_C = 3.0 \text{ Adc}$
- Low Collector –Emitter Saturation Voltage –
 $V_{CE(sat)} = 0.2 \text{ Vdc (Max) @ } I_C = 1.2 \text{ Adc}$
 $= 0.45 \text{ Vdc (Max) @ } I_C = 3.0 \text{ Adc}$
- SOT–223 Surface Mount Packaging
- Epoxy Meets UL 94 V–0 @ 0.125 in
- ESD Ratings: Human Body Model, 3B; > 8000 V
Machine Model, C; > 400 V
- Pb–Free Package is Available

MAXIMUM RATINGS

Rating	Symbol	Value	Unit
Collector –Emitter Voltage	V_{CEO}	30	Vdc
Collector –Base Voltage	V_{CB}	45	Vdc
Emitter –Base Voltage	V_{EB}	± 6.0	Vdc
Base Current – Continuous	I_B	1.0	Adc
Collector Current – Continuous – Peak	I_C	3.0 5.0	Adc
Total Power Dissipation @ $T_C = 25^\circ\text{C}$ Derate above 25°C Total P_D @ $T_A = 25^\circ\text{C}$ mounted on 1" sq. (645 sq. mm) Collector pad on FR–4 bd material Total P_D @ $T_A = 25^\circ\text{C}$ mounted on 0.012" sq. (7.6 sq. mm) Collector pad on FR–4 bd material	P_D	3.0 24 1.7 0.75	W mW/°C W
Operating and Storage Junction Temperature Range	T_J, T_{stg}	–55 to +150	°C

THERMAL CHARACTERISTICS

Characteristic	Symbol	Max	Unit
Thermal Resistance, Junction–to–Case	$R_{\theta JC}$	42	°C/W
Thermal Resistance, Junction–to–Ambient on 1" sq. (645 sq. mm) Collector pad on FR–4 bd material	$R_{\theta JA}$	75	°C/W
Thermal Resistance, Junction–to–Ambient on 0.012" sq. (7.6 sq. mm) Collector pad on FR–4 bd material	$R_{\theta JA}$	165	°C/W
Maximum Lead Temperature for Soldering Purposes, 1/8" from case for 5 seconds	T_L	260	°C

Stresses exceeding Maximum Ratings may damage the device. Maximum Ratings are stress ratings only. Functional operation above the Recommended Operating Conditions is not implied. Extended exposure to stresses above the Recommended Operating Conditions may affect device reliability.



ON Semiconductor®

<http://onsemi.com>

POWER BJT
 $I_C = 3.0 \text{ AMPERES}$
 $BV_{CEO} = 30 \text{ VOLTS}$
 $V_{CE(sat)} = 0.2 \text{ VOLTS}$

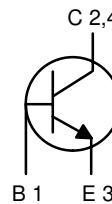

Schematic

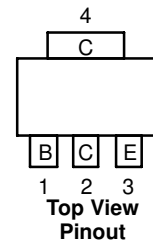

Top View Pinout

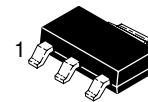

SOT–223 (TO–261)
CASE 318E
STYLE 1

MARKING DIAGRAM

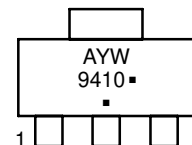

A = Assembly Location
Y = Year
W = Work Week
9410 = Device Code
▪ = Pb–Free Package

(Note: Microdot may be in either location)

ORDERING INFORMATION

Device	Package	Shipping†
MMJT9410	SOT–223	1000 / Tape & Reel
MMJT9410G	SOT–223 (Pb–Free)	1000 / Tape & Reel

†For information on tape and reel specifications, including part orientation and tape sizes, please refer to our Tape and Reel Packaging Specifications Brochure, BRD8011/D.

Preferred devices are recommended choices for future use and best overall value.

MMJT9410

ELECTRICAL CHARACTERISTICS (T_C = 25°C unless otherwise noted)

Characteristic	Symbol	Min	Typ	Max	Unit
----------------	--------	-----	-----	-----	------

OFF CHARACTERISTICS

Collector–Emitter Sustaining Voltage (I _C = 10 mAdc, I _B = 0 Adc)	V _{CEO(sus)}	30	–	–	Vdc
Emitter–Base Voltage (I _E = 50 μAdc, I _C = 0 Adc)	V _{EBO}	6.0	–	–	Vdc
Collector Cutoff Current (V _{CE} = 25 Vdc, R _{BE} = 200 Ω) (V _{CE} = 25 Vdc, R _{BE} = 200 Ω, T _J = 125°C)	I _{CER}	–	–	20 200	μAdc
Emitter Cutoff Current (V _{BE} = 5.0 Vdc)	I _{EBO}	–	–	10	μAdc

ON CHARACTERISTICS (Note 1)

Collector–Emitter Saturation Voltage (I _C = 0.8 Adc, I _B = 20 mAdc) (I _C = 1.2 Adc, I _B = 20 mAdc) (I _C = 3.0 Adc, I _B = 0.3 Adc)	V _{CE(sat)}	–	0.105 0.150 –	0.150 0.200 0.450	Vdc
Base–Emitter Saturation Voltage (I _C = 3.0 Adc, I _B = 0.3 Adc)	V _{BE(sat)}	–	–	1.25	Vdc
Base–Emitter On Voltage (I _C = 1.2 Adc, V _{CE} = 4.0 Vdc)	V _{BE(on)}	–	–	1.10	Vdc
DC Current Gain (I _C = 0.8 Adc, V _{CE} = 1.0 Vdc) (I _C = 1.2 Adc, V _{CE} = 1.0 Vdc) (I _C = 3.0 Adc, V _{CE} = 1.0 Vdc)	h _{FE}	85 80 60	200 – –	– – –	–

DYNAMIC CHARACTERISTICS

Output Capacitance (V _{CB} = 10 Vdc, I _E = 0 Adc, f = 1.0 MHz)	C _{ob}	–	85	135	pF
Input Capacitance (V _{EB} = 8.0 Vdc)	C _{ib}	–	200	–	pF
Current–Gain – Bandwidth Product (Note 2) (I _C = 500 mA, V _{CE} = 10 Vdc, F _{test} = 1.0 MHz)	f _T	–	72	–	MHz

1. Pulse Test: Pulse Width ≤ 300 μs, Duty Cycle ≤ 2%.
2. f_T = |h_{FE}| • f_{test}

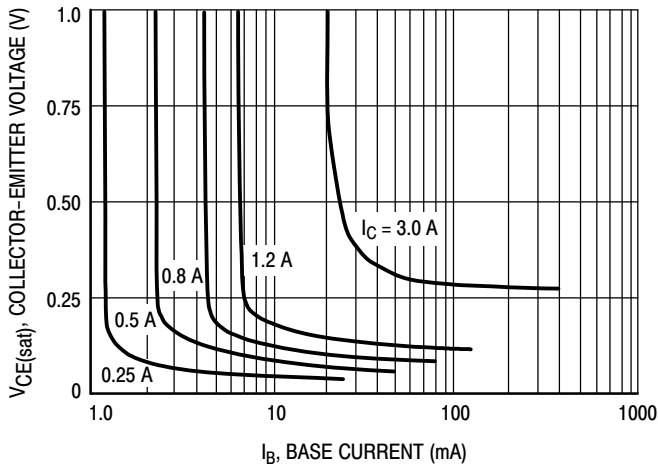

Figure 1. Collector Saturation Region

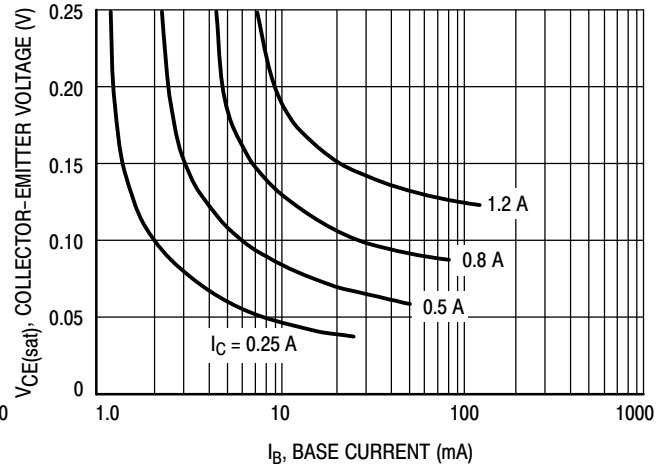

Figure 2. Collector Saturation Region

MMJT9410

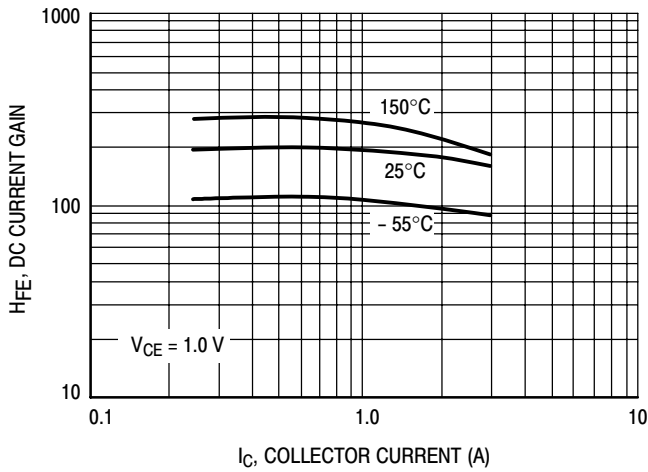

Figure 3. DC Current Gain

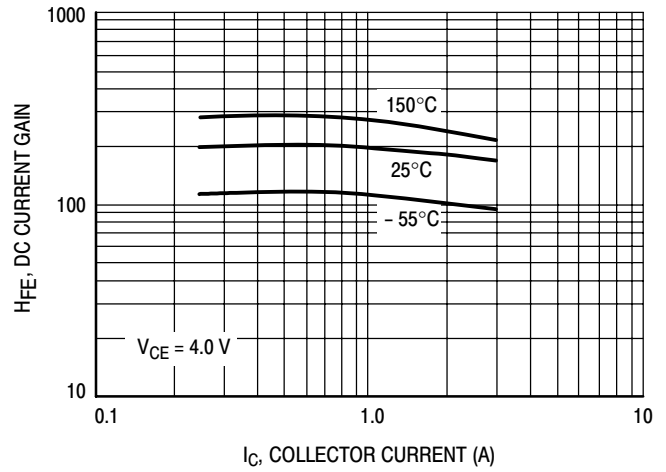

Figure 4. DC Current Gain

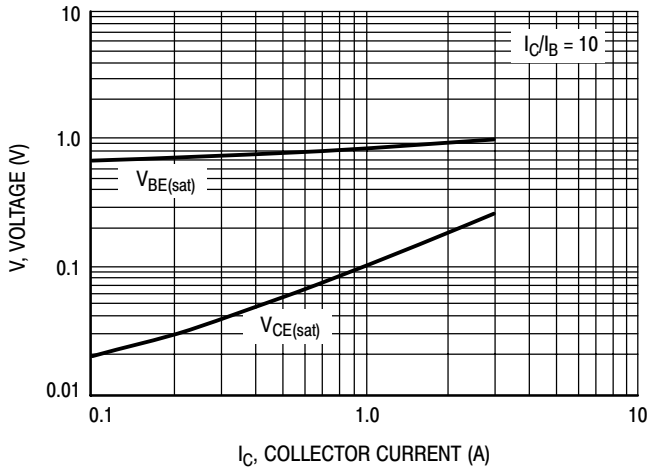

Figure 5. "On" Voltages

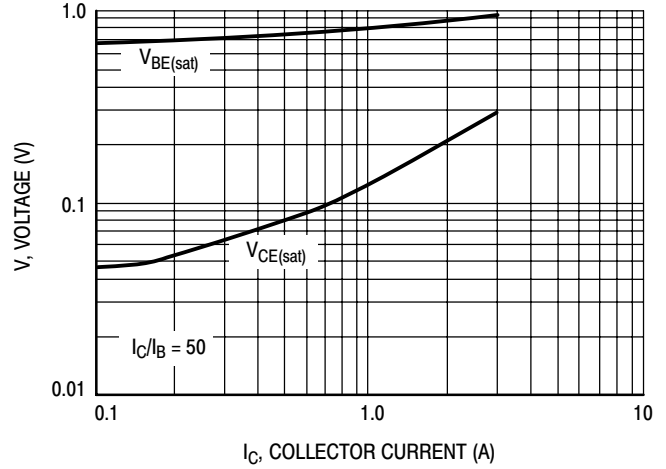

Figure 6. "On" Voltages

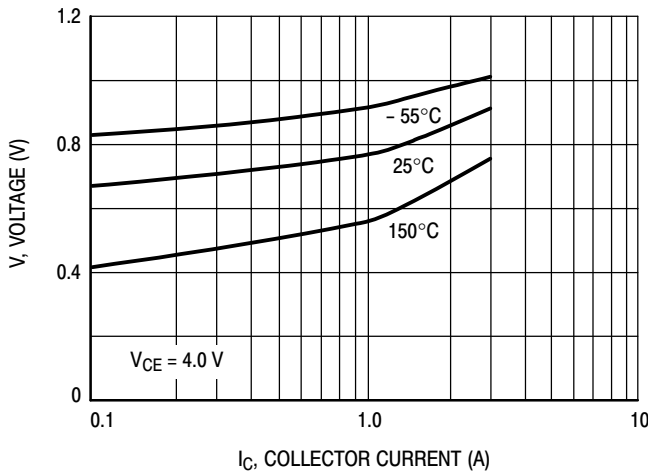

Figure 7. $V_{BE(on)}$ Voltage

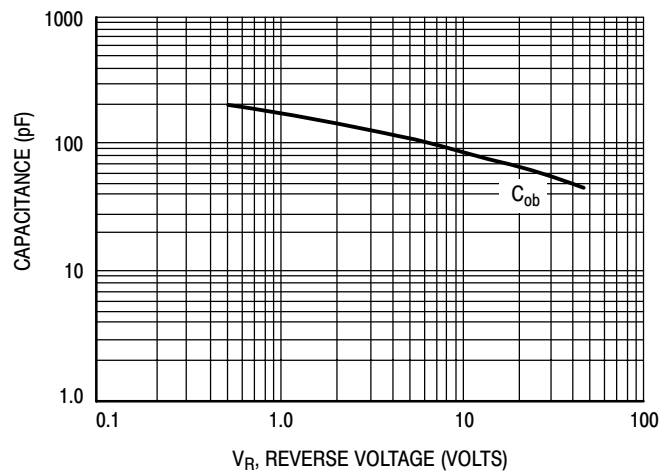

Figure 8. Capacitance

MMJT9410

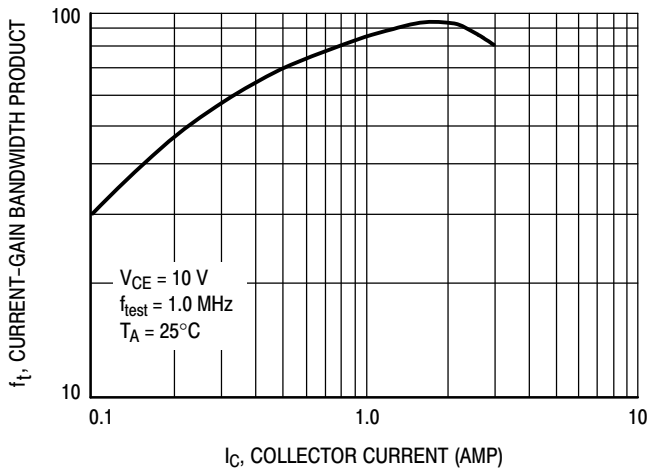

Figure 9. Current-Gain Bandwidth Product

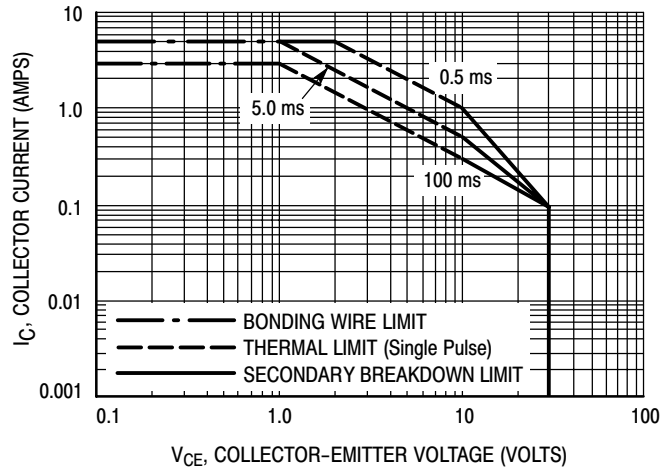

Figure 10. Active Region Safe Operating Area

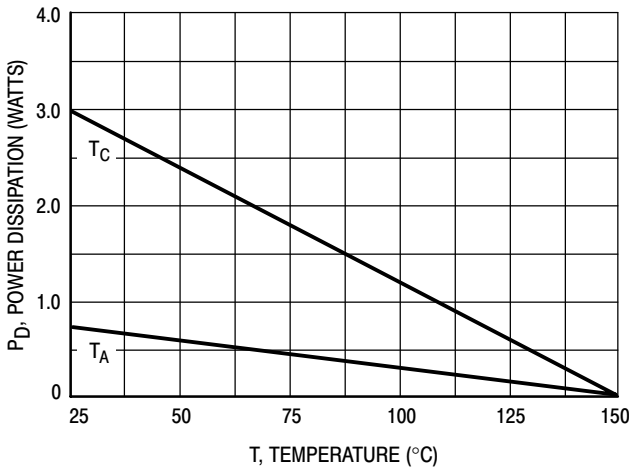

Figure 11. Power Derating

There are two limitations on the power handling ability of a transistor: average junction temperature and secondary breakdown. Safe operating area curves indicate $I_C - V_{CE}$ limits of the transistor that must be observed for reliable operation; i.e., the transistor must not be subjected to greater dissipation than the curves indicate.

The data of Figure 10 is based on $T_{J(pk)} = 150^\circ\text{C}$; T_C is variable depending on conditions. Secondary breakdown pulse limits are valid for duty cycles to 10% provided $T_{J(pk)} \leq 150^\circ\text{C}$. $T_{J(pk)}$ may be calculated from the data in Figure 12. At high case temperatures, thermal limitations will reduce the power that can be handled to values less than the limitations imposed by secondary breakdown.

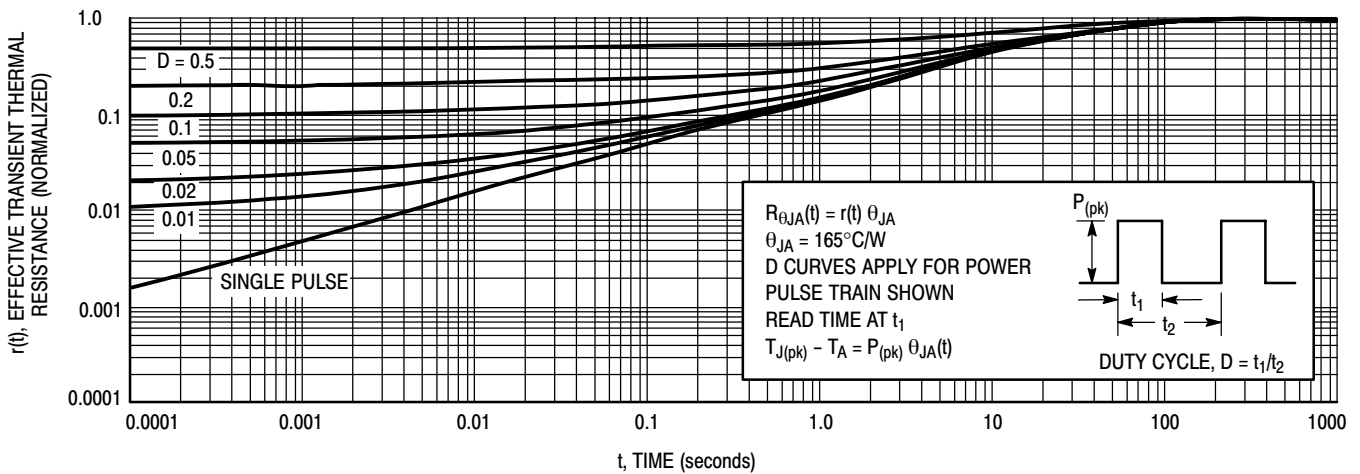
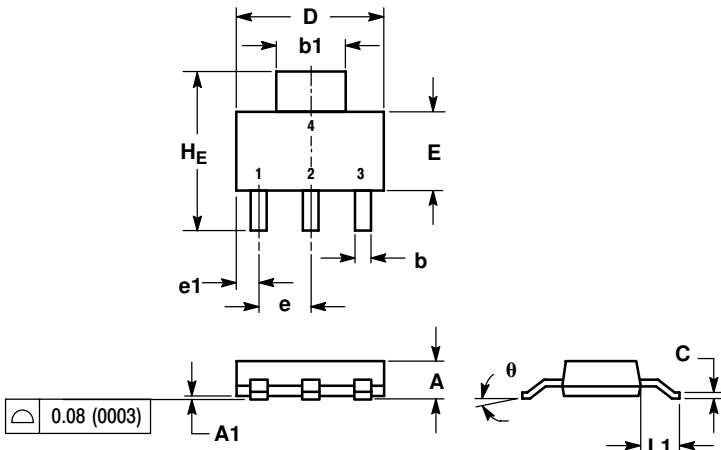

Figure 12. Thermal Response

MMJT9410

PACKAGE DIMENSIONS

SOT-223 (TO-261)
CASE 318E-04
ISSUE L



NOTES:

1. DIMENSIONING AND TOLERANCING PER ANSI Y14.5M, 1982.
2. CONTROLLING DIMENSION: INCH.

DIM	MILLIMETERS			INCHES		
	MIN	NOM	MAX	MIN	NOM	MAX
A	1.50	1.63	1.75	0.060	0.064	0.068
A1	0.02	0.06	0.10	0.001	0.002	0.004
b	0.60	0.75	0.89	0.024	0.030	0.035
b1	2.90	3.06	3.20	0.115	0.121	0.126
c	0.24	0.29	0.35	0.009	0.012	0.014
D	6.30	6.50	6.70	0.249	0.256	0.263
E	3.30	3.50	3.70	0.130	0.138	0.145
e	2.20	2.30	2.40	0.087	0.091	0.094
e1	0.85	0.94	1.05	0.033	0.037	0.041
L1	1.50	1.75	2.00	0.060	0.069	0.078
HE	6.70	7.00	7.30	0.264	0.276	0.287
θ	0°	-	10°	0°	-	10°

STYLE 1:

1. BASE
2. COLLECTOR
3. EMITTER
4. COLLECTOR

SOLDERING FOOTPRINT*

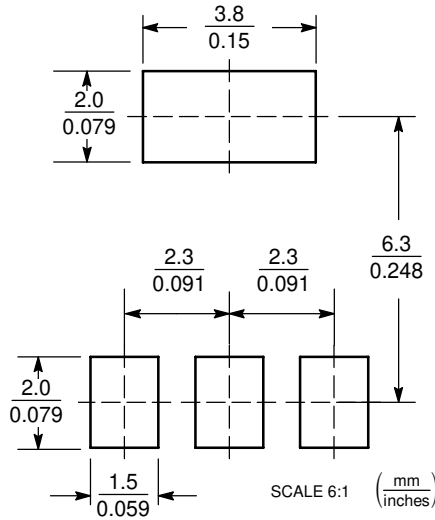

*For additional information on our Pb-Free strategy and soldering details, please download the ON Semiconductor Soldering and Mounting Techniques Reference Manual, SOLDERRM/D.

ON Semiconductor and are registered trademarks of Semiconductor Components Industries, LLC (SCILLC). SCILLC reserves the right to make changes without further notice to any products herein. SCILLC makes no warranty, representation or guarantee regarding the suitability of its products for any particular purpose, nor does SCILLC assume any liability arising out of the application or use of any product or circuit, and specifically disclaims any and all liability, including without limitation special, consequential or incidental damages. "Typical" parameters which may be provided in SCILLC data sheets and/or specifications can and do vary in different applications and actual performance may vary over time. All operating parameters, including "Typicals" must be validated for each customer application by customer's technical experts. SCILLC does not convey any license under its patent rights nor the rights of others. SCILLC products are not designed, intended, or authorized for use as components in systems intended for surgical implant into the body, or other applications intended to support or sustain life, or for any other application in which the failure of the SCILLC product could create a situation where personal injury or death may occur. Should Buyer purchase or use SCILLC products for any such unintended or unauthorized application, Buyer shall indemnify and hold SCILLC and its officers, employees, subsidiaries, affiliates, and distributors harmless against all claims, costs, damages, and expenses, and reasonable attorney fees arising out of, directly or indirectly, any claim of personal injury or death associated with such unintended or unauthorized use, even if such claim alleges that SCILLC was negligent regarding the design or manufacture of the part. SCILLC is an Equal Opportunity/Affirmative Action Employer. This literature is subject to all applicable copyright laws and is not for resale in any manner.

PUBLICATION ORDERING INFORMATION

LITERATURE FULFILLMENT:

Literature Distribution Center for ON Semiconductor
P.O. Box 5163, Denver, Colorado 80217 USA
Phone: 303-675-2175 or 800-344-3860 Toll Free USA/Canada
Fax: 303-675-2176 or 800-344-3867 Toll Free USA/Canada
Email: orderlit@onsemi.com

N. American Technical Support: 800-282-9855 Toll Free
USA/Canada
Europe, Middle East and Africa Technical Support:
Phone: 421 33 790 2910
Japan Customer Focus Center
Phone: 81-3-5773-3850

ON Semiconductor Website: www.onsemi.com

Order Literature: <http://www.onsemi.com/orderlit>

For additional information, please contact your local Sales Representative