



Chipsmall Limited consists of a professional team with an average of over 10 year of expertise in the distribution of electronic components. Based in Hongkong, we have already established firm and mutual-benefit business relationships with customers from,Europe,America and south Asia,supplying obsolete and hard-to-find components to meet their specific needs.

With the principle of “Quality Parts,Customers Priority,Honest Operation,and Considerate Service”,our business mainly focus on the distribution of electronic components. Line cards we deal with include Microchip,ALPS,ROHM,Xilinx,Pulse,ON,Everlight and Freescale. Main products comprise IC,Modules,Potentiometer,IC Socket,Relay,Connector.Our parts cover such applications as commercial,industrial, and automotives areas.

We are looking forward to setting up business relationship with you and hope to provide you with the best service and solution. Let us make a better world for our industry!



Contact us

Tel: +86-755-8981 8866 Fax: +86-755-8427 6832

Email & Skype: info@chipsmall.com Web: www.chipsmall.com

Address: A1208, Overseas Decoration Building, #122 Zhenhua RD., Futian, Shenzhen, China



Features

- Planar Die Construction
- Small Surface Mount Package
- General Purpose
- Ideally Suited for Automated Assembly Processes
- **Totally Lead-Free & Fully RoHS Compliant (Notes 1 & 2)**
- **Halogen and Antimony Free. "Green" Device (Note 3)**

Mechanical Data

- Case: SOD323
- Case Material: Molded Plastic. UL Flammability Classification Rating 94V-0
- Moisture Sensitivity: Level 1 per J-STD-020D
- Terminals: Solderable per MIL-STD-202, Method 208 ③
- Lead Free Plating (Matte Tin Finish annealed over Alloy 42 leadframe). Polarity: Cathode Band
- Weight: 0.004 grams (approximate)



Top View

Ordering Information (Note 4)

Part Number	Case	Packaging
(Type Number)-7-F*	SOD-323	3000/Tape & Reel
(Type Number)-13-F* (Note 5)	SOD-323	10000/Tape & Reel

* For (Type Number), please see the Electrical Characteristics Table. Example: 6.2V Zener = MMSZ5234BS-7-F.

- Notes:
1. No purposely added lead. Fully EU Directive 2002/95/EC (RoHS) & 2011/65/EU (RoHS 2) compliant.
 2. See http://www.diodes.com/quality/lead_free.html for more information about Diodes Incorporated's definitions of Halogen- and Antimony-free, "Green" and Lead-free.
 3. Halogen- and Antimony-free "Green" products are defined as those which contain <900ppm bromine, <900ppm chlorine (<1500ppm total Br + Cl) and <1000ppm antimony compounds.
 4. For packaging details, go to our website at <http://www.diodes.com/products/packages.html>
 5. Devices are readily available on 13" reels for select voltages only. For other voltages, devices can be made available on 13" reels upon request. Please contact your Diodes Inc. sales representative for additional details.

Marking Information

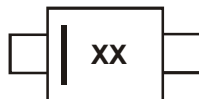

XX = Product Type Marking Code
(See Electrical Characteristics Table)

Maximum Ratings (@T_A = +25°C, unless otherwise specified.)

Characteristic	Symbol	Value	Unit
Forward Voltage (Note 6) @ I _F = 10mA	V _F	0.9	V

Thermal Characteristics

Characteristic	Symbol	Value	Unit
Power Dissipation (Note 7)	P _D	200	mW
Thermal Resistance, Junction to Ambient Air (Note 7)	R _{θJA}	625	°C/W
Operating and Storage Temperature Range	T _J , T _{STG}	-65 to +150	°C

Electrical Characteristics (@T_A = +25°C, unless otherwise specified.)

Type Number	Marking Code	Zener Voltage Range (Note 8)			Test Current	Maximum Zener Impedance (Note 9)		Maximum Reverse Leakage Current (Note 8)	
		V _Z @ I _{ZT}				I _{ZT}	Z _{ZT} @ I _{ZT}	Z _{ZK} @ I _{ZK} = 0.25mA	I _R
		Nom (V)	Min (V)	Max (V)	mA				
MMSZ5221BS	C1	2.4	2.28	2.52	20	30	1200	100	1.0
MMSZ5223BS	C3	2.7	2.57	2.84	20	30	1300	75	1.0
MMSZ5225BS	C5	3.0	2.85	3.15	20	30	1600	50	1.0
MMSZ5226BS	G1	3.3	3.14	3.47	20	28	1600	25	1.0
MMSZ5227BS	G2	3.6	3.42	3.78	20	24	1700	15	1.0
MMSZ5228BS	G3	3.9	3.71	4.10	20	23	1900	10	1.0
MMSZ5229BS	G4	4.3	4.09	4.52	20	22	2000	5.0	1.0
MMSZ5230BS	G5	4.7	4.47	4.94	20	19	1900	5.0	2.0
MMSZ5231BS	E1	5.1	4.85	5.36	20	17	1600	5.0	2.0
MMSZ5232BS	E2	5.6	5.32	5.88	20	11	1600	5.0	3.0
MMSZ5233BS	E3	6.0	5.70	6.30	20	7	1600	5.0	3.5
MMSZ5234BS	E4	6.2	5.89	6.51	20	7	1000	5.0	4.0
MMSZ5235BS	E5	6.8	6.46	7.14	20	5	750	3.0	5.0
MMSZ5236BS	F1	7.5	7.13	7.88	20	6	500	3.0	6.0
MMSZ5237BS	F2	8.2	7.79	8.61	20	8	500	3.0	6.5
MMSZ5238BS	F3	8.7	8.27	9.14	20	8	600	3.0	6.5
MMSZ5239BS	F4	9.1	8.65	9.56	20	10	600	3.0	7.0
MMSZ5240BS	F5	10	9.50	10.50	20	17	600	3.0	8.0
MMSZ5241BS	H1	11	10.45	11.55	20	22	600	2.0	8.4
MMSZ5242BS	H2	12	11.40	12.60	20	30	600	1.0	9.1
MMSZ5243BS	H3	13	12.35	13.65	9.5	13	600	0.5	9.9
MMSZ5245BS	H5	15	14.25	15.75	8.5	16	600	0.1	11
MMSZ5246BS	J1	16	15.20	16.80	7.8	17	600	0.1	12
MMSZ5248BS	J3	18	17.10	18.90	7.0	21	600	0.1	14
MMSZ5250BS	J5	20	19.00	21.00	6.2	25	600	0.1	15
MMSZ5251BS	K1	22	20.90	23.10	5.6	29	600	0.1	17
MMSZ5252BS	K2	24	22.80	25.20	5.2	33	600	0.1	18
MMSZ5254BS	K4	27	25.65	28.35	5.0	41	600	0.1	21
MMSZ5255BS	K5	28	26.60	29.40	4.5	44	600	0.1	21
MMSZ5256BS	M1	30	28.50	31.50	4.2	49	600	0.1	23
MMSZ5257BS	M2	33	31.35	34.65	3.8	58	700	0.1	25
MMSZ5258BS	M3	36	34.20	37.80	3.4	70	700	0.1	27
MMSZ5259BS	M4	39	37.05	40.95	3.2	80	800	0.1	30

- Notes:
6. Short duration pulse test used to minimize self-heating effect.
 7. Part mounted on FR-4 PC board with recommended pad layout, which can be found on our website at <http://www.diodes.com/datasheets/ap02001.pdf>
 8. Short duration pulse test used to minimize self-heating effect.
 9. f = 1KHz.

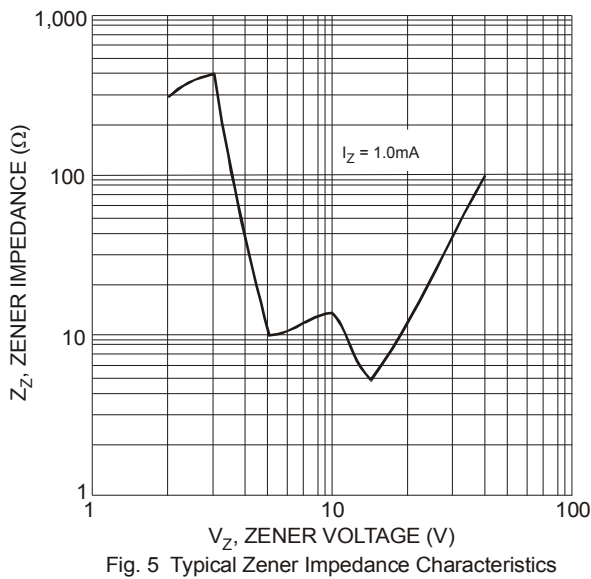
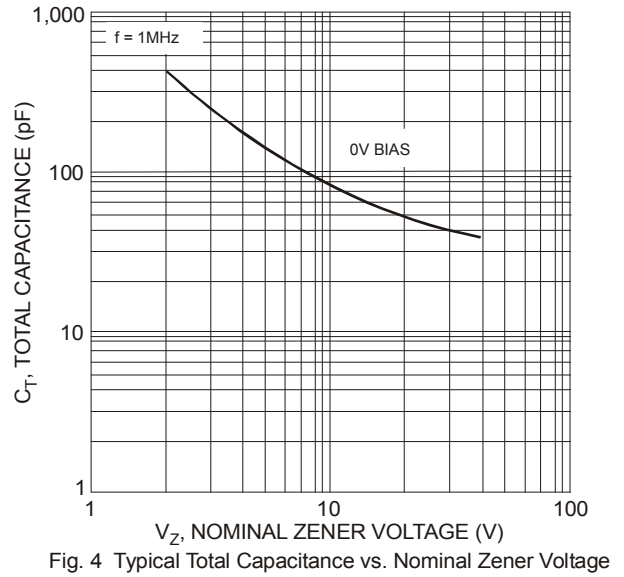
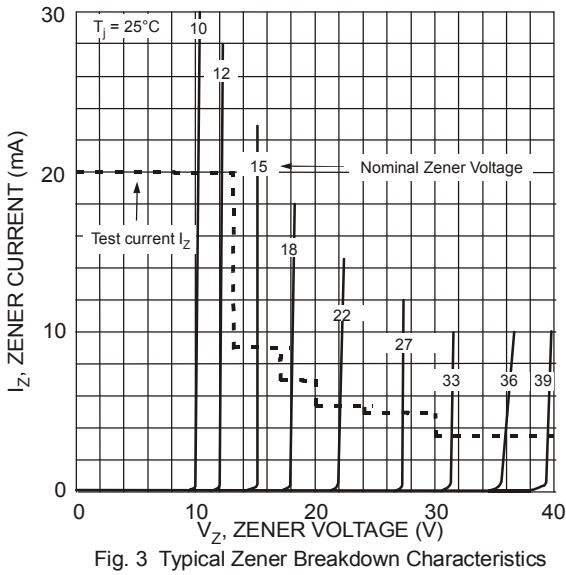
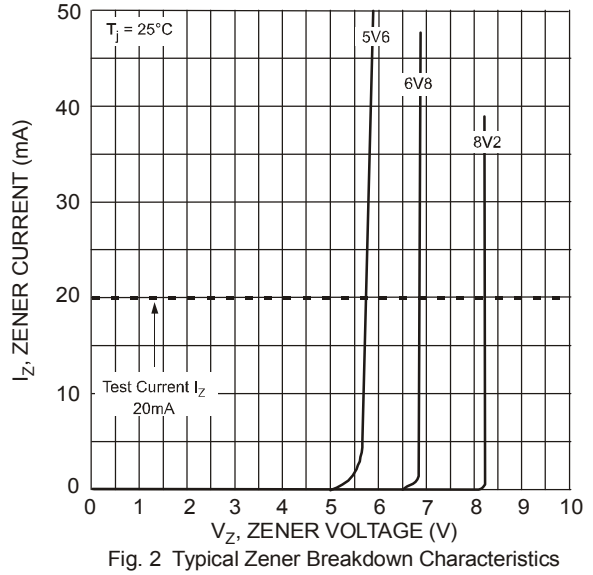
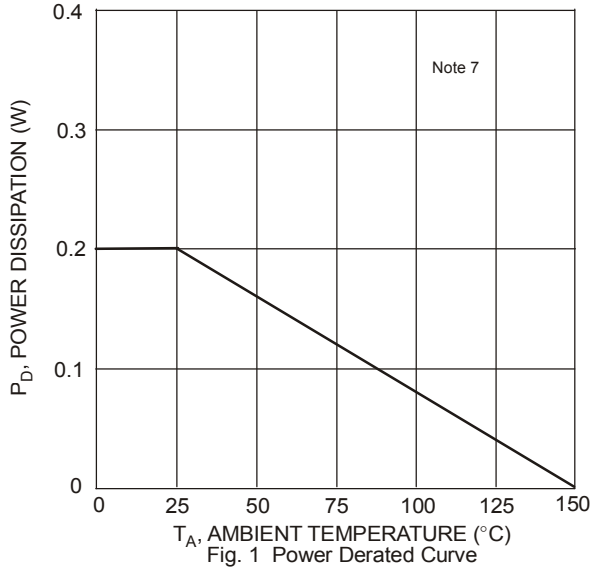

Package Outline Dimensions

Please see AP02002 at <http://www.diodes.com/datasheets/ap02002.pdf> for latest version.

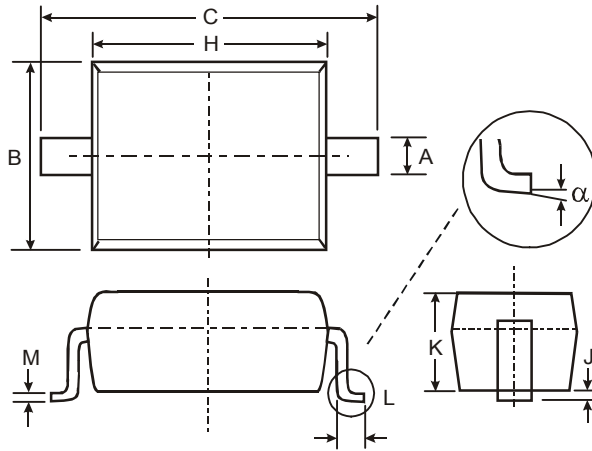

SOD323		
Dim	Min	Max
A	0.25	0.35
B	1.20	1.40
C	2.30	2.70
H	1.60	1.80
J	0.00	0.10
K	1.0	1.1
L	0.20	0.40
M	0.10	0.15
α	0°	8°
All Dimensions in mm		

Suggested Pad Layout

Please see AP02001 at <http://www.diodes.com/datasheets/ap02001.pdf> for latest version.

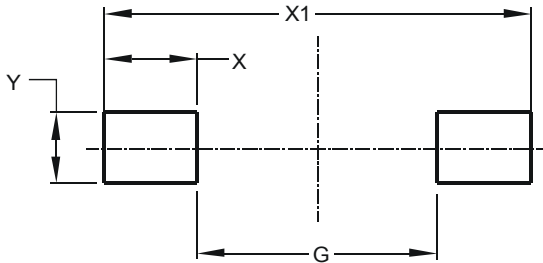

Dimensions	Value (in mm)
G	1.520
X	0.590
X1	2.700
Y	0.450

IMPORTANT NOTICE

DIODES INCORPORATED MAKES NO WARRANTY OF ANY KIND, EXPRESS OR IMPLIED, WITH REGARDS TO THIS DOCUMENT, INCLUDING, BUT NOT LIMITED TO, THE IMPLIED WARRANTIES OF MERCHANTABILITY AND FITNESS FOR A PARTICULAR PURPOSE (AND THEIR EQUIVALENTS UNDER THE LAWS OF ANY JURISDICTION).

Diodes Incorporated and its subsidiaries reserve the right to make modifications, enhancements, improvements, corrections or other changes without further notice to this document and any product described herein. Diodes Incorporated does not assume any liability arising out of the application or use of this document or any product described herein; neither does Diodes Incorporated convey any license under its patent or trademark rights, nor the rights of others. Any Customer or user of this document or products described herein in such applications shall assume all risks of such use and will agree to hold Diodes Incorporated and all the companies whose products are represented on Diodes Incorporated website, harmless against all damages.

Diodes Incorporated does not warrant or accept any liability whatsoever in respect of any products purchased through unauthorized sales channel. Should Customers purchase or use Diodes Incorporated products for any unintended or unauthorized application, Customers shall indemnify and hold Diodes Incorporated and its representatives harmless against all claims, damages, expenses, and attorney fees arising out of, directly or indirectly, any claim of personal injury or death associated with such unintended or unauthorized application.

Products described herein may be covered by one or more United States, international or foreign patents pending. Product names and markings noted herein may also be covered by one or more United States, international or foreign trademarks.

This document is written in English but may be translated into multiple languages for reference. Only the English version of this document is the final and determinative format released by Diodes Incorporated.

LIFE SUPPORT

Diodes Incorporated products are specifically not authorized for use as critical components in life support devices or systems without the express written approval of the Chief Executive Officer of Diodes Incorporated. As used herein:

A. Life support devices or systems are devices or systems which:

1. are intended to implant into the body, or
2. support or sustain life and whose failure to perform when properly used in accordance with instructions for use provided in the labeling can be reasonably expected to result in significant injury to the user.

B. A critical component is any component in a life support device or system whose failure to perform can be reasonably expected to cause the failure of the life support device or to affect its safety or effectiveness.

Customers represent that they have all necessary expertise in the safety and regulatory ramifications of their life support devices or systems, and acknowledge and agree that they are solely responsible for all legal, regulatory and safety-related requirements concerning their products and any use of Diodes Incorporated products in such safety-critical, life support devices or systems, notwithstanding any devices- or systems-related information or support that may be provided by Diodes Incorporated. Further, Customers must fully indemnify Diodes Incorporated and its representatives against any damages arising out of the use of Diodes Incorporated products in such safety-critical, life support devices or systems.

Copyright © 2014, Diodes Incorporated

www.diodes.com