



Chipsmall Limited consists of a professional team with an average of over 10 year of expertise in the distribution of electronic components. Based in Hongkong, we have already established firm and mutual-benefit business relationships with customers from,Europe,America and south Asia,supplying obsolete and hard-to-find components to meet their specific needs.

With the principle of “Quality Parts,Customers Priority,Honest Operation,and Considerate Service”,our business mainly focus on the distribution of electronic components. Line cards we deal with include Microchip,ALPS,ROHM,Xilinx,Pulse,ON,Everlight and Freescale. Main products comprise IC,Modules,Potentiometer,IC Socket,Relay,Connector.Our parts cover such applications as commercial,industrial, and automotives areas.

We are looking forward to setting up business relationship with you and hope to provide you with the best service and solution. Let us make a better world for our industry!



## Contact us

Tel: +86-755-8981 8866 Fax: +86-755-8427 6832

Email & Skype: info@chipsmall.com Web: www.chipsmall.com

Address: A1208, Overseas Decoration Building, #122 Zhenhua RD., Futian, Shenzhen, China



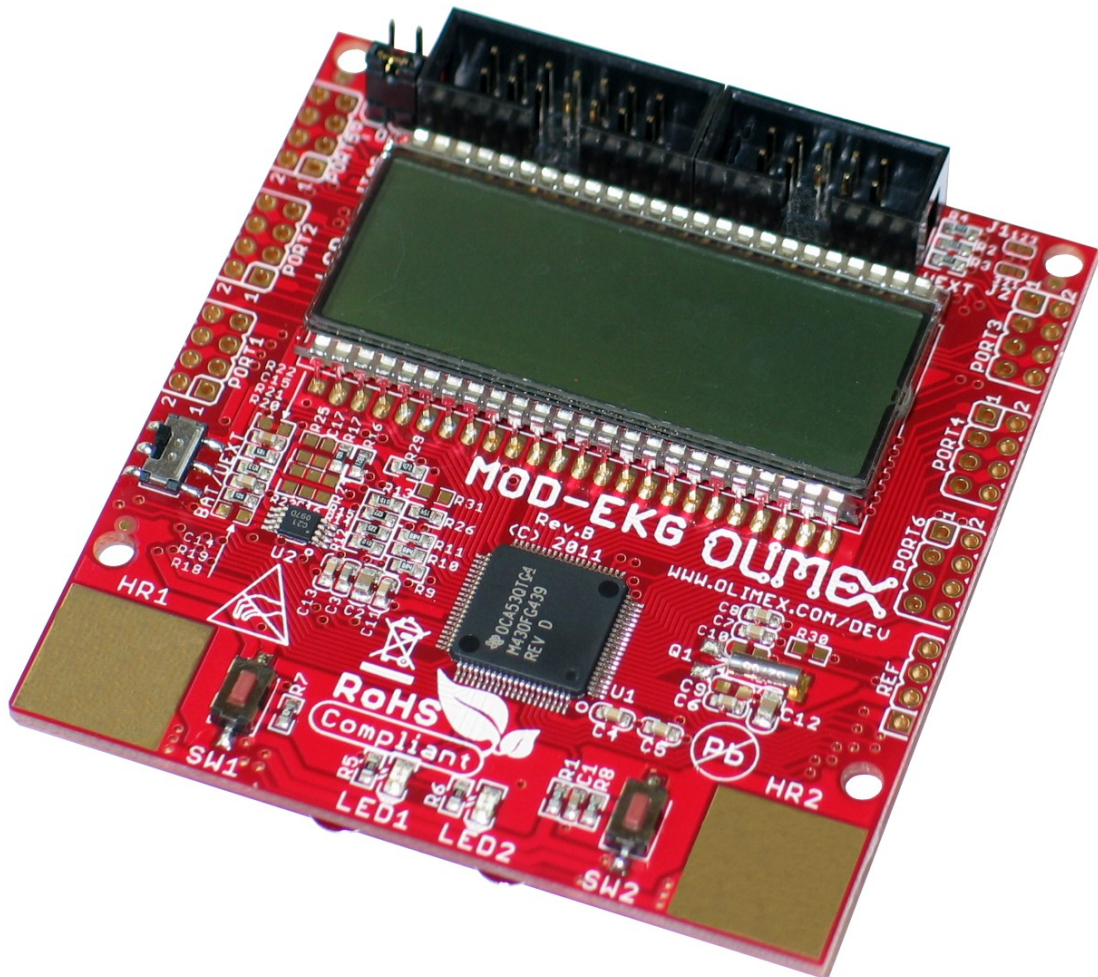

## MOD-EKG development board User's manual



All boards produced by Olimex are ROHS compliant  
**Document revision B, December 2016**

## **INTRODUCTION:**

MOD-EKG is an implementation of the hardware design proposed by Texas Instruments in their document “Heart-Rate and EKG Monitor Using the MSP430FG439” (document name “slaa280a”). MOD-EKG is an open-hardware, open-software project. The user places his index fingers and thumbs at the metallic pads of the board and the heartbeat rate per minute gets displayed on the LCD. In addition, the application outputs a digital data stream to a serial data interface which allows you to display EKG waveform on a PC. The serial interface is available at the UEXT connector. Using our serial ↔ USB adapter. A connection between the PC and MOD-EKG can be achieved by using our adapter – MOD-USB-RS232 that converts the serial interface to USB, and vice versa.

An electrocardiogram (ECG), also called an EKG, is a graphic showing the voltage generated by the heart muscle during a heartbeat. In this application, the EKG waveform is used by the MCU to measure the heartbeat rate. Because heartbeat calculation is the major focus the electrodes are simplified to two points for collecting data, one for the right hand and the other for the left hand.

## **BOARD FEATURES:**

- Microcontroller: **MSP430FG439**
- EKG amplifiers with **INA321EA**
- 14-pin 0.1” step JTAG connector for direct microcontroller access via MSP430 debugger to debug the software or to power the board
- UEXT connector that allows easier connection to other boards
- Custom LCD display
- 3V CR2032 Lithium coin battery holder
- Extension rows of pinholes for all microcontroller ports – with no plastic connectors placed
- No additional electrodes required! Right and left hand contact board-mounted electrodes – HR1 and HR2
- Two status LEDs
- Two user buttons
- A switch to alternate between “battery” and “UEXT” power supply
- Based on Texas Instruments application note SLAA280a
- FR-4, 1.5 mm, red soldermask, white component print
- Dimensions: (3.0 x 2.8)" ~ (76 x 71)mm

## **ELECTROSTATIC WARNING:**

The MOD-EKG board is shipped in protective anti-static packaging. The board must not be subject to high electrostatic potentials. General practice for working with static sensitive devices should be applied when working with this board.

## **BOARD USE REQUIREMENTS:**

In order to set up the PIC32-RETROBSD board optimally one or more additional items may be needed. They might be generally placed in two categories: **Required** – items that are needed in order to achieve minimum functionality; **Recommended** – items that is good to have in order to be able to interact with the most important of the features of the board.

### **a) Required items:**

- A source of power; preferably a battery. MOD-EKG can take power from a number sources:

- 1) +3V CR2032 Lithium battery placed in the battery connector at the back – when switch BAT/UEXT is in position BAT.
- 2) JTAG debugger placed in the JTAG connector – when jumper P\_IN is closed and P\_OUT is opened.
- 3) Pins #1 (3.3V) and #2 (GND) of the UEXT connector – when switch BAT/UEXT is in position UEXT; you can also supply 3V from a battery to these pins

The power supply source gets selected by changing jumpers P\_IN and P\_OUT and using the BAT/UEXT switch.

**IMPORTANT:** MOD-EKG is a sensitive board and glitches or noises in the power supply lines might affect the readings. Even if the USB ports and the power supply unit are of good quality, there is still parasitic capacitance between the human body and mains power line, which affects the readings. Be sure to test with a 3V battery – either insert a good CR2302 coin battery directly in the connector at the back of MOD-EKG or attach a 3V battery to the UEXT. If you wish to power the board from the JTAG or external power supply make sure there is galvanic isolation or good filtering between the power supply and the MOD-EKG board. For example, if you want to isolate your JTAG debugger from the mains power influence you can use our USB-ISO product (between the computer's USB port and the JTAG debugger).

### **b) Recommended items:**

- serial to USB adapter board – to connect to a personal computer; you can use a number of our low cost solutions, for example, [BB-340CH](#) or [MOD-USB-RS232](#); note that the examples for computer connection use MOD-USB-RS232

- MSP430-compatible debugger with 14-pin (2 x 7) 0.1” step connector; if you want a compatible low-cost Olimex product consider [MSP430-JTAG-TINY-V2](#) or [MSP430-JTAG-ISO-MK2](#)

## **PROCESSOR FEATURES:**

MOD-EKG board uses ultralow power microcontroller MSP430FG439 from Texas Instruments with the following features:

- Low Supply-Voltage Range, 1.8 V to 3.6 V
- Ultralow-Power Consumption:
  - Active Mode: 300  $\mu$ A at 1 MHz, 2.2 V
  - Standby Mode: 1.1  $\mu$ A
  - Off Mode (RAM Retention): 0.1  $\mu$ A
- Five Power Saving Modes
- Wake-Up From Standby Mode in Less Than 6  $\mu$ s
- 16-Bit RISC Architecture, 125-ns Instruction Cycle Time
- Single-Channel Internal DMA
- 12-Bit A/D Converter With Internal Reference, Sample-and-Hold and Autoscan Feature
- Three Configurable Operational Amplifiers
- Dual 12-Bit D/A Converters With Synchronization
- 16-Bit Timer\_A With Three Capture/Compare Registers
- 16-Bit Timer\_B With Three Capture/Compare-With-Shadow Registers
- On-Chip Comparator
- Serial Communication Interface (USART), Select Asynchronous UART or Synchronous SPI by Software
- Brownout Detector
- Supply Voltage Supervisor/Monitor With Programmable Level Detection
- Bootstrap Loader
- Serial Onboard Programming, No External Programming Voltage Needed  
Programmable Code Protection by Security Fuse
- Integrated LCD Driver for Up to 128 Segments
- 60KB+256B Flash Memory
- 2KB RAM

# BLOCK DIAGRAM:

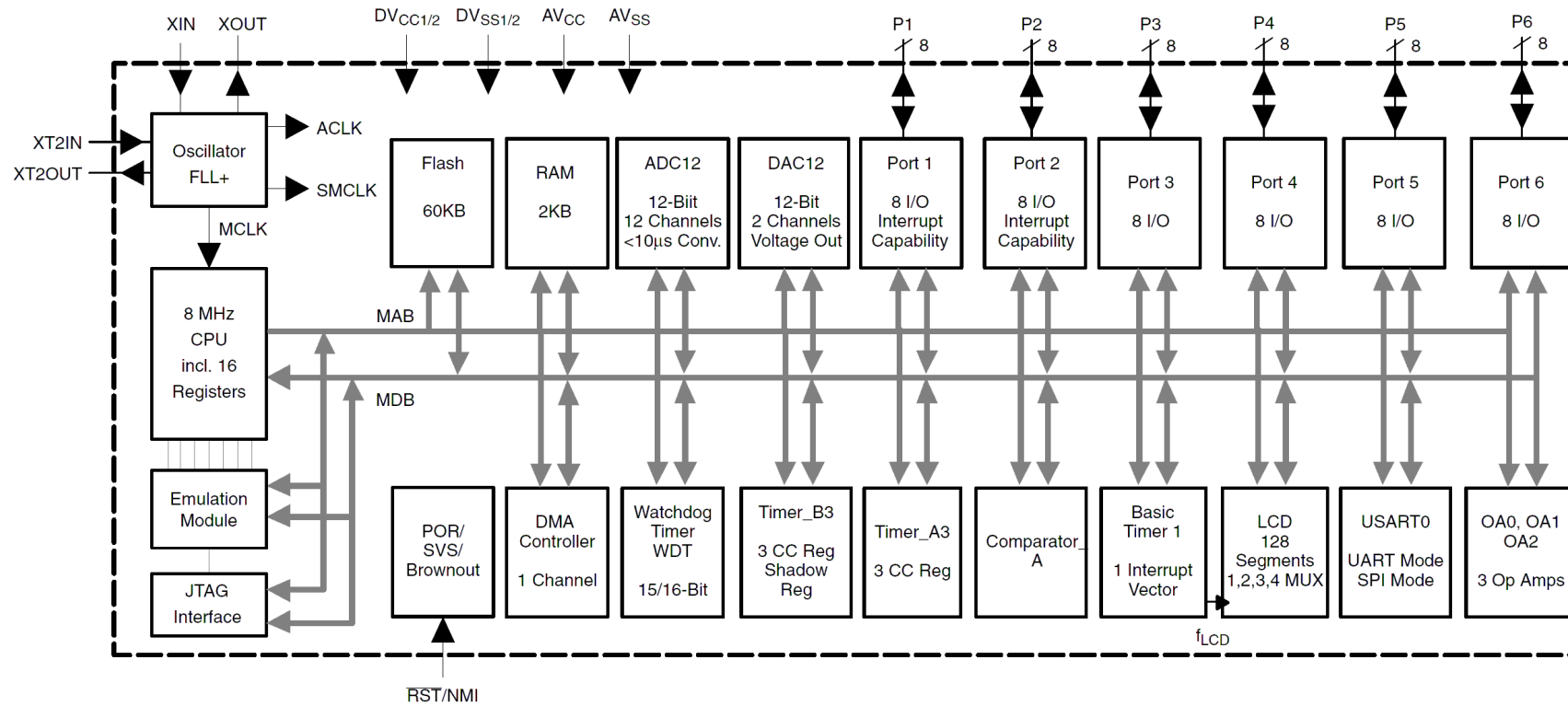

**MEMORY ORGANIZATION:**

Memory Main: interrupt vector Main: code memory	Size Flash Flash	60KB 0FFFFh – 0FFE0h 0FFFFh – 01100h
Information memory	Size Flash	256 Byte 010FFh – 01000h
Boot memory	Size ROM	1KB 0FFFh – 0C00h
RAM	Size	2KB 09FFh – 0200h
Peripherals	16-bit 8-bit 8-bit SFR	01FFh – 0100h 0FFh – 010h 0Fh – 00h

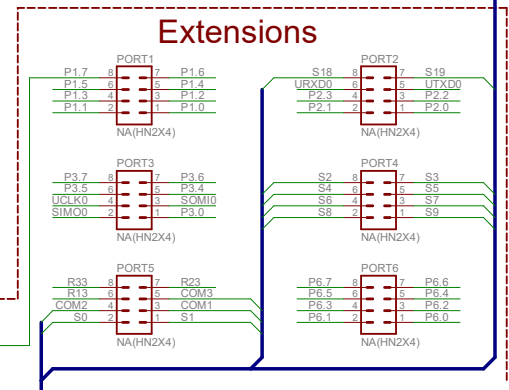
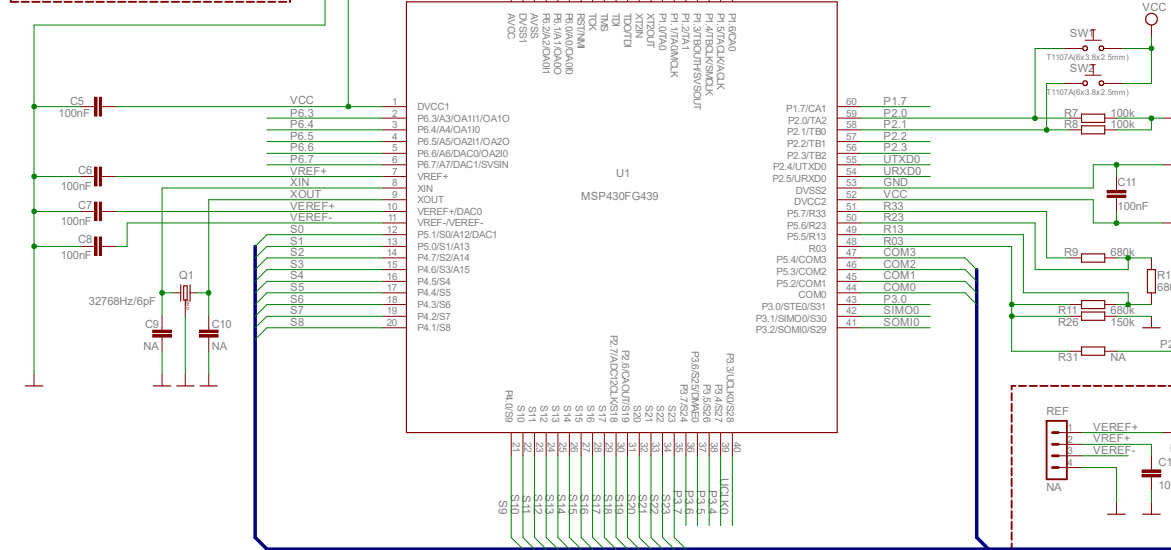
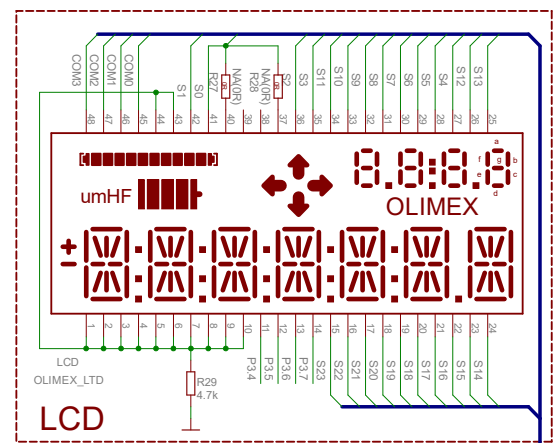
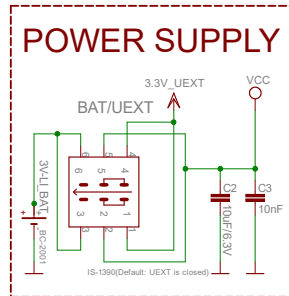
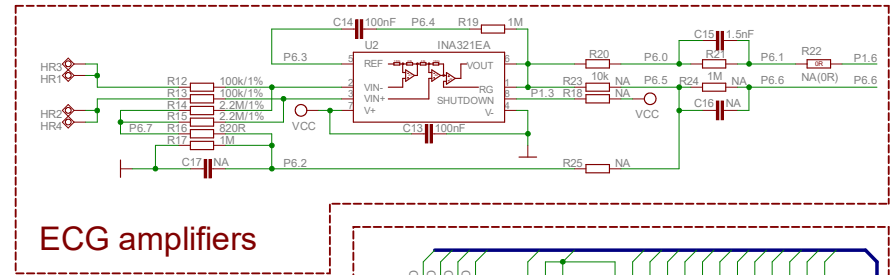
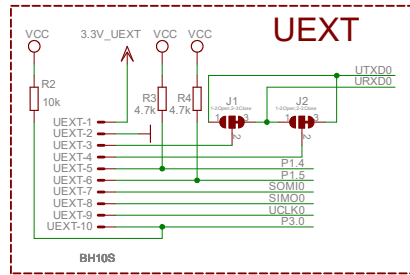
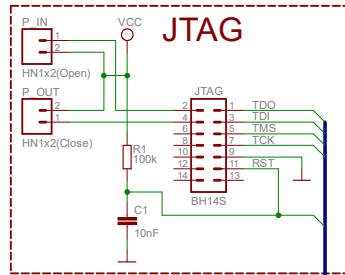

**MOD-EKG**

Rev. B  
COPYRIGHT(C) 2011, OLIMEX Ltd.  
<http://www.olimex.com/dev>



**BOARD LAYOUT:**

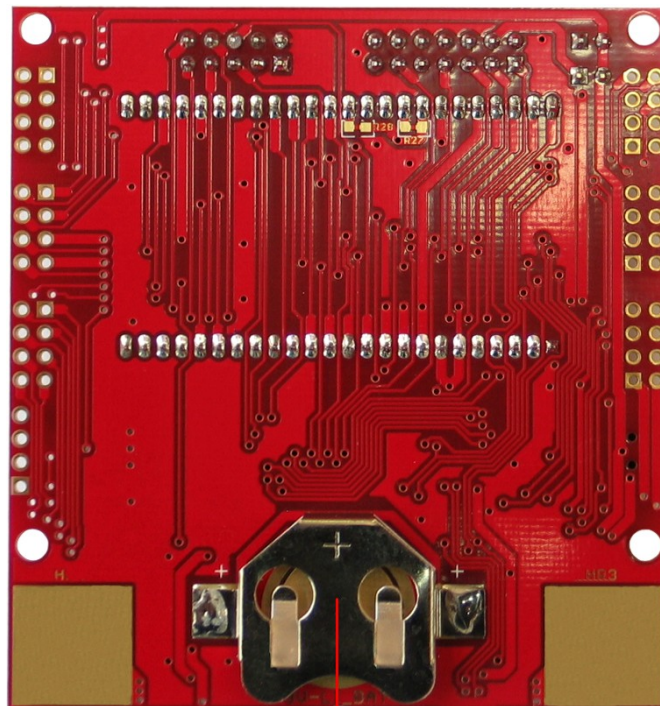
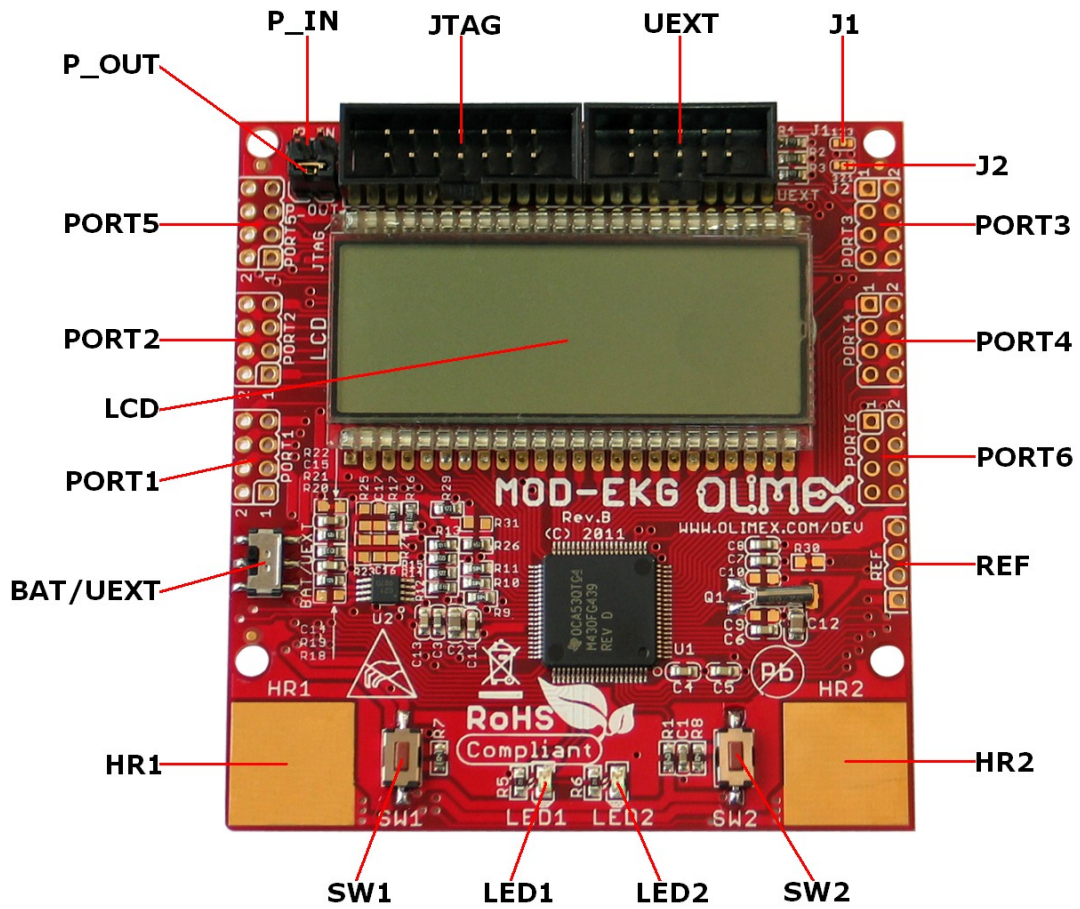

**3V-LI\_BAT**

## **POWER SUPPLY CIRCUIT:**

MOD-EKG can take power from:

- 1) +3V CR2032 Lithium battery placed in the battery connector at the back – when switch BAT/UEXT is in position BAT.
- 2) JTAG debugger placed in the JTAG connector – when jumper P\_IN is closed and P\_OUT is opened.
- 3) Pins #1 (3.3V) and #2 (GND) of the UEXT connector – when switch BAT/UEXT is in position UEXT; you can also supply 3V from a battery to these pins

The power supply source gets selected by changing jumpers P\_IN and P\_OUT and using the BAT/UEXT switch.

## **RESET CIRCUIT:**

MOD-EKG reset circuit includes R1 (100k), C1(10nF), JTAG pin 11 and MSP430FG439 pin 74 (RST/NMI).

## **CLOCK CIRCUIT:**

Quartz crystal (Q1) 32.768 kHz is connected to MSP430FG439 pin 8 (XIN) and pin 9 (XOUT).

## **JUMPER DESCRIPTION:**

### **P\_IN**



When this jumper is closed, the board is power supplied by the standard JTAG pin 2. This is only possible when the consumption of the board is not very high which is typically the case with MSP430 microcontrollers. If this jumper is open the board should be power supplied by another external source. This jumper and P\_OUT should always be reversely open/closed, i.e. if P\_IN is closed, P\_OUT should be open and vice versa.

Default state is opened.

### **P\_OUT**



When this jumper is closed, the board is power supplied not by the JTAG but from external source. Then the JTAG has to synchronize with the working voltages which is done through this line. This is especially important when debugging with JTAG. This jumper and P\_IN should always be reversely

open/closed, i.e. if P\_OUT is closed, P\_IN should be open and vice versa.

Default state is closed.

### J1



When jumper J1 is shorted in position 1-2, UEXT pin 3 is connected to MSP430FG439 pin 55 (P2.4/UTXD0) – signal “UTXD0”. When jumper J1 is shorted in position 2-3, UEXT pin 3 is connected to MSP430FG439 pin 54 (P2.5/URXD0) – signal “URXD0”.

Default state is shorted in position 2-3.

### J2



When jumper J2 is shorted in position 1-2, UEXT pin 4 is connected to MSP430FG439 pin 54 (P2.5/URXD0) – signal “URXD0”. When jumper J2 is shorted in position 2-3, UEXT pin 4 is connected to MSP430FG439 pin 55 (P2.4/UTXD0) – signal “UTXD0”.

Default state is shorted in position 2-3.

Depending on jumpers J1 and J2 configuration, the board can work in host, or in device mode. The default state of J1 and J2 is for device mode (shorted in position 2-3).

## INPUT/OUTPUT:

**LED1 (red)** connected to MSP430FG439 pin 67 (P1.0/TA0).

**LED2 (red)** connected to MSP430FG439 pin 65 (P1.2/TA1).

**User button** with name **SW1** connected to **MSP430FG439** pin 59 (P2.0/TA2).

**User button** with name **SW2** connected to **MSP430FG439** pin 58 (P2.1/TB0).

**Power supply switch** with name **BAT/UEXT** – when in position **BAT** – the board is power supplied via +3V lithium battery, when is in position **UEXT** – the board is connected to other board with UEXT and is power supplied by the other board via UEXT connector.

**LCD** custom display.

**EXTERNAL CONNECTORS DESCRIPTION:**

**UEXT:**

Pin #	Signal Name
1	VDD
2	GND
3	TX
4	RX
5	P1.4
6	P1.5
7	SOMI0
8	SIM00
9	UCLK0
10	P3.0

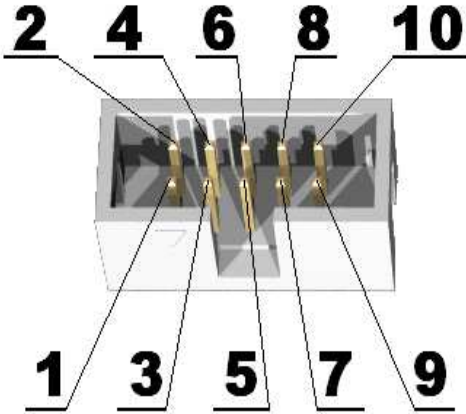

## JTAG:

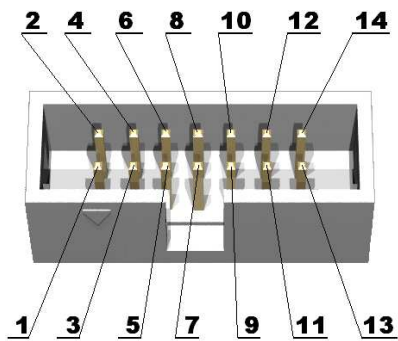

Pin #	Signal Name	Pin #	Signal Name
1	TDO	2	Via P_IN to VCC
3	TDI	4	Via P_OUT to VCC
5	TMS	6	Not Connected
7	TCK	8	Not Connected
9	GND	10	Not Connected
11	RST	12	Not Connected
13	Not Connected	14	Not Connected

## PORT1:

Pin #	Signal Name	Pin #	Signal Name
1	P1.0	2	P1.1
3	P1.2	4	P1.3
5	P1.4	6	P1.5
7	P1.6	8	P1.7

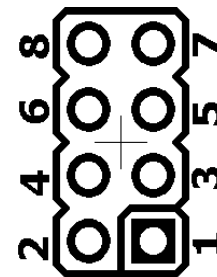

### PORT2:

Pin #	Signal Name	Pin #	Signal Name
1	P2.0	2	P2.1
3	P2.2	4	P2.3
5	UTXD0	6	URXD0
7	S19	8	S18

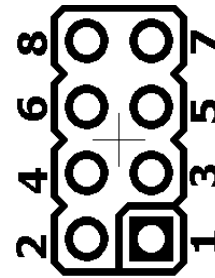

### PORT3:

Pin #	Signal Name	Pin #	Signal Name
1	P3.0	2	SIM00
3	SOMI0	4	UCLK0
5	P3.4	6	P3.5
7	P3.6	8	P3.7

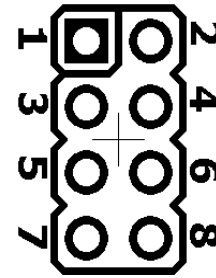

### PORT4:

Pin #	Signal Name	Pin #	Signal Name
1	S9	2	S8
3	S7	4	S6
5	S5	6	S4
7	S3	8	S2

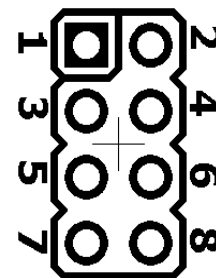

**PORT5:**

Pin #	Signal Name	Pin #	Signal Name
1	S1	2	S0
3	COM1	4	COM2
5	COM3	6	R13
7	R23	8	R33

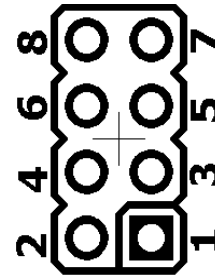

**PORT6:**

Pin #	Signal Name	Pin #	Signal Name
1	P6.0	2	P6.1
3	P6.2	4	P6.3
5	P6.4	6	P6.5
7	P6.6	8	P6.7

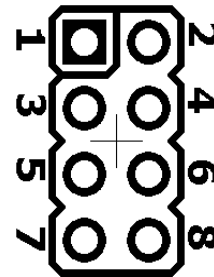

**REF:**

Pin #	Signal Name	Pin #	Signal Name
1	VEREF+	2	VREF+
3	VEREF-	4	GND



# MECHANICAL DIMENSIONS:

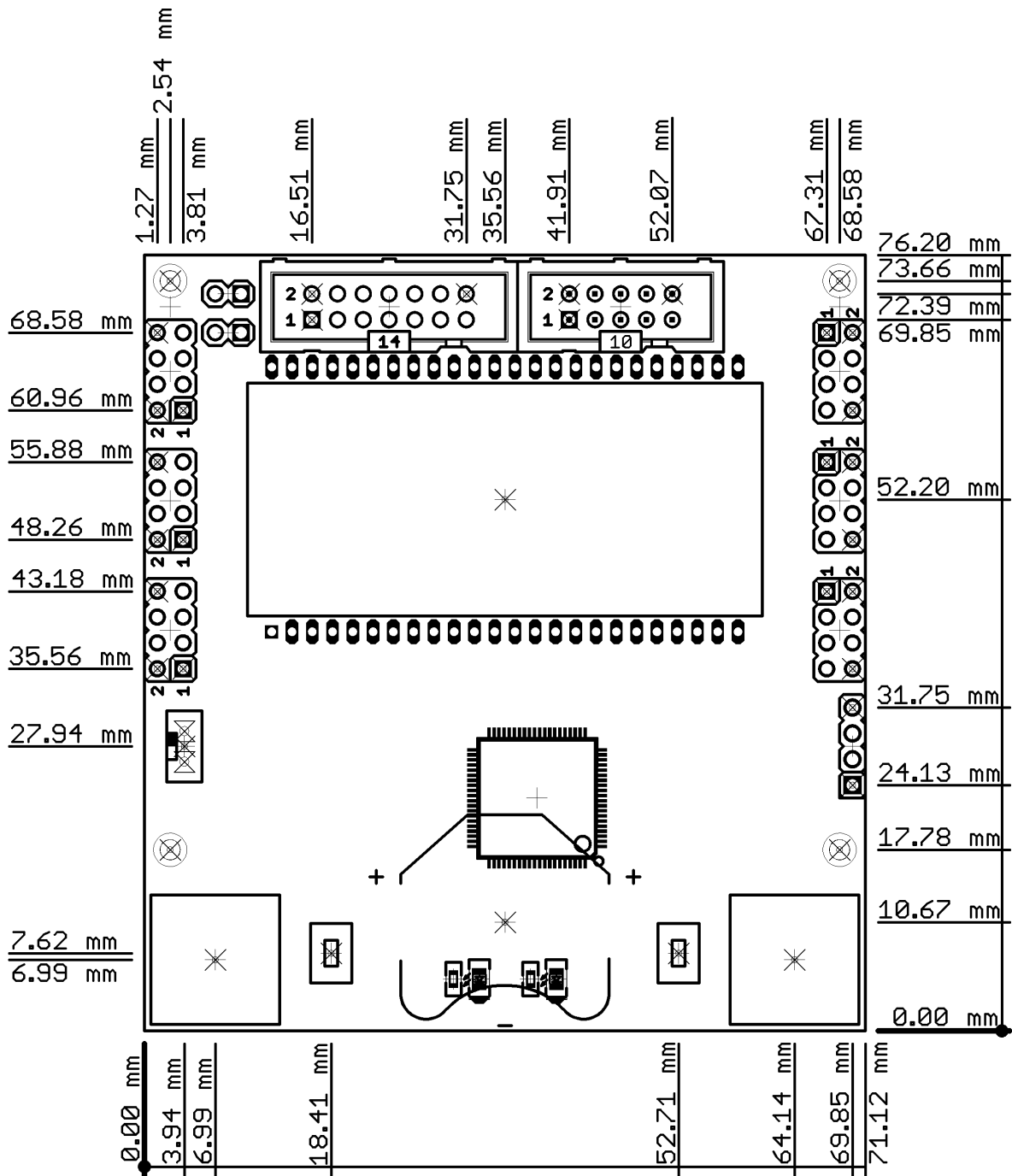



## **AVAILABLE DEMO SOFTWARE:**

1. Example that demonstrates heart rate measuring, using MSP430FG439 microcontroller, requires IAR EW and JTAG tool. Available for download here: [LINK](#)
2. Instructions on connecting MOD-EKG to PC computer with the help of MOD-USB-RS232, available here: [LINK](#)

For more information visit the web-page of the product:

<https://www.olimex.com/Products/Modules/Biofeedback/MOD-EKG/>

## **ORDER CODE:**

**MOD-EKG** – assembled and tested board

## **HOW TO ORDER?**

You can order directly from our web-shop! Please visit our web [www.olimex.com](http://www.olimex.com) for more information.

## **REVISION HISTORY:**

Hardware revision: Rev. B, April 2011

Document revision: Rev. Initial, June 2011

Rev. B, December 2016 – added important note about the main power supply influence over the readings; improved warranty and support information

For product support, hardware information and error reports mail to: [support@olimex.com](mailto:support@olimex.com). All document or hardware feedback is welcome. Note that we are primarily a hardware company and our software support is limited. Please consider reading the paragraph below about the warranty of Olimex products.

All goods are checked before they are sent out. In the unlikely event that goods are faulty, they must be returned, to OLIMEX at the address listed on your order invoice.

OLIMEX will not accept goods that have clearly been used more than the amount needed to evaluate their functionality.

If the goods are found to be in working condition, and the lack of functionality is a result of lack of knowledge on the customers part, no refund will be made, but the goods will be returned to the user at their expense.

All returns must be authorized by an RMA Number. Email [support@olimex.com](mailto:support@olimex.com) for authorization number before shipping back any merchandise. Please include your name, phone number and order number in your email request.

Returns for any unaffected development board, programmer, tools, and cables permitted within 7 days from the date of receipt of merchandise. After such time, all sales are considered final.

Returns of incorrect ordered items are allowed subject to a 10% restocking fee. What is unaffected? If you hooked it to power, you affected it. To be clear, this includes items that have been soldered to, or have had their firmware changed. Because of the nature of the products we deal with (prototyping electronic tools) we cannot allow returns of items that have been programmed, powered up, or otherwise changed post shipment from our warehouse.

All returned merchandise must be in its original mint and clean condition. Returns on damaged, scratched, programmed, burnt, or otherwise 'played with' merchandise will not be accepted.

All returns must include all the factory accessories which come with the item. This includes any In-Circuit-Serial-Programming cables, anti-static packing, boxes, etc.

With your return, enclose your PO#. Also include a brief letter of explanation of why the merchandise is being returned and state your request for either a refund or an exchange. Include the authorization number on this letter, and on the outside of the shipping box.

Please note: It is your responsibility to ensure that returned goods reach us. Please use a reliable form of shipping. If we do not receive your package we will not be held liable.

Shipping and handling charges are not refundable. We are not responsible for any shipping charges of merchandise being returned to us or returning working items to you.

The full text might be found at <https://www.olimex.com/wiki/GTC#Warranty> for future reference.