



Chipsmall Limited consists of a professional team with an average of over 10 year of expertise in the distribution of electronic components. Based in Hongkong, we have already established firm and mutual-benefit business relationships with customers from,Europe,America and south Asia,supplying obsolete and hard-to-find components to meet their specific needs.

With the principle of “Quality Parts,Customers Priority,Honest Operation,and Considerate Service”,our business mainly focus on the distribution of electronic components. Line cards we deal with include Microchip,ALPS,ROHM,Xilinx,Pulse,ON,Everlight and Freescale. Main products comprise IC,Modules,Potentiometer,IC Socket,Relay,Connector.Our parts cover such applications as commercial,industrial, and automotives areas.

We are looking forward to setting up business relationship with you and hope to provide you with the best service and solution. Let us make a better world for our industry!



Contact us

Tel: +86-755-8981 8866 Fax: +86-755-8427 6832

Email & Skype: info@chipsmall.com Web: www.chipsmall.com

Address: A1208, Overseas Decoration Building, #122 Zhenhua RD., Futian, Shenzhen, China



Power Amplifier



FEATURES

- Low Cost Integrated Solution
- Output Current > 10A within SOA
- Internal Power Dissipation 35W Per Channel
- 167V/μs Slew Rate

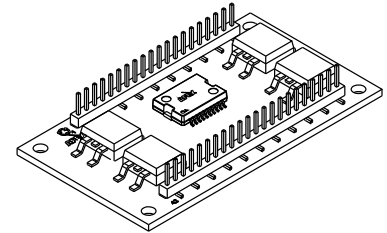

APPLICATIONS

- Piezoelectric Actuation For Ink Jet Printer Nozzles

DESCRIPTION

The MP103 is a high voltage, high output current dual channel operational amplifier for driving capacitive loads such as piezo devices use in ink jet printing applications. The MP103 utilizes proprietary IC's combined with discrete semiconductor and passive elements on a thermally conductive insulated metal substrate, delivering very high power from a compact module. The amplifier gain is fixed at 65 V/V when the feedback pin is connected to the V_{OUT} pin. Internal compensation provides optimum slew rate and ensures stability. The only external components required are the current limit resistors R_{LIM} , a series isolation resistor R_S (when driving a capacitive load) and the power supply bypass capacitors.

Figure 1: Equivalent Schematic

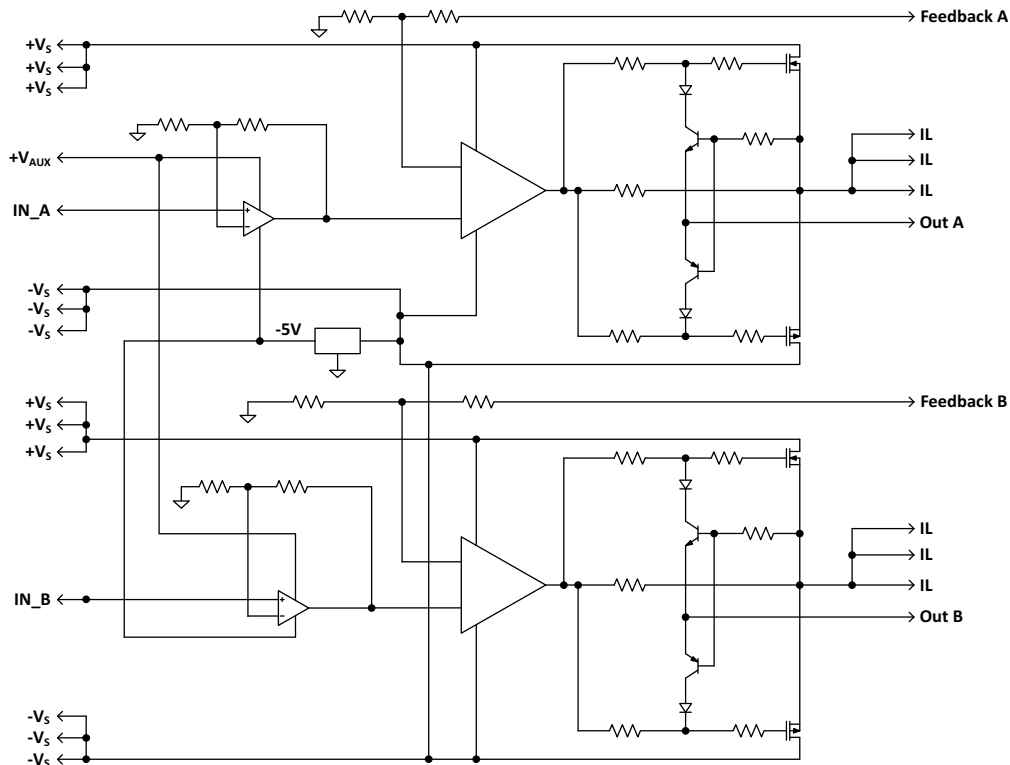

TYPICAL CONNECTION

Figure 2: Typical Connection

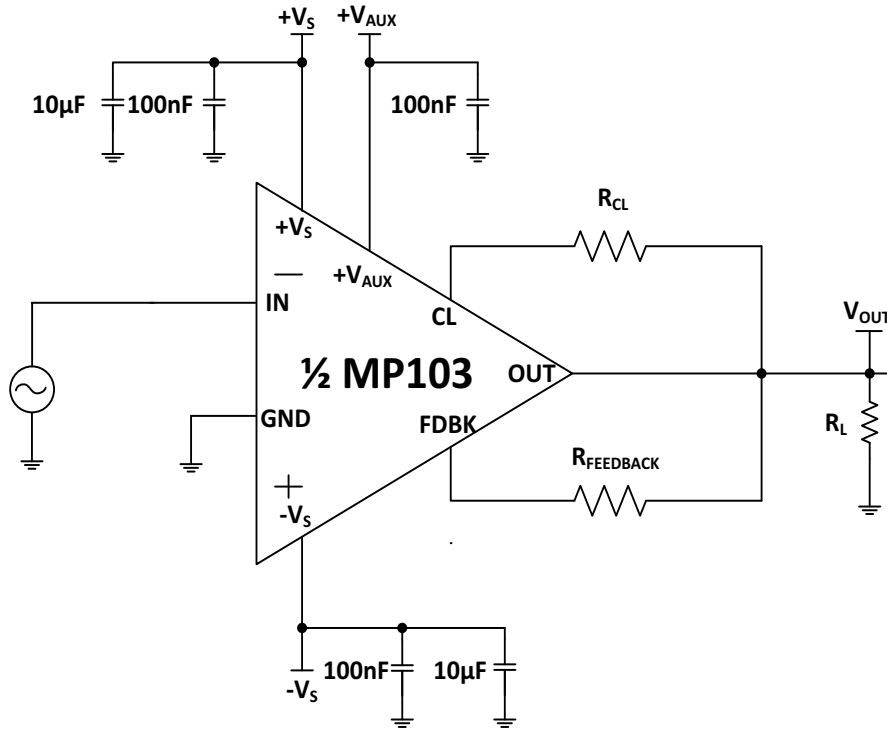

PINOUT AND DESCRIPTION TABLE

Figure 3: External Connections

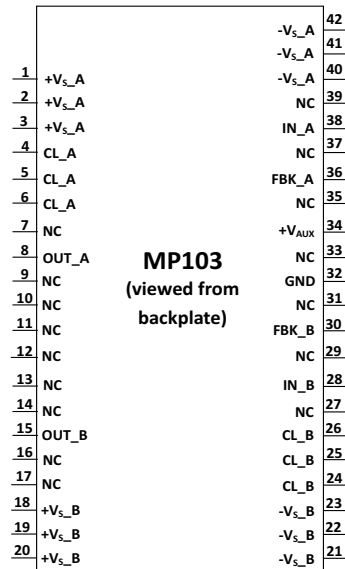

Pin Number	Name	Description
1, 2, 3	+Vs_A	The positive supply rail for channel A.
4, 5, 6	CL_A	Connect to the current limit resistor. Output current flows into/out of these pins through R _{CL} . The output pin and the load are connected to the other side of R _{CL} .
8	OUT_A	The output for channel A. Connect this pin to load and to the feedback resistor.
15	OUT_B	The output for channel B. Connect this pin to load and to the feedback resistor.
18, 19, 20	+Vs_B	The positive supply rail for channel B.
21, 22, 23	-Vs_B	The negative supply rail for channel B. Internally connected to -Vs_A.
24, 25, 26	CL_B	Connect to the current limit resistor. Output current flows into/out of these pins through R _{CL} . The output pin and the load are connected to the other side of R _{CL} .
28	IN_B	The input for channel B.
30	FBK_B	The feedback pin for channel B. This pin must be connected to OUT_B to close the feedback loop. When connected directly to OUT_B the closed loop voltage gain of channel B is 65 V/V. The gain can be increased by inserting a 1/4 W resistor between FBK_B and OUT_B.
32	GND	Ground.
34	Vaux	+24 V power supply pin. A 24 V supply is required for operation of front end small signal circuitry.
36	FBK_A	The feedback pin for channel A. This pin must be connected to OUT_A to close the feedback loop. When connected directly to OUT_A the closed loop voltage gain of channel A is 65 V/V. The gain can be increased by inserting a 1/4 W resistor between FBK_A and OUT_A.
38	IN_A	The input for channel A.
40, 41, 42	-Vs_A	The negative supply rail for channel A. Internally connected to -Vs_B.
All Others	NC	No connection.

ELECTRICAL SPECIFICATIONS

- Notes:**
- a) All Min/Max characteristics and specifications are guaranteed over the Specified Operating Conditions. Typical performance characteristics and specifications are derived from measurements taken at typical supply voltages and $T_C = 25^\circ\text{C}$.
 - b) $+V_S$ and $-V_S$ denote the positive and negative supply voltages to the output stages. $+V_{AUX}$ denotes the positive supply voltage to the input stages.

ABSOLUTE MAXIMUM RATINGS

Parameter	Symbol	Min	Max	Unit
Supply Voltage, $+V_S$ to $-V_S$	$+V_S$ to $-V_S$		200	V
Supply Voltage, $-V_S$	$-V_S$	-30		V
Supply Voltage, $+V_{AUX}$	$+V_{AUX}$		30	V
Output Current, pk, per Channel (Within SOA)	$I_{O(PK)}$		15	A
Power Dissipation, internal, Each Channel	P_D		35	W
Input Voltage	V_{IN}	-5	V_{AUX}	V
Temperature, pin solder, 10s			225	$^\circ\text{C}$
Temperature, junction ¹	T_J		150	$^\circ\text{C}$
Temperature Range, storage		-40	105	$^\circ\text{C}$

1. Long term operation at the maximum junction temperature will result in reduced product life. Derate power dissipation to achieve high MTTF.

INPUT

Parameter	Test Conditions	Min	Typ	Max	Unit
Offset Voltage		-6.7	± 2	6.7	mV
Offset Voltage vs. Temperature	Full temp range		± 2		$\mu\text{V}/^\circ\text{C}$
Bias Current, initial ¹		-6.6	± 3.3	6.6	μA

1. Doubles for every 10°C of case temperature increase.

GAIN

Parameter	Test Conditions	Min	Typ	Max	Unit
Fixed Gain	Feedback connected to V_{OUT}	63.5	65	66.5	V/V
Gain Bandwidth, -3db	$C_L = 47\text{nF}$		230		kHz
Power Bandwidth, 130 V_{p-p}	$+V_S = 145\text{V}$, $-V_S = -15\text{V}$		230		kHz

OUTPUT

Parameter	Test Conditions	Min	Typ	Max	Unit
Voltage Swing	$I_O = 10A$	$+V_S - 15$	$+V_S - 9$		V
Voltage Swing	$I_O = 10A$	$-V_S + 15$	$-V_S + 14$		V
Current, Peak, Source			12		A
Slew Rate	$R_S = 1 \Omega$, $C_L = 47nF$, $V_{in} \geq 8V_{p-p}$	167			V/ μs

POWER SUPPLY

Parameter	Test Conditions	Min	Typ	Max	Unit
Voltage, $-V_S$		-7	-15	-20	V
Voltage, $+V_{AUX}$			24	25	V
Voltage, $+V_S$		$-V_S + 20$	145	$-V_S + 200$	V
Current, quiescent, $-V_S$			19	26	mA
Current, quiescent, $+V_{AUX}$			13.5	15	mA
Current, quiescent, $+V_S$			1	5	mA

THERMAL

Parameter	Test Conditions	Min	Typ	Max	Unit
Resistance, AC, junction to case ¹	Full temp range, $f \geq 60$ Hz		1.5	1.75	$^{\circ}C/W$
Resistance, DC, junction to case	Full temp range, $f < 60$ Hz		3.1	3.6	$^{\circ}C/W$
Resistance, junction to air	Full temp range		12.5	14	$^{\circ}C/W$
Temperature Range, case		0		70	$^{\circ}C$

1. Rating applies if the output current alternates between both output transistors at a rate faster than 60 Hz.

TYPICAL PERFORMANCE GRAPHS

Figure 4: Power Derating

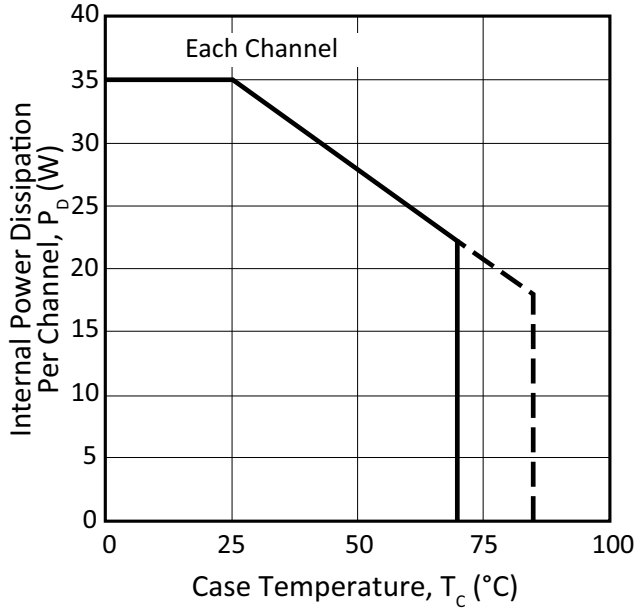

Figure 5: Output Voltage Swing

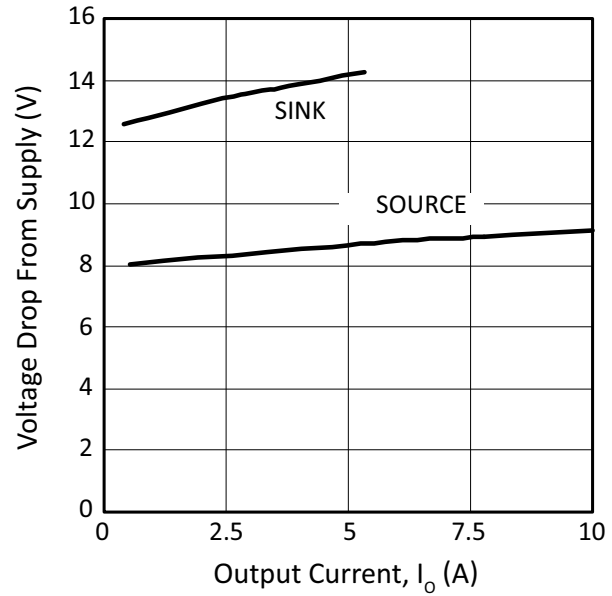

Figure 6: Frequency Response

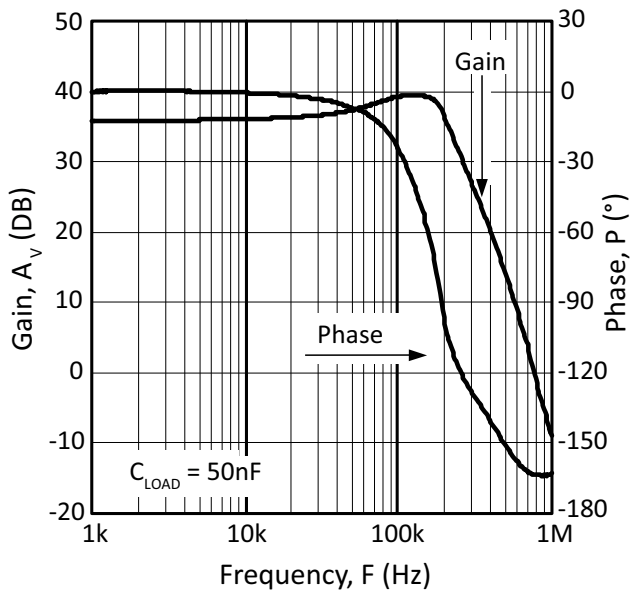

Figure 7: Quiescent Current

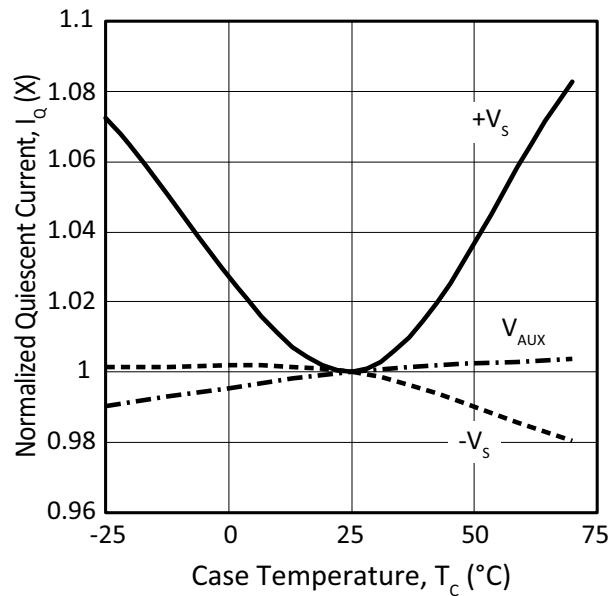

Figure 8: Offset Voltage vs. Temperature

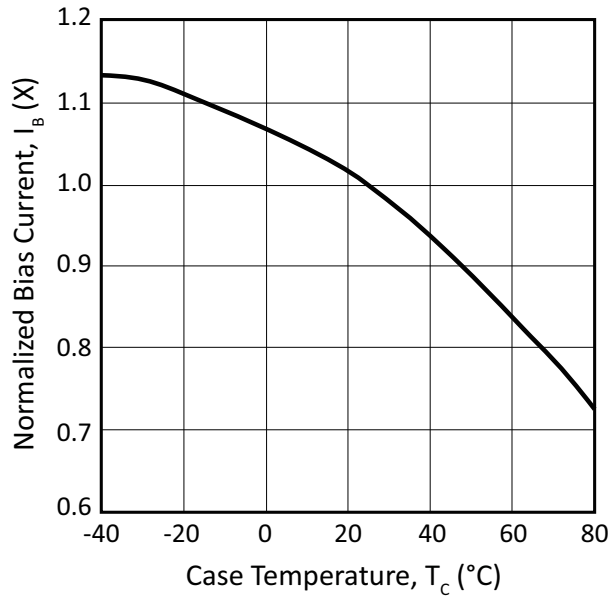

Figure 9: Max. DC Output Voltage

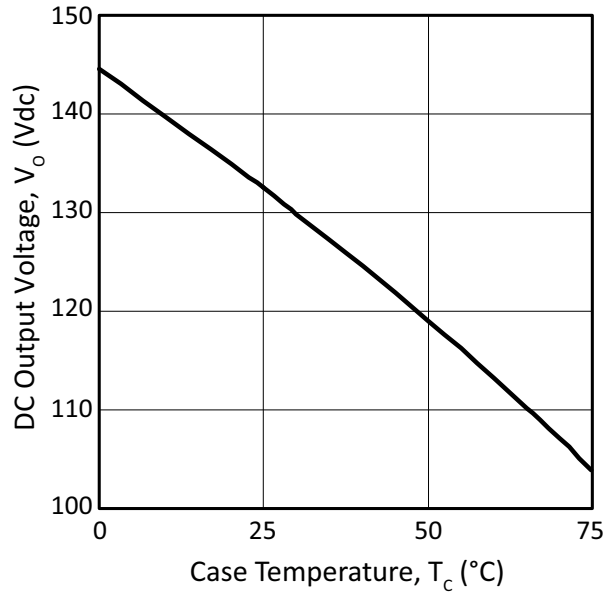

Figure 10: Max. Output Pulse Duty Cycle

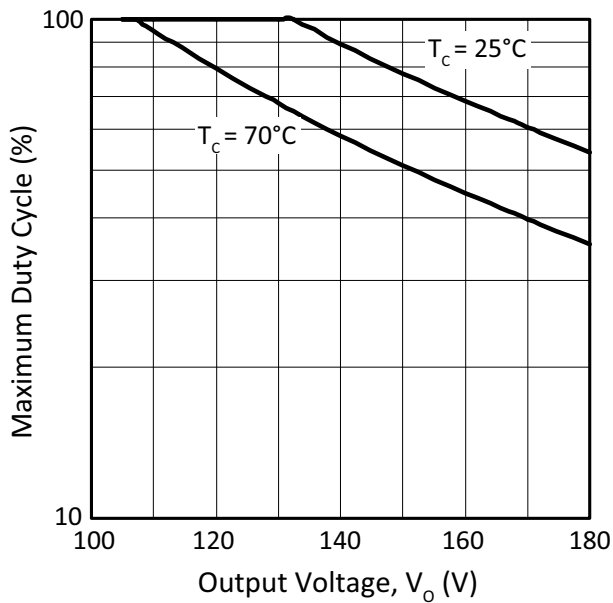

Figure 11: Input Bias Current vs. Temperature

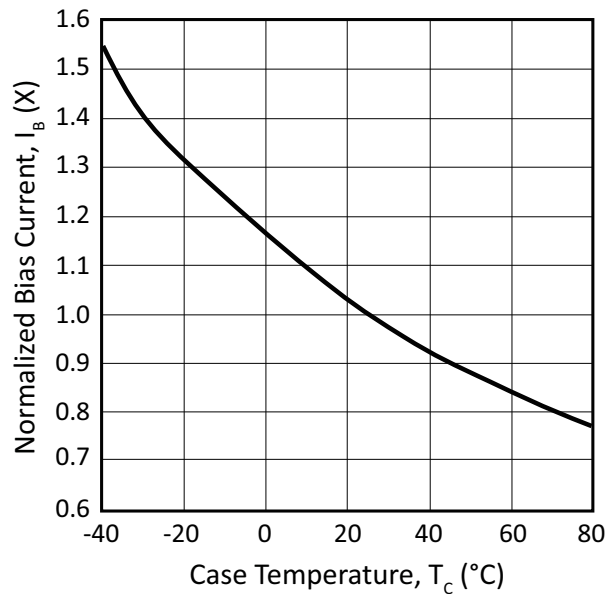

Figure 12: Offset Voltage vs. V_S Supply

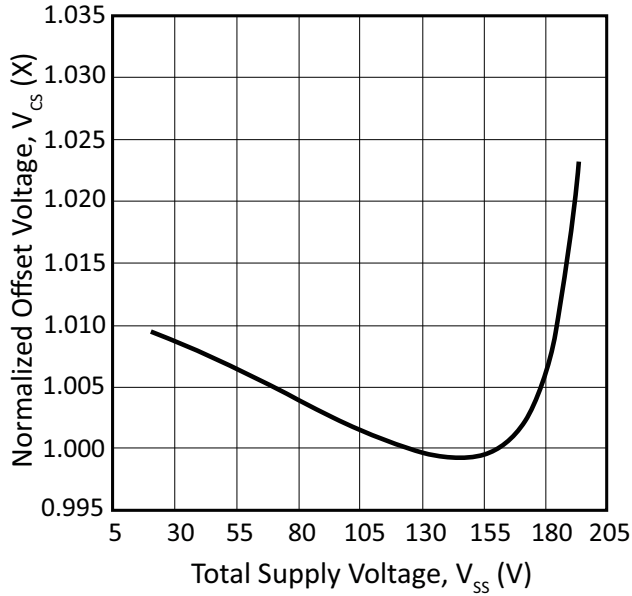

Figure 13: Offset Voltage vs. V_{Aux} Supply

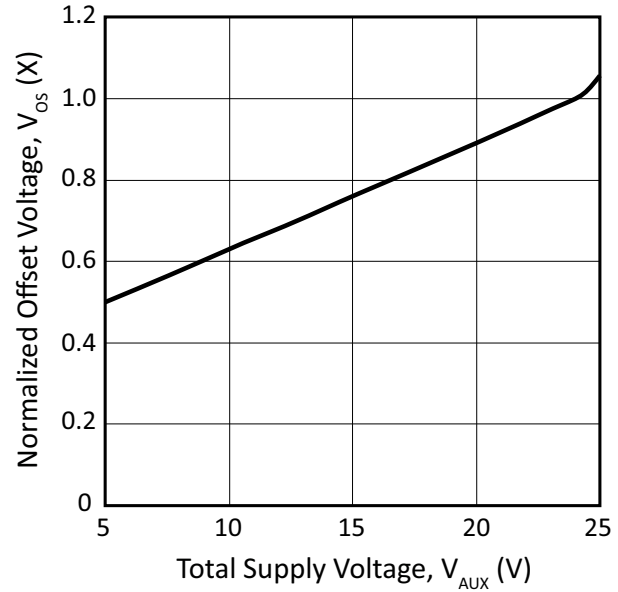

Figure 14: Input Bias Current vs. V_{Aux} Supply

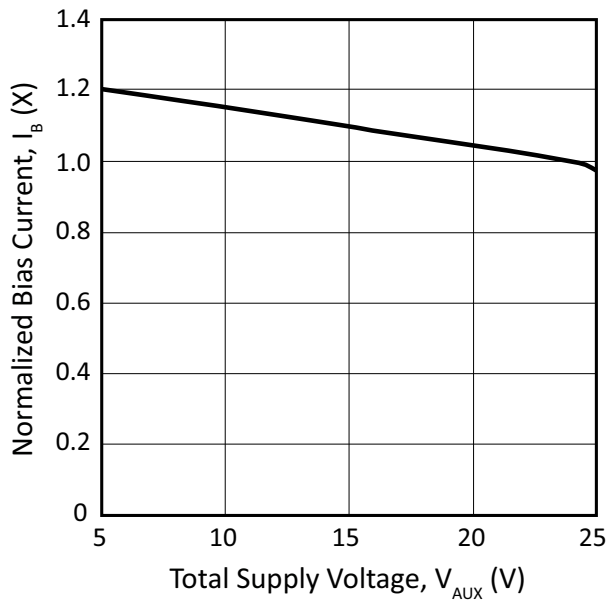

Figure 15: Input Bias Current vs. V_{SS} Supply

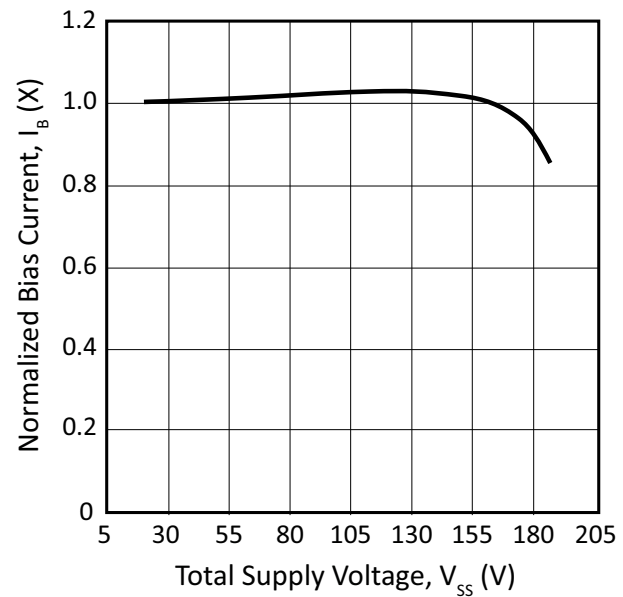

Figure 16: Amplifier Gain vs. R_{FDBK}

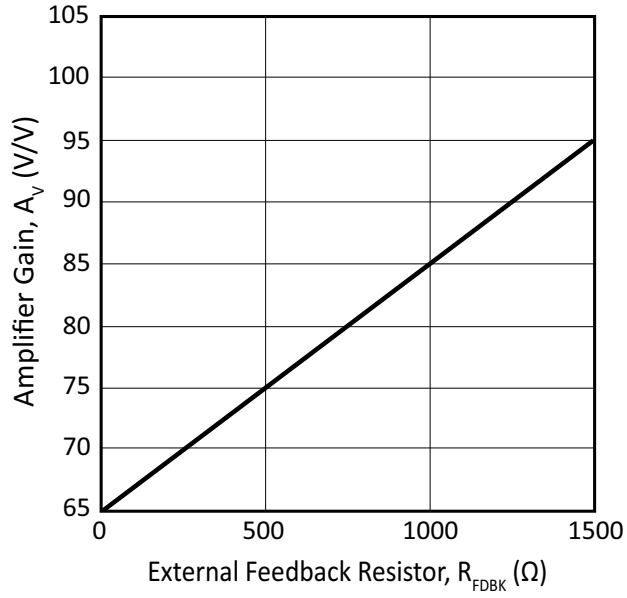
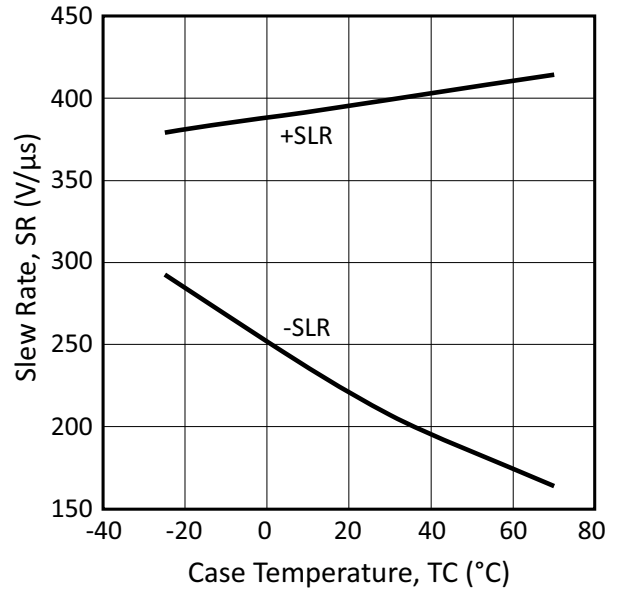

Figure 17: Slew Rate vs. Temperature



SAFE OPERATING AREA (SOA)

The MOSFET output stage of the MP103 is not limited by second breakdown considerations as in bipolar output stages. Only thermal considerations and current handling capabilities limit the SOA (see Safe Operating Area graph). The output stage is protected against transient flyback by the parasitic body diodes of the output stage MOSFET structure. However, for protection against sustained high energy flyback, external fast-recovery diodes must be used.

Figure 18: SOA

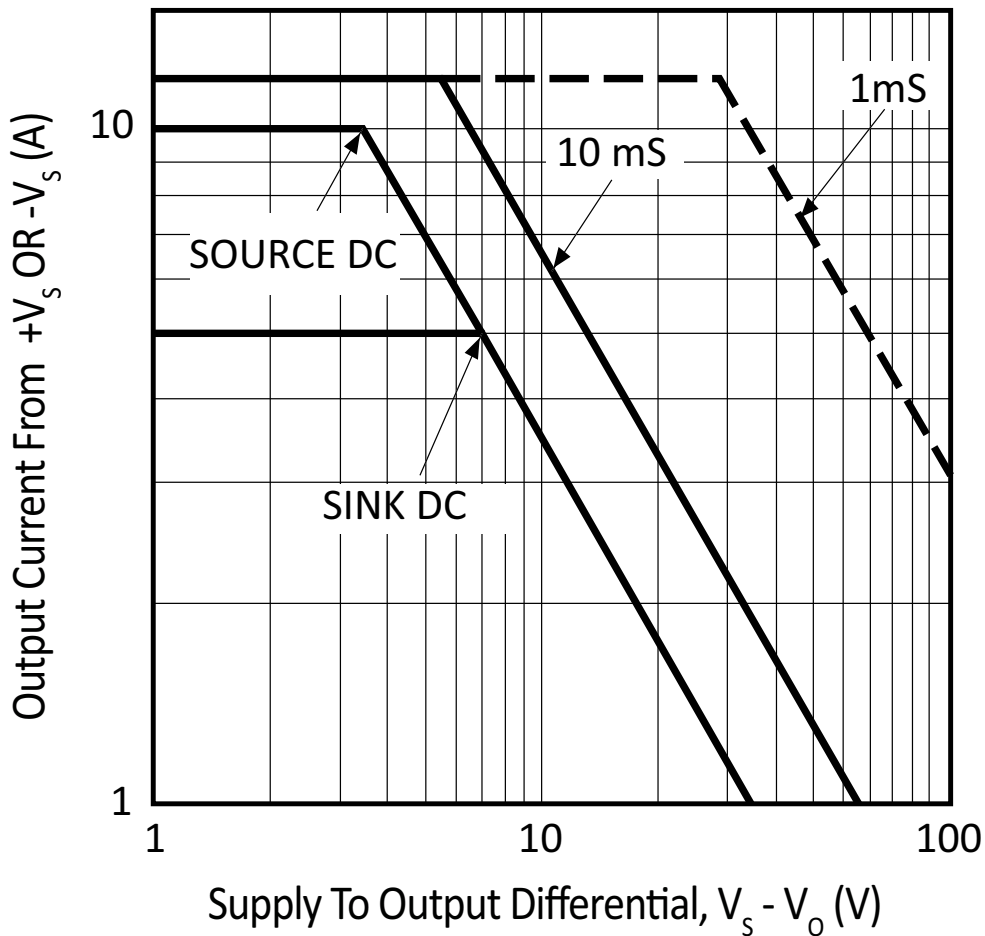

GENERAL

Please read Application Note 1 “General Operating Considerations” which covers stability, supplies, heat sinking, mounting, current limit, SOA interpretation, and specification interpretation. Visit www.apexanalog.com for Apex Microtechnology’s complete Application Notes library, Technical Seminar Workbook, and Evaluation Kits.

AMPLIFIER GAIN

When the feedback pin for each channel is connected to the corresponding OUT pin, the gain of the amplifier is internally set to 65 V/V. The amplifier gain can be increased by connecting a resistor between the feedback and Out pin. The amplifier gain will be increased approximately 1 V/V for each additional 49.9 Ω added between the feedback and OUT pin.

POWER SUPPLY BYPASSING

Bypass capacitors to power supply terminals +V_S and -V_S must be connected physically close to the pins to prevent local parasitic oscillation in the output stage of the MP103. Use electrolytic capacitors at least 10 μ F per output amp required. Bypass the electrolytic capacitors with high quality ceramic capacitors (X7R) 0.1 μ F or greater. Duplicate the supply bypass for the supply terminals of each amplifier channel. A bypass capacitor of 0.1 μ F or greater is recommended for the +V_{AUX} terminal.

CURRENT LIMIT

For proper operation, the current limit resistor (R_{LIM}) must be connected as shown in the external connection diagram. For optimum reliability the resistor value should be set as high as possible. The value is calculated as follows; with the maximum practical value of 30 Ω . The current limit function can be disabled by shorting the I_L pin to the OUT pin.

$$R_{LIM} = \frac{0.7V}{I_{LIM}}$$

POWER SUPPLY PROTECTION

Unidirectional zener diode transient suppressors are recommended as protection on the supply pins. The zeners clamp transients to voltages within the power supply rating and also clamp power supply reversals to ground. Whether the zeners are used or not, the system power supply should be evaluated for transient performance including power-on overshoot and power-off polarity reversal as well as line regulation. Conditions which can cause open circuits or polarity reversals on either power supply rail should be avoided or protected against. Reversals or opens on the negative supply rail is known to induce input stage failure. Unidirectional transzorbs prevent this, and it is desirable that they be both electrically and physically as close to the amplifier as possible.

SERIES ISOLATION RESISTOR, R_S

To insure stability with all capacitive loads a series isolation resistor should be included between the output and the load as shown in the external connections drawing. A 1 Ω resistor works well for capacitive loads between 135pF and 44nF. The resistor will affect the rise and fall time of the output pulse at the capacitive load. This can be compensated for on the input signal.

BACKPLATE GROUNDING

The substrate of the MP103 is an insulated metal substrate. It is required that it be connected to signal ground. This is accomplished when the ground pin (Pin 32) is properly connected to signal ground.

