



Chipsmall Limited consists of a professional team with an average of over 10 year of expertise in the distribution of electronic components. Based in Hongkong, we have already established firm and mutual-benefit business relationships with customers from,Europe,America and south Asia,supplying obsolete and hard-to-find components to meet their specific needs.

With the principle of “Quality Parts,Customers Priority,Honest Operation,and Considerate Service”,our business mainly focus on the distribution of electronic components. Line cards we deal with include Microchip,ALPS,ROHM,Xilinx,Pulse,ON,Everlight and Freescale. Main products comprise IC,Modules,Potentiometer,IC Socket,Relay,Connector.Our parts cover such applications as commercial,industrial, and automotives areas.

We are looking forward to setting up business relationship with you and hope to provide you with the best service and solution. Let us make a better world for our industry!



Contact us

Tel: +86-755-8981 8866 Fax: +86-755-8427 6832

Email & Skype: info@chipsmall.com Web: www.chipsmall.com

Address: A1208, Overseas Decoration Building, #122 Zhenhua RD., Futian, Shenzhen, China



DESCRIPTION

The MP1906 is a high-performance, 80V, gate driver that can drive two external N-MOSFETs in a half-bridge configuration with a 12V gate supply. It accepts independent gate input signals and provides shoot-through prevention. During under-voltage lockout, the output of the high- and low-side drivers goes low to prevent erratic operation under low supply conditions.

The high-current driving capability and short dead time make it suitable for high-power and high-efficiency power applications, such as telecom DC-DC converters. The compact 8-pin SOIC package minimizes the component count and the board space.

FEATURES

- Drives Two Low-Cost, High-Efficiency N-MOSFETs
- 10V-16V Gate Drive Supply
- 3.3V, 5V Logic Compatibility
- 80ns Propagation Delay
- Less than 90µA Quiescent Current
- Under-Voltage Lockout for Both Channels
- Input-Signal-Overlap Protection
- Internal 150ns Dead Time
- Available in a Compact 8-pin SOIC Package

APPLICATIONS

- Motor Drivers
- Half-Bridge Power Supplies
- Avionics DC-DC Converters
- Active-Clamp Forward Converters

All MPS parts are lead-free and adhere to the RoHS directive. For MPS green status, please visit MPS website under Products, Quality Assurance page.

"MPS" and "The Future of Analog IC Technology" are registered trademarks of Monolithic Power Systems, Inc.

TYPICAL APPLICATION

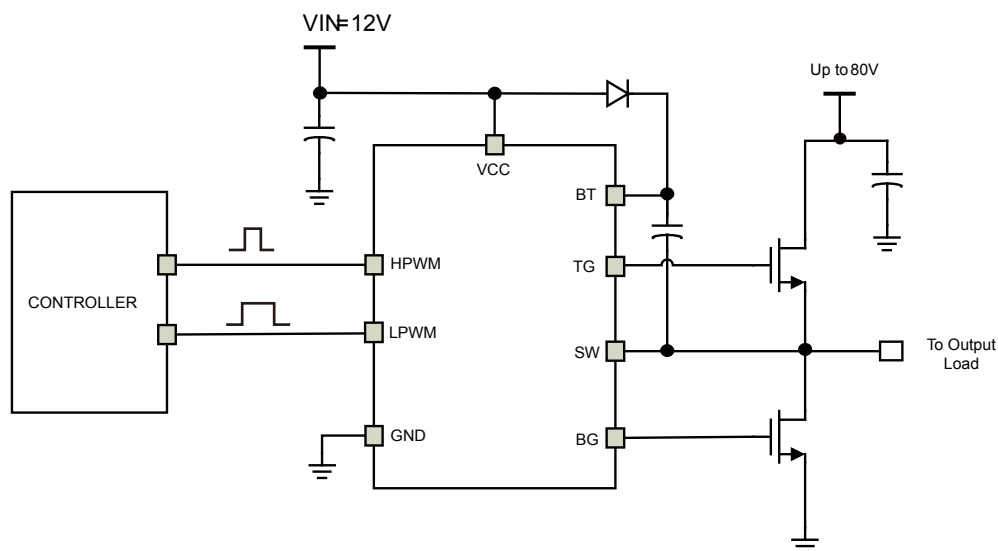

ELECTRICAL CHARACTERISTICS

$V_{CC} = 12V$, $V_{SW}=0V$, no load on TG or BG, $T_A = 25^\circ C$, unless otherwise noted.

Parameter	Symbol	Condition	Min	Typ	Max	Units
Supply Current						
V_{CC} quiescent current	I_{CCQ}	$V_{LPWM}=5V$, $V_{HPWM}=0V$	70	90	110	μA
V_{CC} operation current	I_{CC}	$f=50kHz$, $C_{LOAD\ BG}=1nF$		0.9	1.5	mA
Bootstrap quiescent current	I_{BTQ}	$V_{LPWM}=5V$, $V_{HPWM}=0V$		30		μA
Bootstrap operation current	I_{BT}	$f=50kHz$, $C_{LOAD\ TG}=1nF$		0.7	1	mA
SW BT leakage current	I_{LK}	$V_{SW}=V_{BT}=80V$		0.1	0.5	μA
Input						
LPWM falling threshold	V_{LPWMF}				0.8	V
LPWM rising threshold	V_{LPWMR}		2.5			V
HPWM falling threshold	V_{HPWMF}				0.8	V
HPWM rising threshold	V_{HPWMR}		2.5			V
Under-Voltage Protection (UVLO)						
V_{CC} rising threshold	V_{CCTHR}		8.2	8.8	9.4	V
V_{CC} threshold hysteresis	V_{CCTHH}			0.7		V
Bootstrap rising threshold	V_{BTTHR}		4.5	5.5	6.5	V
Bootstrap threshold hysteresis	V_{BTTHH}			0.65		V
Gate Driver Output						
Low-side gate pull-up peak current ⁽⁵⁾	I_{BGU}	$V_{BG}=0V$		350		mA
Low-side gate pull-down peak current ⁽⁵⁾	I_{BGD}	$V_{BG}=12V$		1		A
High-side gate pull-up peak current ⁽⁵⁾	I_{TGU}	$V_{TG}=0V$		350		mA
High-side gate pull-down peak current ⁽⁵⁾	I_{TGD}	$V_{TG}=12V$		1		A
Propagation Delays, Dead Times and Output Rising and Falling Times ($C_{Load}=1nF$ cap) (please see timing diagram)						
Turn-on propagation delay (TG)	$\tau_{ON\ TG}$	$V_{SW}=0V$		80	150	ns
Turn-off propagation delay (TG)	$\tau_{OFF\ TG}$	$V_{SW}=0V$		80	150	ns
Turn-on rise time (TG)	$\tau_{RISE\ TG}$			50	100	ns
Turn-off fall time (TG)	$\tau_{FALL\ TG}$			30	100	ns
Turn-on propagation delay (BG)	$\tau_{ON\ BG}$			80	150	ns
Turn-off propagation delay (BG)	$\tau_{OFF\ BG}$			80	150	ns
Turn-on rise time (BG)	τ_{RISE_BG}			50	100	ns
Turn-off fall time (BG)	τ_{FALL_BG}			30	100	ns
Deadtime, LS turn-off to HS turn-on & HS turn-on to LS turn-off	τ_{DT}			150	250	ns

ELECTRICAL CHARACTERISTICS(CONTIUUED)
 $V_{CC} = 12V$, $V_{SW}=0V$, no load on TG or BG, $T_A = 25^\circ C$, unless otherwise noted.

Parameter	Symbol	Condition	Min	Typ	Max	Units
LPWM source current	I_{LPWM}	$I_{LPWM}=5V$	-8	-3	-1	μA
HPWM sink current	I_{HPWM}	$I_{HPWM}=5V$	1	3	8	μA
Floating Gate Driver						
BG-output-low to GND	V_{BGL}	$I_{BG}=100mA$		0.4	0.7	V
BG-output-high to rail	V_{BGH}	$I_{BG}=-100mA$, $V_{BGH}=V_{CC}-V_{BG}$		1.5	1.7	V
TG-output-low to SW	V_{TGL}	$I_{TG}=100mA$		0.4	0.7	V
TG-output-high to rail	V_{TGH}	$I_{TG}=-100mA$, $V_{TGH}=V_{CC}-V_{TG}$		1.5	1.7	V
Switching Specifications						
Minimum input pulse width to change the output ⁽⁵⁾	τ_{PWM_min}				50	ns

Notes:

5) Guaranteed by design

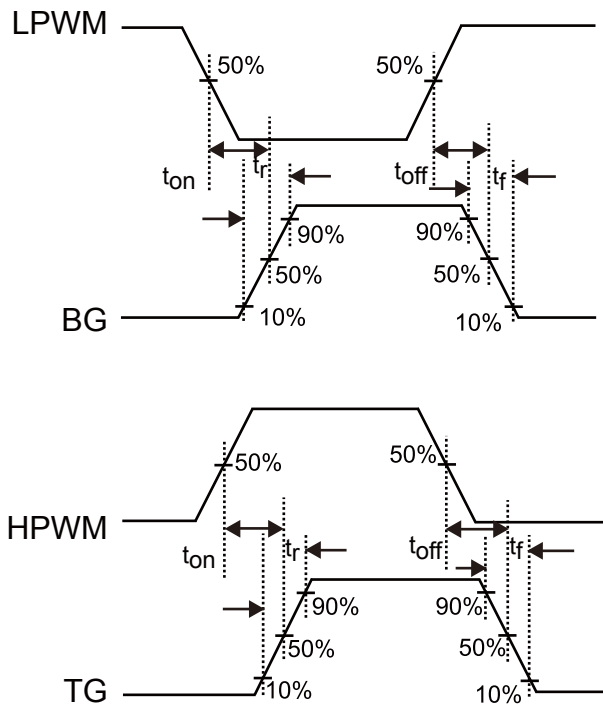
Figure 1: Gate Driver Timing Diagram

TYPICAL CHARACTERISTICS

$V_{DD}=12V, V_{SW}=0V, T_A=+25^{\circ}C$, unless otherwise noted.

High Level Output Voltage vs. Temperature

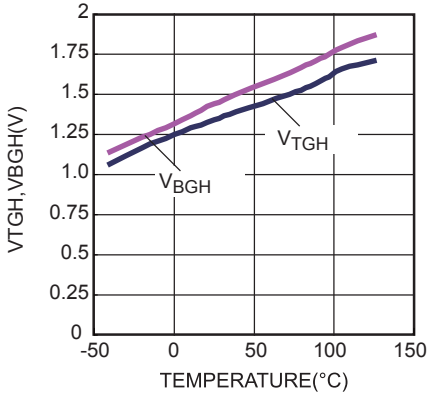

Low Level Output Voltage vs. Temperature

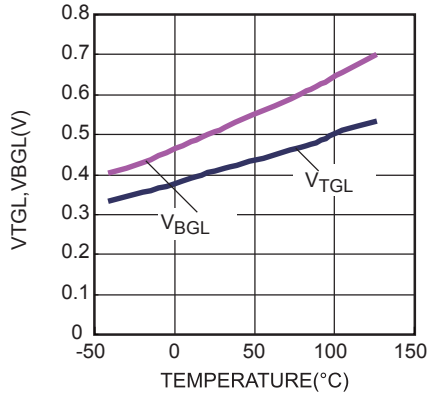

Undervoltage Lockout Threshold vs. Temperature (Rising)

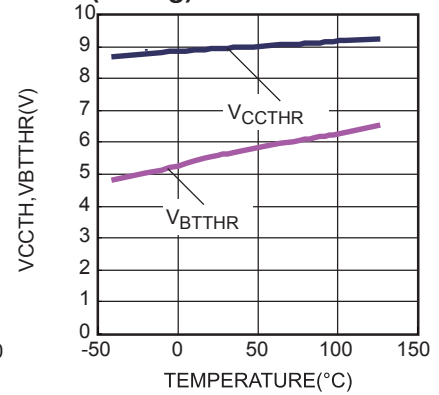

Undervoltage Lockout Threshold vs. Temperature (Falling)

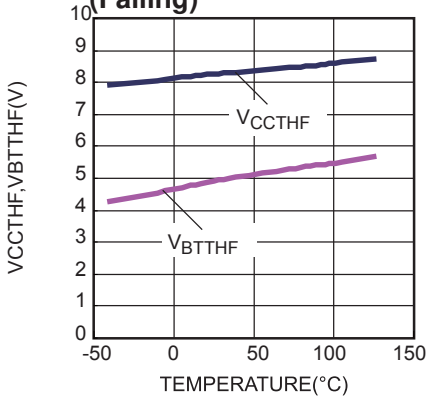

Undervoltage Lockout Hysteresis vs. Temperature

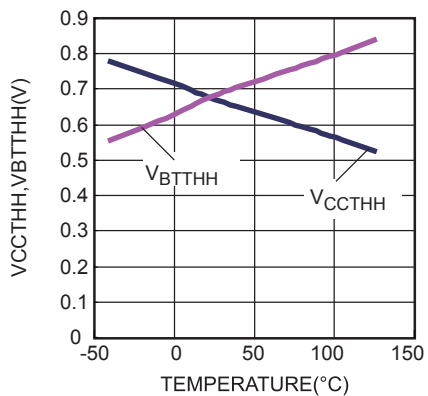

Propagation Delay vs. Temperature

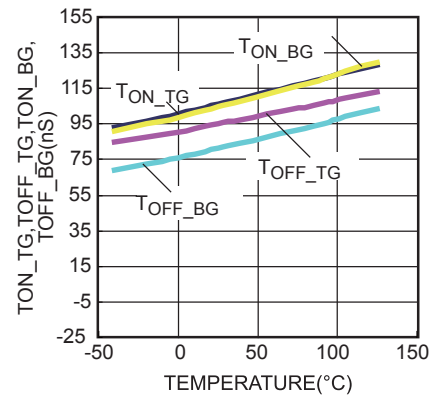

Quiescent Current vs. Temperature

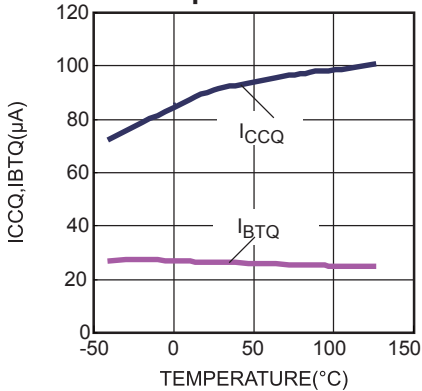

TYPICAL PERFORMANCE CHARACTERISTICS

$V_{CC} = 12V$, $V_{SW} = 0V$, 1nF load on TG and BG, $T_A = 25^\circ C$, unless otherwise noted.

Turn-on Propagation Delay

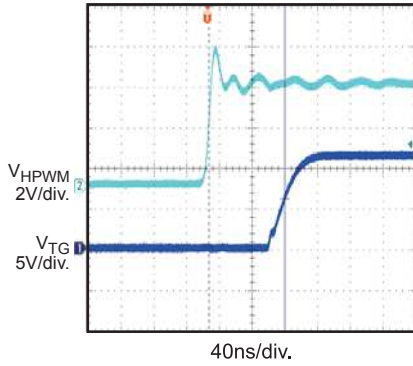

Turn-on Propagation Delay

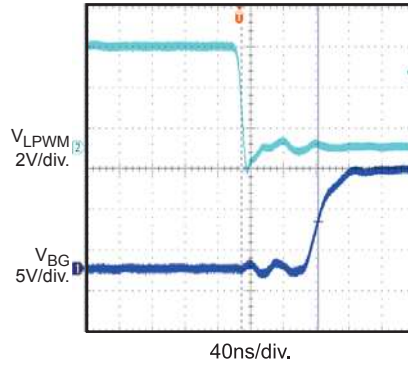

Turn-off Propagation Delay

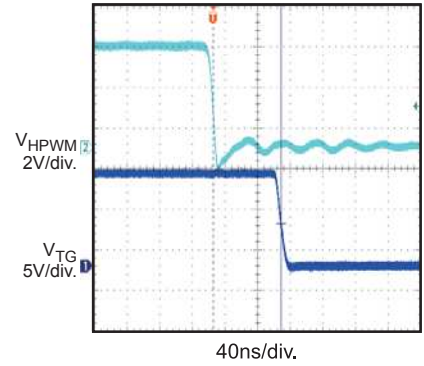

Turn-off Propagation Delay

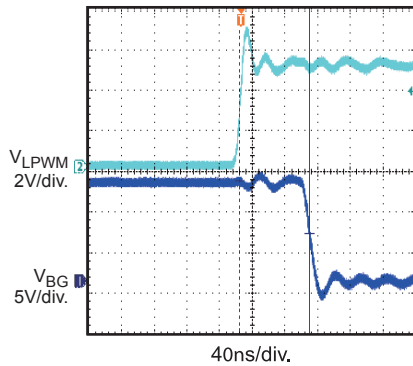

Drive Rise Time(1nF Load)

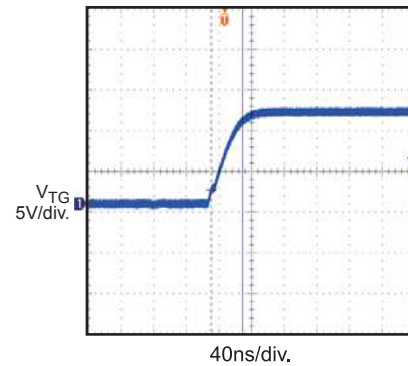

Drive Rise Time(1nF Load)

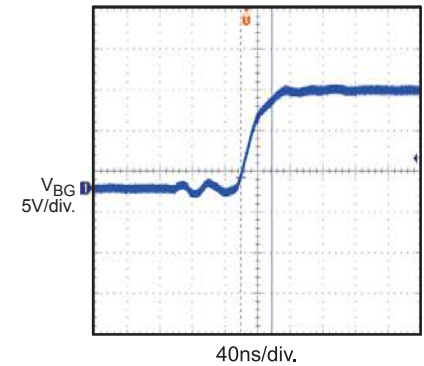

Drive Fall Time(1nF Load)

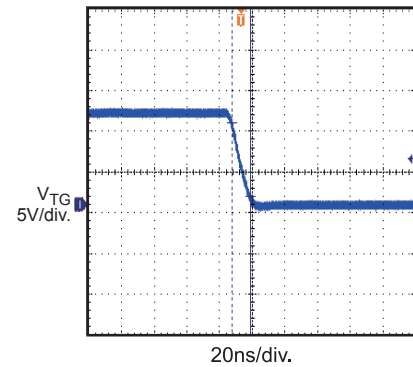

Drive Fall Time(1nF Load)

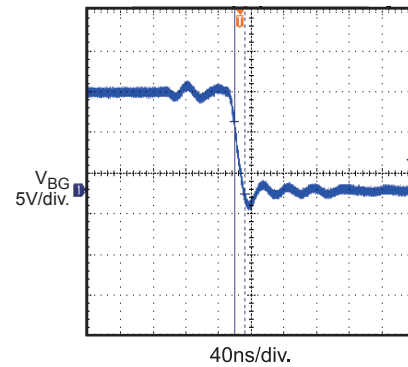

Input Signal Overlap Protection

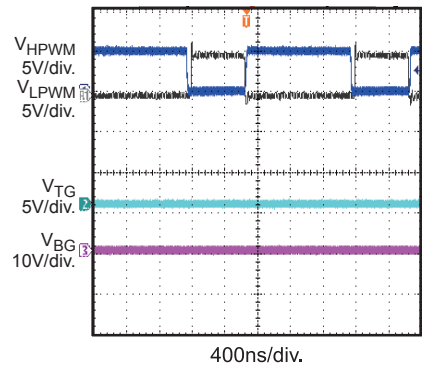

PIN FUNCTIONS

Pin #	Name	Description
1	VCC	Supply Input. Supplies power to all internal circuitry. Requires a decoupling capacitor to ground placed close to this pin to ensure a stable and clean supply.
2	HPWM	Logic input for high-side gate driver output.
3	LPWM	Logic input for low-side gate driver output. Active low.
4	GND	Ground.
5	BG	Gate Driver Output for low-side MOSFET.
6	SW	Source Return for high-side MOSFET.
7	TG	Gate Driver Output for high-side MOSFET.
8	BT	Bootstrap. Internal power supply pin for high-side floating driver. Add a 1 μ F ceramic bootstrap capacitor from BT to SW pin.

FUNCTIONAL BLOCK DIAGRAM

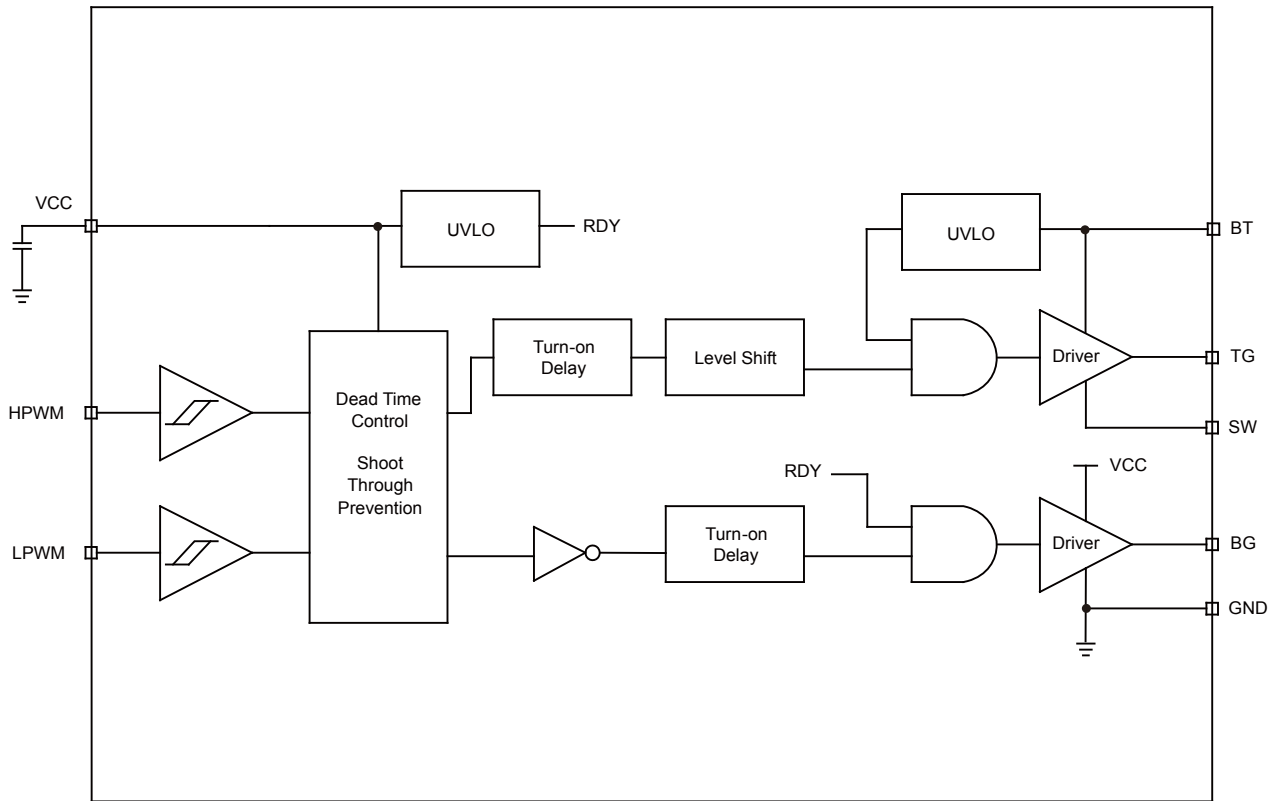

Figure 2: Functional Block Diagram

OPERATION

Switch Shoot-through Protection

The input signals of HPWM and LPWM are independently controlled. Input shoot-through protection circuitry prevents shoot-through between the TG and BG outputs. Only one of the FET drivers can be on at one time. If HPWM is high and LPWM is low, both TG and BG are OFF.

Under Voltage Lockout

When V_{CC} or V_{BT} goes below their respective UVLO threshold, both BG and TG outputs will go low to both FETS. Once V_{CC} and V_{BT} rises above the UVLO threshold, both TG and BG will stay low until there is a rising edge on either HPWM or LPWM.

Figure 3 shows the operation of the TG and BG under different HPWM and LPWM and UVLO conditions.

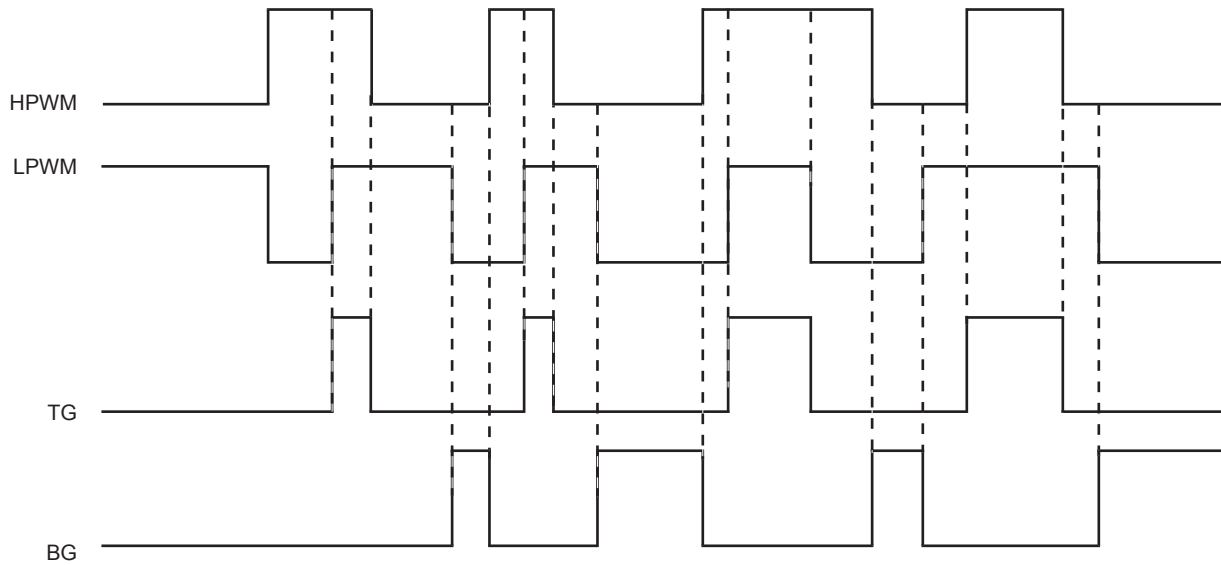

Figure 3: Input/Output Timing Diagram

APPLICATION INFORMATION

Reference Design Circuits Half Bridge Motor Driver

In a half-bridge converter topology, the MOSFET-driving signals have a dead time: HPWM and LPWM driven with alternating signals from the

PWM controller. The input voltage can be up to 80V in this application.

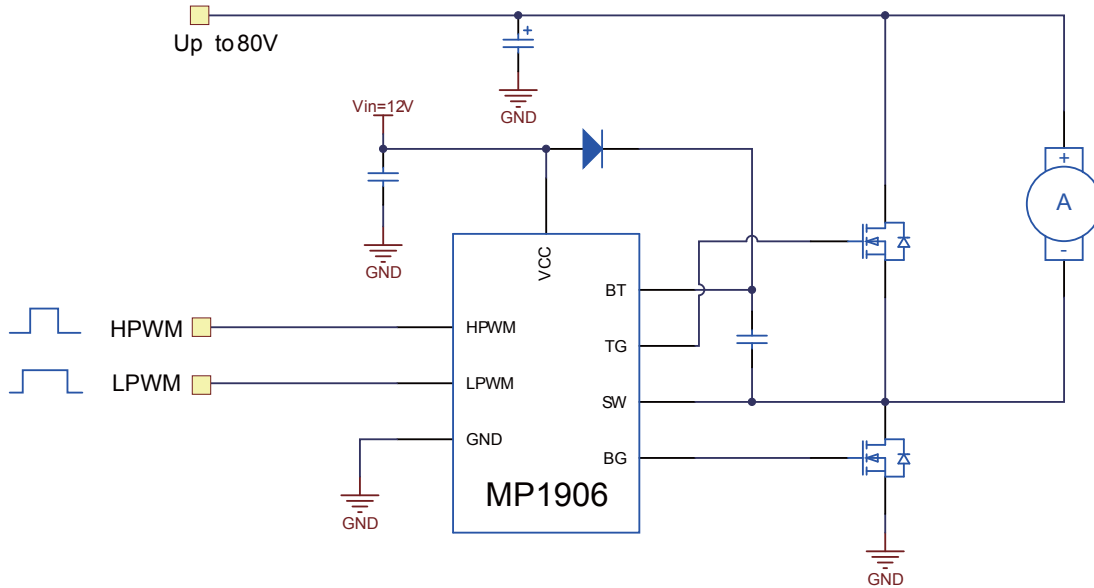

Figure 4: Half-Bridge Motor Driver

Active-Clamp-Forward Converter

An active-clamp-forward-converter topology alternately drives the MOSFETs. The high-side MOSFET and the capacitor, C_{RESET} , reset the

power transformer in a lossless manner. This topology runs well at duty cycles exceeding 50%. However, the input voltage may not run at 80V.

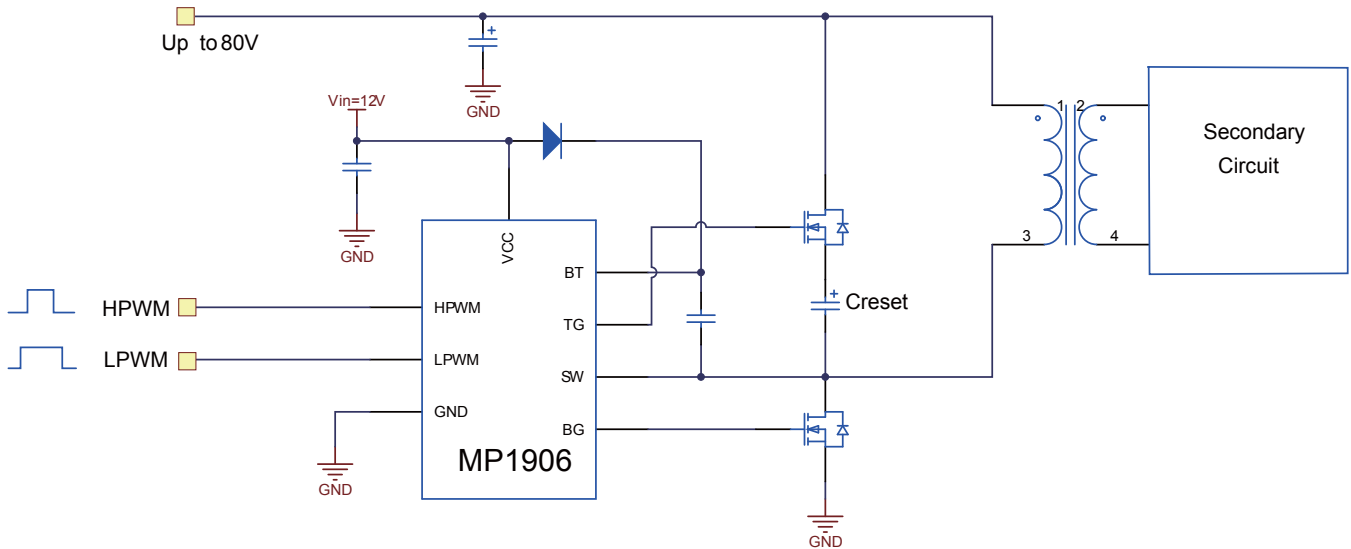
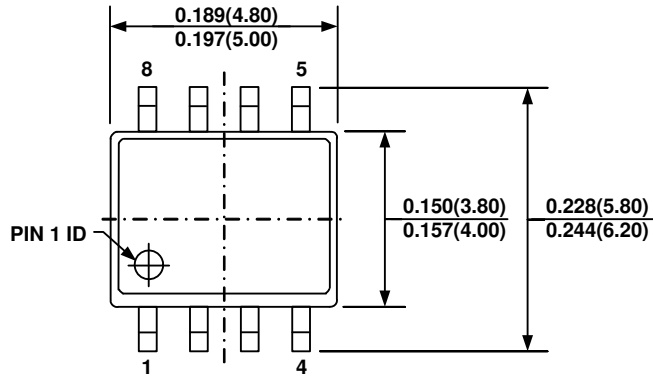

Figure 5: Active-Clamp Forward Converter

PACKAGE INFORMATION

SOIC8



TOP VIEW

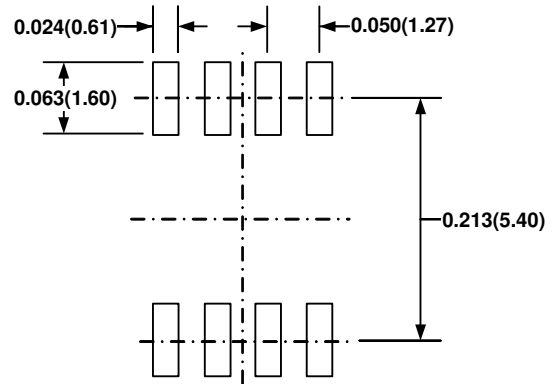

RECOMMENDED LAND PATTERN

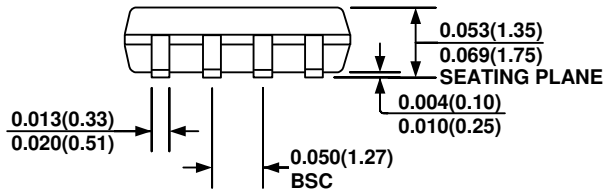

FRONT VIEW

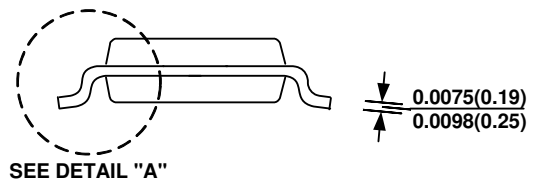

SIDE VIEW

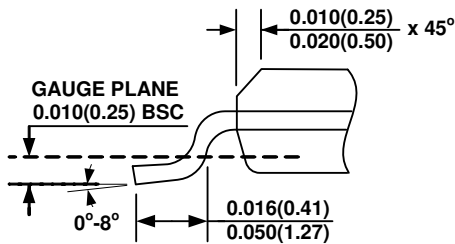

DETAIL "A"

NOTE:

- 1) CONTROL DIMENSION IS IN INCHES. DIMENSION IN BRACKET IS IN MILLIMETERS.
- 2) PACKAGE LENGTH DOES NOT INCLUDE MOLD FLASH, PROTRUSIONS OR GATE BURRS.
- 3) PACKAGE WIDTH DOES NOT INCLUDE INTERLEAD FLASH OR PROTRUSIONS.
- 4) LEAD COPLANARITY (BOTTOM OF LEADS AFTER FORMING) SHALL BE 0.004" INCHES MAX.
- 5) DRAWING CONFORMS TO JEDEC MS-012, VARIATION AA.
- 6) DRAWING IS NOT TO SCALE.

NOTICE: The information in this document is subject to change without notice. Users should warrant and guarantee that third party Intellectual Property rights are not infringed upon when integrating MPS products into any application. MPS will not assume any legal responsibility for any said applications.