



Chipsmall Limited consists of a professional team with an average of over 10 year of expertise in the distribution of electronic components. Based in Hongkong, we have already established firm and mutual-benefit business relationships with customers from,Europe,America and south Asia,supplying obsolete and hard-to-find components to meet their specific needs.

With the principle of “Quality Parts,Customers Priority,Honest Operation,and Considerate Service”,our business mainly focus on the distribution of electronic components. Line cards we deal with include Microchip,ALPS,ROHM,Xilinx,Pulse,ON,Everlight and Freescale. Main products comprise IC,Modules,Potentiometer,IC Socket,Relay,Connector.Our parts cover such applications as commercial,industrial, and automotives areas.

We are looking forward to setting up business relationship with you and hope to provide you with the best service and solution. Let us make a better world for our industry!



Contact us

Tel: +86-755-8981 8866 Fax: +86-755-8427 6832

Email & Skype: info@chipsmall.com Web: www.chipsmall.com

Address: A1208, Overseas Decoration Building, #122 Zhenhua RD., Futian, Shenzhen, China



4-Channel Power Amplifier

FEATURES

- 4 Channel Power Amplifier for Ricoh GEN4/GEN5 Print Heads
- Operate from Single High Current Supply
- 7.5A Pulsed Current ($C=320\text{nF}$, $R=0.1\ \Omega$ @ 15 V/ μsec)
- 1.5A Continuous Current
- Programmable Current Limit

APPLICATIONS

- Ricoh GEN4 and GEN5 Print Heads

DESCRIPTION

The MP204 is a high output current quad channel amplifier for driving the Ricoh GEN4 and GEN5 print heads. The MP204 utilizes ICs combined with discrete semiconductors and passive elements on a thermally conductive insulated metal substrate, delivering very high power from a compact module. The amplifier gain is fixed at 14V/V. Internal compensation provides optimum slew rate and insures stability. The only external components required are the current limit resistors R_{LIM} , a series isolation resistor R_S and power supply bypass capacitors.

Figure 1: Equivalent Schematic (Channel A)

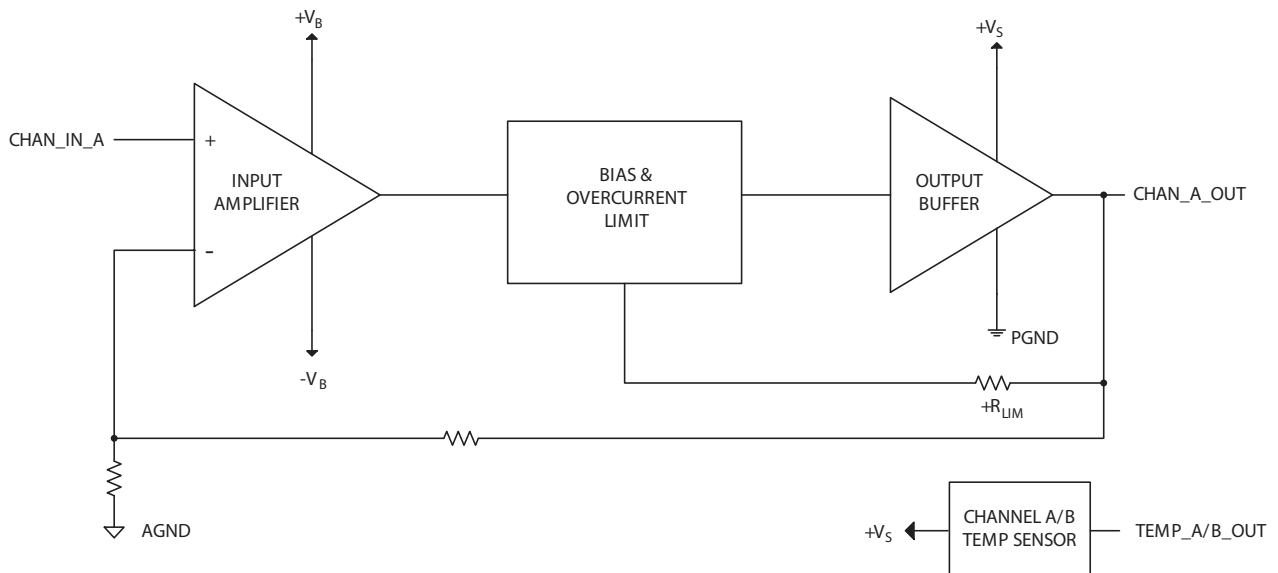

PINOUT AND DESCRIPTION TABLE

Figure 2: External Connections

			PGND_D	42
			PGND_D	41
1	PGND_C		IL_D	40
2	PGND_C		IL_D	39
3	IL_C		+VS_D	38
4	IL_C		+VS_D	37
5	+VS_C		+VB_CD	36
6	+VS_C		TEMP_CD	35
7	OUT_C		TEMP_AB	34
8	SGND_CD		-VB_CD	33
9	IN_D		OUT_D	32
10	IN_C		N/C	31
11	IN_A		+VB_AB	30
12	IN_B		N/C	29
13	SGND_AB		OUT_A	28
14	OUT_B		-VB_AB	27
15	PGND_B		PGND_A	26
16	PGND_B		PGND_A	25
17	IL_B		IL_A	24
18	IL_B		IL_A	23
19	+VS_B		+VS_A	22
20	+VS_B		+VS_A	21

MP204
(Viewed from
backplate)

Pin Number	Name	Description
1,2	PGND_C	Power GND: Channel C
3,4	IL_C	High current output pins for channel C. A current limit resistor must be placed between these pins and the output pin 7
5,6	+VS_C	+Supply Voltage: Channel C
7	OUT_C	Output: Channel C
8	SGND_CD	Signal GND: Channels C/D
9	IN_D	Noninverting Input: Channel D
10	IN_C	Noninverting Input: Channel C
11	IN_A	Noninverting Input: Channel A
12	IN_B	Noninverting Input: Channel B
13	SGND_AB	Signal GND: Channels A/B
14	OUT_B	Output: Channel B
15,16	PGND_B	Power GND: Channel B
17,18	IL_B	High current output pins for channel B. A current limit resistor must be placed between these pins and output pin 14
19,20	+VS_B	+Supply Voltage: Channel B
21,22	+VS_A	+Supply Voltage: Channel A
23,24	IL_A	High current output pins for channel A. A current limit resistor must be placed between these pins and the output pin 28
25,26	PGND_A	Power GND: Channel A
27	-VB_AB	-Boost Supply: Channel A/B
28	OUT_A	Output: Channel A
29,31	N/C	Unused
30	+VB_AB	+ Boost Supply: Channel A/B
32	OUT_D	Output: Channel D
33	-VB_CD	-Boost Supply: Channel C/D
34	TEMP_AB	Channel C Temp Output
35	TEMP_CD	Channel D Temp Output
36	+VB_CD	+ Boost Supply: Channel C/D
37,38	+VS_D	+Supply Voltage: Channel D
39, 40	IL_D	High current output pins for channel D. A current limit resistor must be placed between these pins and output pin 32
41, 42	PGND_D	Power GND: Channel D

SPECIFICATIONS

Unless otherwise noted: $T_C = 25^\circ\text{C}$, DC input specifications are \pm value given. Power supply voltage is typical rating.

ABSOLUTE MAXIMUM RATINGS

Parameter	Symbol	Min	Max	Units
Supply Voltage, $+V_S$	$+V_S$ to PGND		34	V
Positive Boost Supply, $+V_B$	$+V_B$ to PGND	$+V_S$	40	V
Negative Boost Supply, $-V_B$	$-V_B$ to PGND	-12	0.0	V
Overall Supply Voltage, $+V_B(-V_B)$			50	V
Output Current, source, sink, peak, within SOA	I_O		7.5	A
Power Dissipation, continuous @ $T_C = 25^\circ\text{C}$	P_D		20	W/per Channel
Input Voltage ¹		-0.05	+5	V
Temperature, pin solder, 10s max			260	$^\circ\text{C}$
Temperature, junction ²	T_J		150	$^\circ\text{C}$
Temperature Range, storage		-55	+125	$^\circ\text{C}$
Operating Temperature Range, case	T_C	-25	+85	$^\circ\text{C}$

1. Guaranteed by design
2. Long term operation at the maximum junction temperature will result in reduced product life. Derate internal power dissipation to achieve high MTTF.

INPUT (EACH CHANNEL)

Parameter	Test Conditions	Min	Typ	Max	Units
Offset Voltage, initial		-5	± 1	5	mV
Offset Voltage vs. Temperature	Full temp range		± 7		$\mu\text{V}/^\circ\text{C}$
Bias Current, initial		-100	± 20		pA
Input Impedance, DC			10^{13}		Ω
Input Capacitance			6		pF
Input Voltage Range ¹			-0.5 to 2.4		V
Input Noise	f= 1 kHz		14		nV/ $\sqrt{\text{Hz}}$

1. "Min/Max" limited by the common mode range of input amplifier. Typical is that of the input waveform from a DAC to achieve $V_{OUT}=24\text{V}$. Guaranteed by design

GAIN (EACH CHANNEL)

Parameter	Test Conditions	Min	Typ	Max	Units
Fixed Gain			14		V/V
Gain Bandwidth Product -3db			7.4		MHz
Power Bandwidth	+V _S =24V, +V _B = +V _S + 6V, -V _B = -5V, V _{out(lo)} = 2V, V _{out(hi)} =22V		370		kHz
Open Loop Gain @ 15 Hz			96		dB

OUTPUT (EACH CHANNEL)

Parameter	Test Conditions	Min	Typ	Max	Units
Voltage Swing	I _O = 1 A, +V _B = V _S	+V _S -8		+V _S -6	V
Voltage Swing	I _O = -1 A, -V _B = PGND- 5V	PGND+0.4		PGND+1.2	V
Voltage Swing	I _O = 1.5 A, +V _B = V _S + 6V		+V _S -1		V
Current, Peak				7.5	A
Current, Continuous		1.5			A
Slew Rate	Load C _L = 320nF, A _v = 14V/V, R _{LIM} = 0	15			V/μs

POWER SUPPLY

Parameter	Test Conditions	Min	Typ	Max	Units
Positive Supply Voltage, +V _S		3	24	34	V
Positive Boost Voltage, +V _B		8		40	V
Negative Boost Voltage, -V _B		-12		-5	V
+V _S quiescent current	No Load		3.4		mA
+V _B quiescent current	No Load		26		mA
-V _B quiescent current	No Load		26		mA

THERMAL

Parameter	Test Conditions	Min	Typ	Max	Units
Resistance, AC, junction to case ¹	Full temp range, F > 60 Hz		4.5		°C/W
Resistance, DC, junction to case	Full temp range, F < 60 Hz		5.8		°C/W
Resistance, junction to air	Full temp range		14.5		°C/W
Temperature Range, case	Meets full range specifications	-25		+85	°C

1. Rating applies if the output current alternates between both output transistors at a rate faster than 60 Hz.

TEMPERATURE SENSOR

Parameter	Test Conditions	MP204			Units
		Min	Typ	Max	
Temp Sensor Output	T _C = 25°C		2.98		V
Temp Sensor Gain			10		mV/°C
Temperature Accuracy	T _C = -40°C to + 85°C			± 1	°C

TYPICAL PERFORMANCE GRAPHS

Figure 3: Closed Loop Gain vs. Frequency

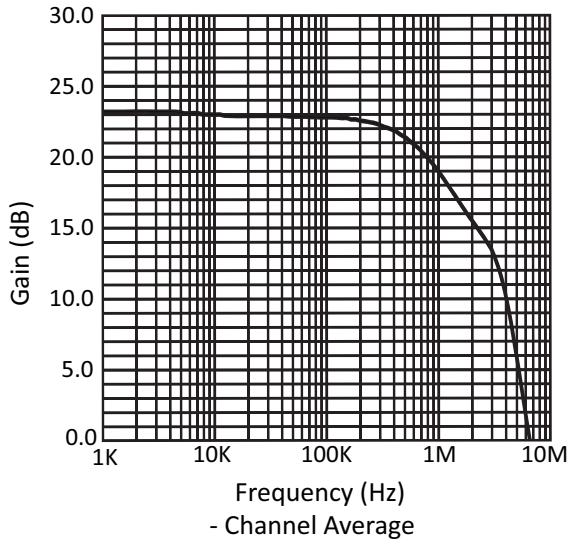

Figure 4: Closed Loop Phase vs. Frequency

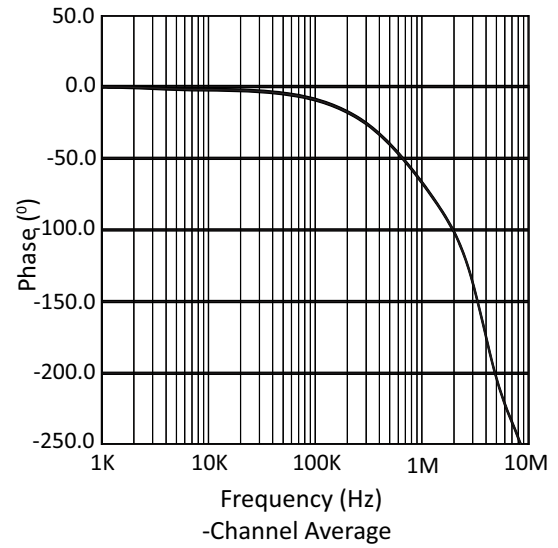

Figure 5: +V_B Quiescent Current vs. Supply Voltage

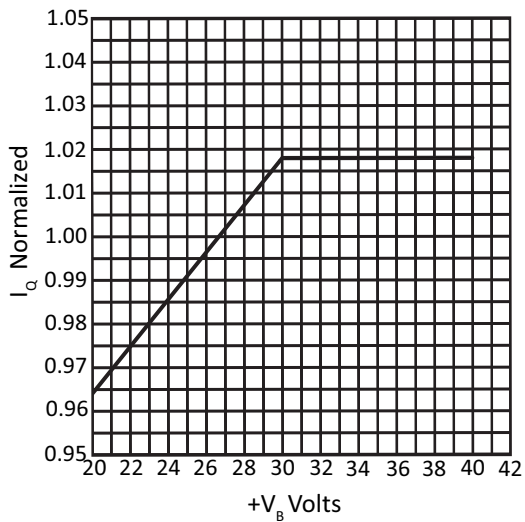

Figure 6: -V_B Quiescent Current vs. Supply Voltage

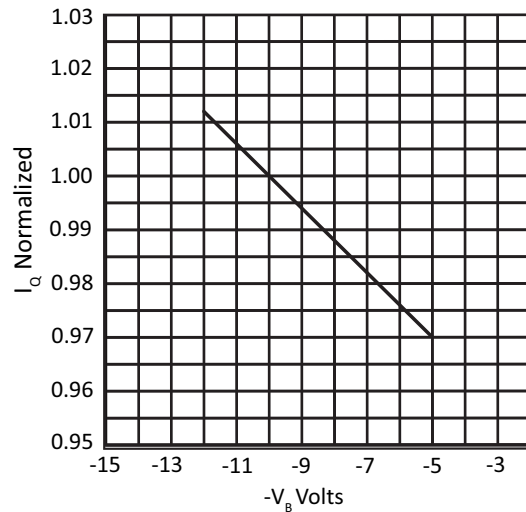

Figure 7: $+V_B$ Quiescent Current vs. Temperature

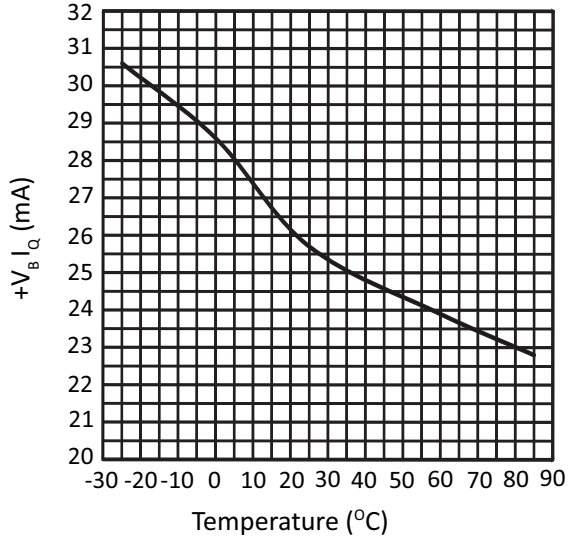

Figure 8: $-V_B$ Quiescent Current vs. Temperature

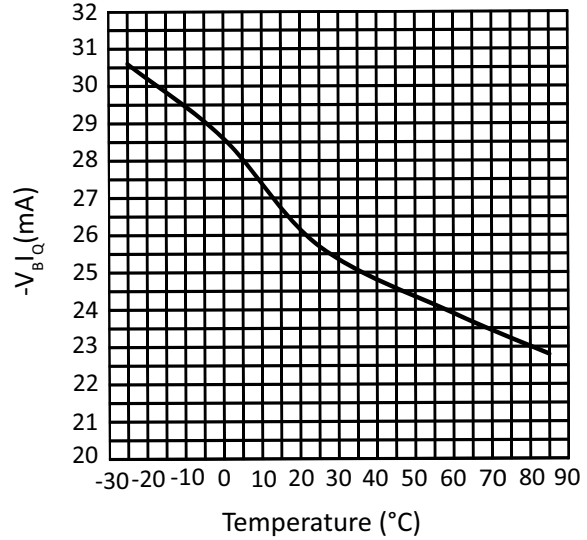

Figure 9: Typical Source Voltage Drop
 $+V_B = +V_S + 6V$

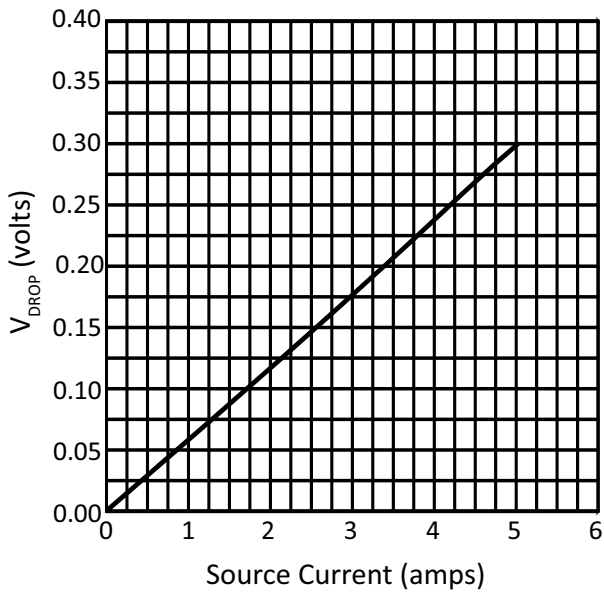

Figure 10: Typical Sink Voltage Drop
 $-V_B = -5V$

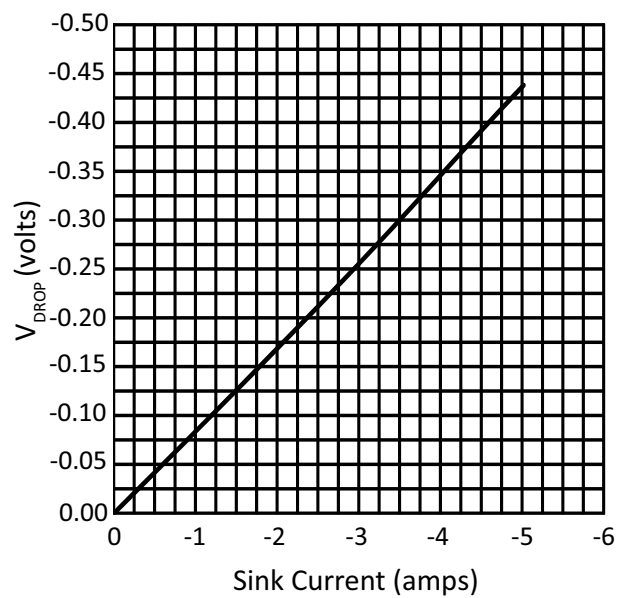

Figure 11: Typical Source Voltage Drop
 $+V_B = +V_S$

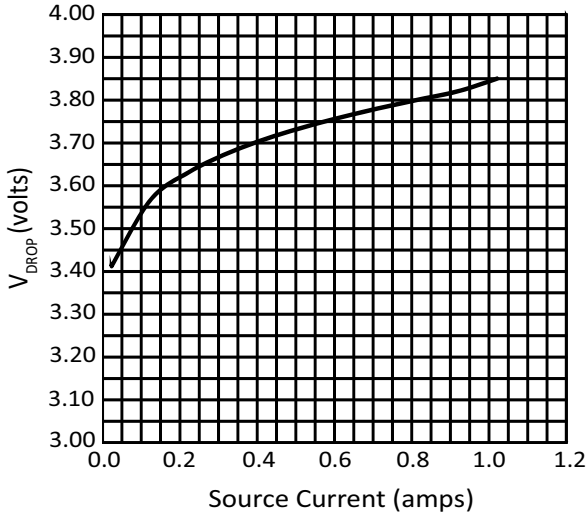

Figure 12: Temperature Monitor Output Voltages (typ.)

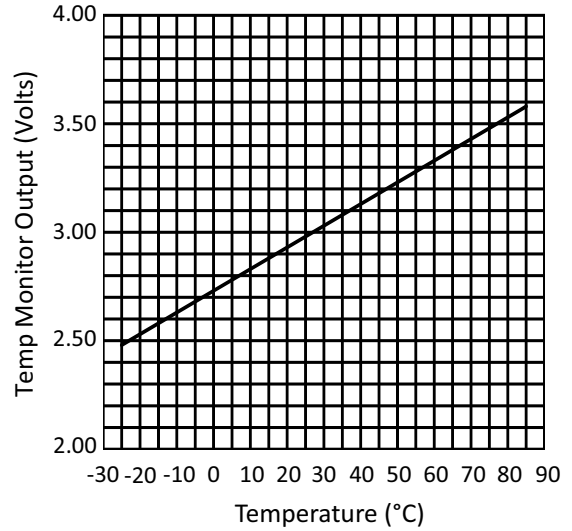

Figure 13: Channel to Channel Gain Variation Five (5) Units

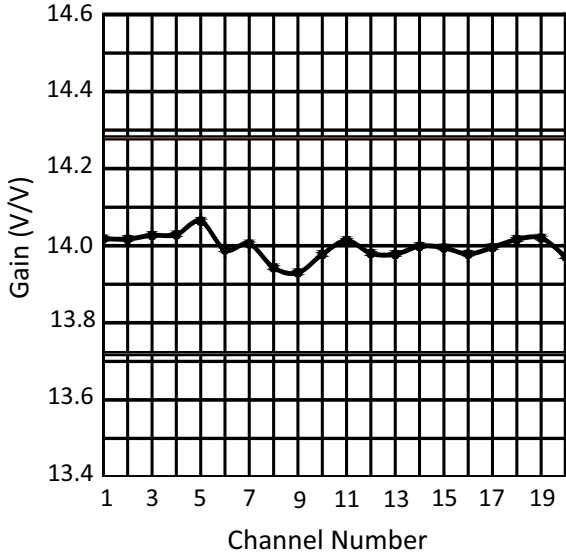

Figure 14: Single Pulse Output Voltage
 $C_{LOAD} = 320nF$

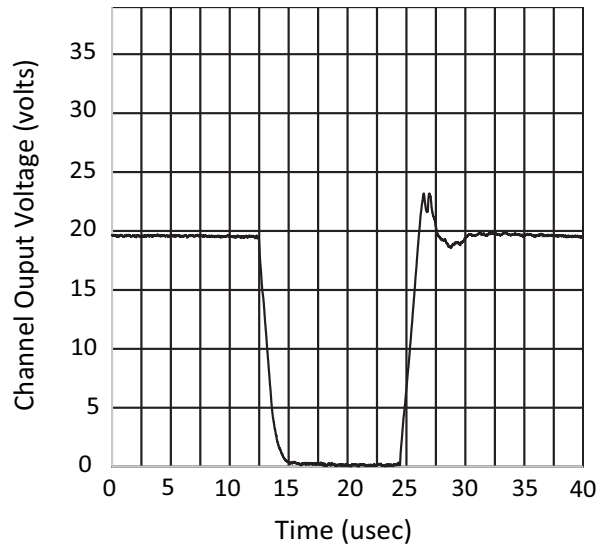

Figure 15: Single Pulse Output Current
 $C_{LOAD} = 320nF$

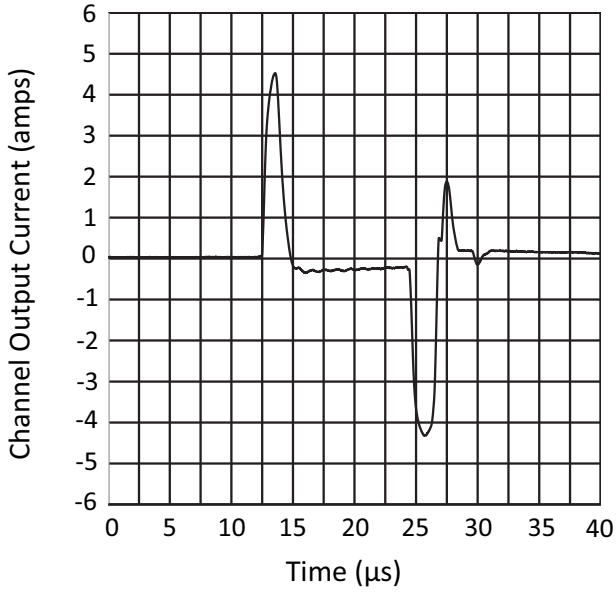

Figure 16: Multi Waveform Voltage
Pattern, $C_{LOAD} = 320nF$

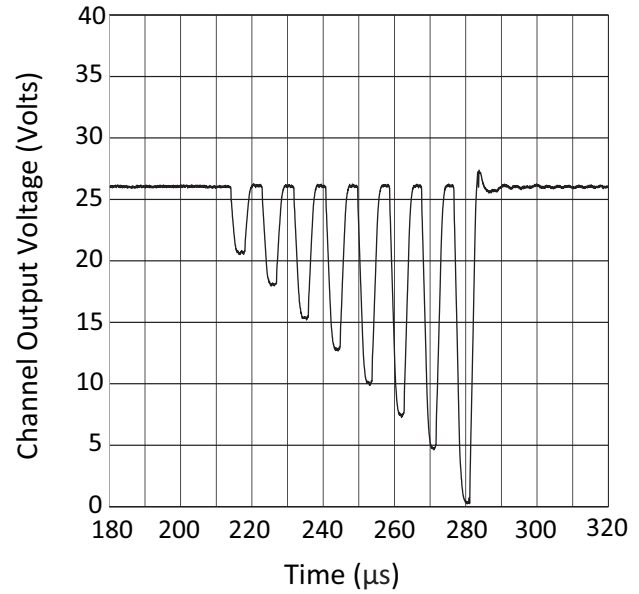
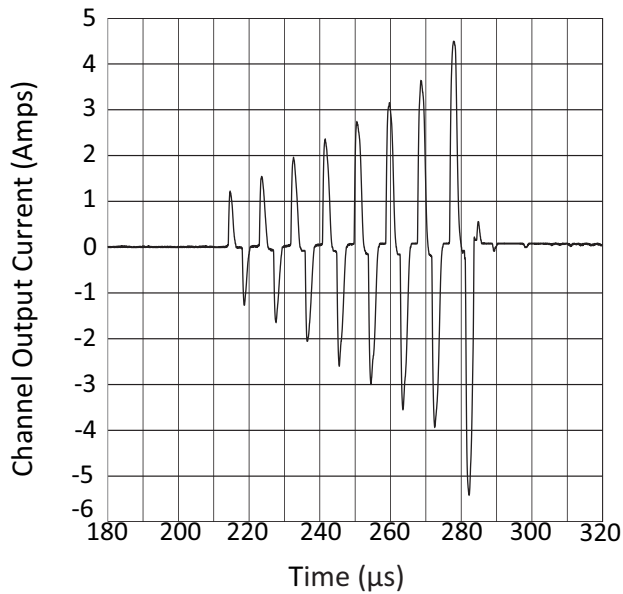
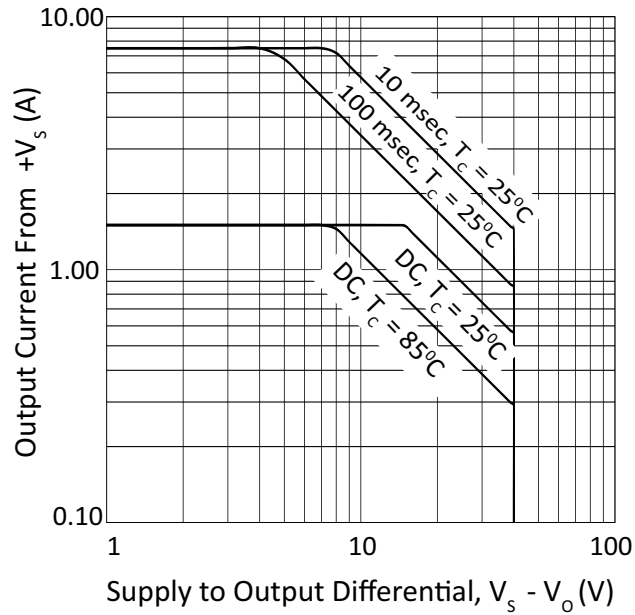

Figure 17: Multi Waveform Current
Patterns, $C_{LOAD} = 320nF$



SAFE OPERATING AREA (SOA)

Figure 18: SOA



POWER DERATING CURVE

Figure 19: Power Derating

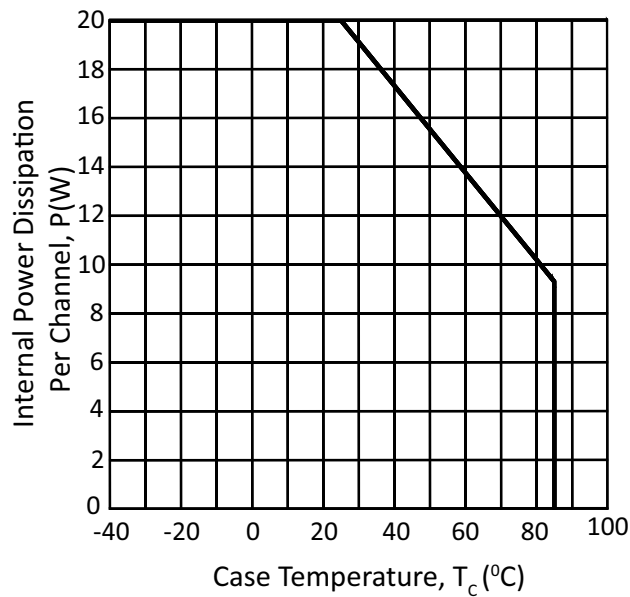

GENERAL

Please read Application Note 1 “General Operating Considerations” which covers stability, supplies, heat sinking, mounting, current limit, SOA interpretation, and specification interpretation. Visit www.apexanalog.com for Apex Microtechnology’s complete Application Notes library, Technical Seminar Workbook, and Evaluation Kits.

TYPICAL APPLICATION

The MP204 consists of four (4) identical channels specifically designed to drive the high capacitance loads of industrial print heads. Each channel has a fixed gain of 14 V/V (22.9 dB) and is internally compensated to operate with capacitive print head loading.

Figure 20: Typical Application (Single Channel)

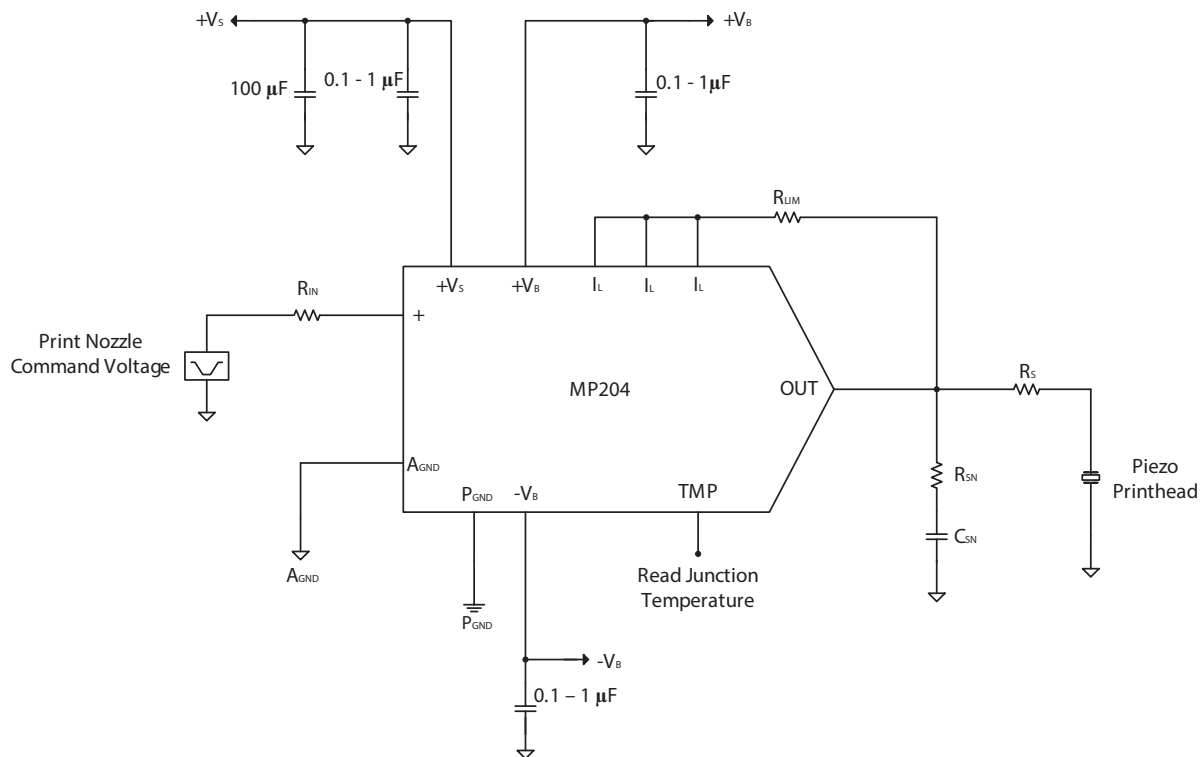

POWER SUPPLY BYPASSING

Bypass capacitors to power supply terminals $+V_S$, $+V_B$ and $-V_B$ must be connected physically close to the pins to prevent local parasitic oscillation in the output stage of the MP204. For $+V_S$ use electrolytic capacitors with at least $10\mu\text{F}$ per amp out of output current capacity. In turn, bypass the electrolytic capacitors for $+V_S$ with high quality ceramic capacitors (X7R) of $0.1\ \mu\text{F}$ or greater. Duplicate the supply bypass elements for the supply terminals of each amplifier channel.

SERIES ISOLATION RESISTOR, R_S

To ensure stability with all capacitive loads, a series isolation resistor should be included between the output and the load as seen in the typical applications schematic. A 1.5 Ω resistor works well for capacitive loads of up to 320 nF. The resistor will affect the rise and fall times of the output pulse at the load; however, this can be compensated by the input signal.

BACKPLATE GROUNDING

The substrate of the MP204 is an insulated metal substrate. It is required that the substrate be properly connected to signal ground but should not be used to carry significant ground current.

TEMPERATURE SENSING

The MP204 has two IC temperature sensors, located near the output MOSFETS of each channel pair (TEMP_AB and TEMP_CD). The scale factor of the sensors is 10 mV/ $^{\circ}$ C. The output voltage of each sensor is equal to approximately 2.98 volts at room temperature ($T_C = 25^{\circ}$ C). The sensors have an uncalibrated temperature error of $\pm 1^{\circ}$ C. The scale factor of each sensor can be adjusted by connecting an optional resistor "R" (refer to Fig. 22) to TEMP_AB and TEMP_CD respectively. The scaled output voltage can be determined by the following equation, where T is the case temperature in $^{\circ}$ C.

$$V_r = \frac{R}{10000 + R}(0.01T + 2.73)$$

R-C SNUBBER CIRCUITS

Driving piezoelectric element provides another design challenge since the load is primarily capacitive. This being said, any inductance in the output connection to the actual printing element can cause output instabilities due to the L-C combination.

Usually the frequency of oscillation is greater than the unity gain bandwidth of the amplifier. To compensate for this shift, it is necessary to lower the high frequency gain of the amplifier. This is accomplished by the addition of the R-C snubber circuit to the amplifier output. The individual component values are dependent on the application requirements. This is accomplished by the addition of the RC snubber circuit to the amplifier output (Figure 21).

Figure 21: RC Snubber Application

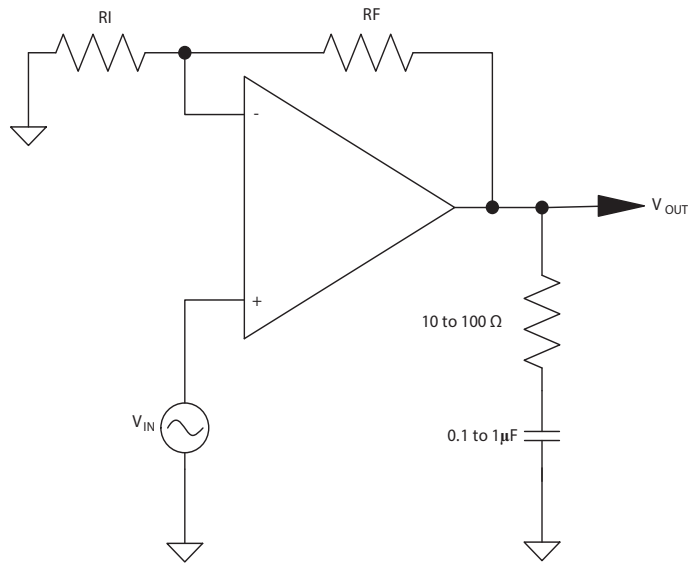
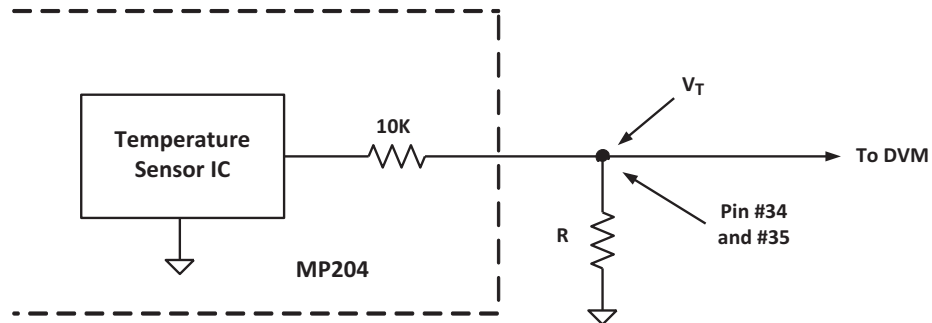

Figure 22: Temperature Sense



CURRENT LIMIT

For proper operation, the current limit resistor (R_{LIM}) must be connected as shown in the *Typical Application* connection diagram. For optimum reliability the resistor value should be set as high as possible. The value is calculated as follows, with the maximum practical value of 30 Ω .

$$R_{LIM} = 0.65V/I_{LIM}$$

INTERNAL POWER DISSIPATION CONSIDERATIONS

The determination of dissipated power in a Drop on Drop print head application is fundamentally difficult, since it is very dependent on the character “content” being printed. This content is also a function of the specific print head algorithm being used.

For the sake of this discussion we will assume that all channels are on simultaneously and are operated at the same frequency.

Total power dissipation in the MP204 amplifiers consists two components;

1. Quiescent Power and
2. Output Stage Power

Quiescent power dissipation is caused by the quiescent current draw of the power op amp. This current is used internally to bias the various stages of the amplifier. It also flows when the amplifier is idling. The quiescent power dissipation can be calculated as:

$$P_{QS} = I_{QS} \times V_S$$

$$P_{QB} = I_{QBS} \times (+V_B - (-V_B))$$

$$P_{Q,TOTAL} = P_{QS} + P_{QB}$$

with I_{QS} and I_{QB} being the quiescent current for V_S and V_B respectively for all the 4 separate amplifiers.

Output (stage) power dissipation is caused by the conducting output stage transistor, dropping a certain voltage from the supply rail to produce the required output voltage, and the output current that flows through this transistor.

Output current can be determined by, where C is the piezo print element capacitance:

$$I_O = C \cdot \frac{dV}{dt} [A]$$

We can determine the average output stage current on the rising and falling edge of the output pulse be:

$$P_{OUT,R} = (V_S - V_{MID}) \times I_O$$

$$P_{OUT,F} = (V_{MID} - V_S) \times I_O$$

This can be written as:

$$P_{D,SWITCHING} = (T_F \times P_{OUT,F} + T_R \times P_{OUT,R}) \times freq$$

Where

T_F = the duration of the falling edge

T_R = the duration of the rising edge

freq = operating frequency

Also note that the total power being dissipated in each the MP204 channels is the sum of the switching losses and quiescent losses

$$P_{DISS_TOTAL} = P_{D,SWITCHING} + P_{Q_1_CH}$$

Where

$$P_{Q_1_CH} = P_{Q_TOTAL}/4$$

This is the per channel power dissipation that needs to be managed for all application scenarios. For further detailed information consult the MP204 Applications Note.

PACKAGE OPTIONS

Part Number	Apex Package Style	Description
MP204	KK	42-Pin Open Frame

PACKAGE STYLE KK

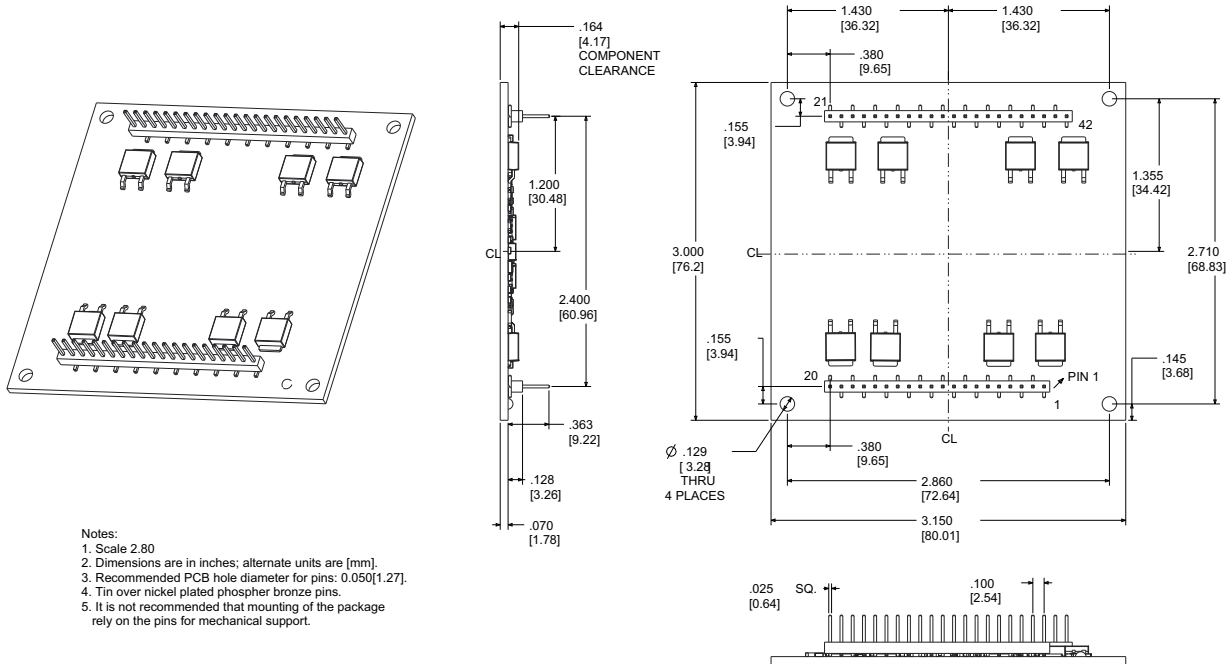

NEED TECHNICAL HELP? CONTACT APEX SUPPORT!

For all Apex Microtechnology product questions and inquiries, call toll free 800-546-2739 in North America. For inquiries via email, please contact apex.support@apexanalog.com. International customers can also request support by contacting their local Apex Microtechnology Sales Representative. To find the one nearest to you, go to www.apexanalog.com

IMPORTANT NOTICE

Apex Microtechnology, Inc. has made every effort to insure the accuracy of the content contained in this document. However, the information is subject to change without notice and is provided "AS IS" without warranty of any kind (expressed or implied). Apex Microtechnology reserves the right to make changes without further notice to any specifications or products mentioned herein to improve reliability. This document is the property of Apex Microtechnology and by furnishing this information, Apex Microtechnology grants no license, expressed or implied under any patents, mask work rights, copyrights, trademarks, trade secrets or other intellectual property rights. Apex Microtechnology owns the copyrights associated with the information contained herein and gives consent for copies to be made of the information only for use within your organization with respect to Apex Microtechnology integrated circuits or other products of Apex Microtechnology. This consent does not extend to other copying such as copying for general distribution, advertising or promotional purposes, or for creating any work for resale.

APEX MICROTECHNOLOGY PRODUCTS ARE NOT DESIGNED, AUTHORIZED OR WARRANTED TO BE SUITABLE FOR USE IN PRODUCTS USED FOR LIFE SUPPORT, AUTOMOTIVE SAFETY, SECURITY DEVICES, OR OTHER CRITICAL APPLICATIONS. PRODUCTS IN SUCH APPLICATIONS ARE UNDERSTOOD TO BE FULLY AT THE CUSTOMER OR THE CUSTOMER'S RISK.

Apex Microtechnology, Apex and Apex Precision Power are trademarks of Apex Microtechnology, Inc. All other corporate names noted herein may be trademarks of their respective holders.