



Chipsmall Limited consists of a professional team with an average of over 10 year of expertise in the distribution of electronic components. Based in Hongkong, we have already established firm and mutual-benefit business relationships with customers from,Europe,America and south Asia,supplying obsolete and hard-to-find components to meet their specific needs.

With the principle of “Quality Parts,Customers Priority,Honest Operation,and Considerate Service”,our business mainly focus on the distribution of electronic components. Line cards we deal with include Microchip,ALPS,ROHM,Xilinx,Pulse,ON,Everlight and Freescale. Main products comprise IC,Modules,Potentiometer,IC Socket,Relay,Connector.Our parts cover such applications as commercial,industrial, and automotives areas.

We are looking forward to setting up business relationship with you and hope to provide you with the best service and solution. Let us make a better world for our industry!



## Contact us

Tel: +86-755-8981 8866 Fax: +86-755-8427 6832

Email & Skype: info@chipsmall.com Web: www.chipsmall.com

Address: A1208, Overseas Decoration Building, #122 Zhenhua RD., Futian, Shenzhen, China



## DESCRIPTION

The MP2499M is a synchronous, rectified, step-down, switch-mode converter with built-in power MOSFETs. The MP2499M offers a very compact solution that achieves a maximum of 3A of continuous output current with built-in, output, line drop compensation.

The MP2499M has synchronous mode operation for high efficiency over the output current load range. Current-mode operation provides fast transient response and eases loop stabilization.

Full protection features include over-current protection (OCP) and thermal shutdown.

The MP2499M requires a minimal number of readily available, standard, external components and is available in a space-saving QFN-13 (2.5mmx3mm) package.

## FEATURES

- Wide 5V to 36V Continuous Operating Input Range
- 85mΩ/55mΩ Low  $R_{DS(ON)}$  Internal Power MOSFETs
- High-Efficiency Synchronous Mode Operation
- Default 270kHz Switching Frequency
- Synchronizes to a 200kHz to 2.4MHz External Clock
- Internal Soft Start
- Output Line Drop Compensation
- Accurate Continuous Output Current Limit with External Resistor
- Over-Current Protection (OCP) and Hiccup
- Thermal Shutdown
- Output Adjustable from 0.8V
- Available in a QFN-13 (2.5mmx3mm) Package

## APPLICATIONS

- USB Dedicated Charging Ports (DCP)
- Automotive Cigarette Lighter Adapters
- USB Chargers
- USB PD Applications

All MPS parts are lead-free, halogen-free, and adhere to the RoHS directive. For MPS green status, please visit MPS website under Quality Assurance. "MPS" and "The Future of Analog IC Technology" are registered trademarks of Monolithic Power Systems, Inc.

## TYPICAL APPLICATION

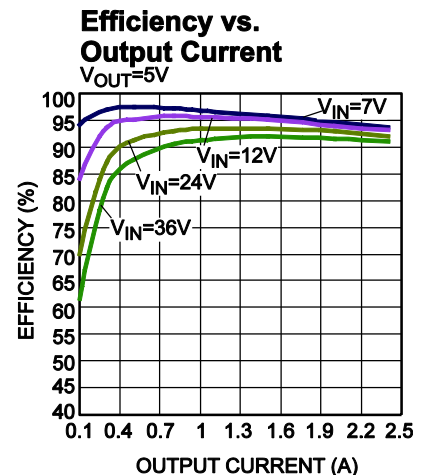
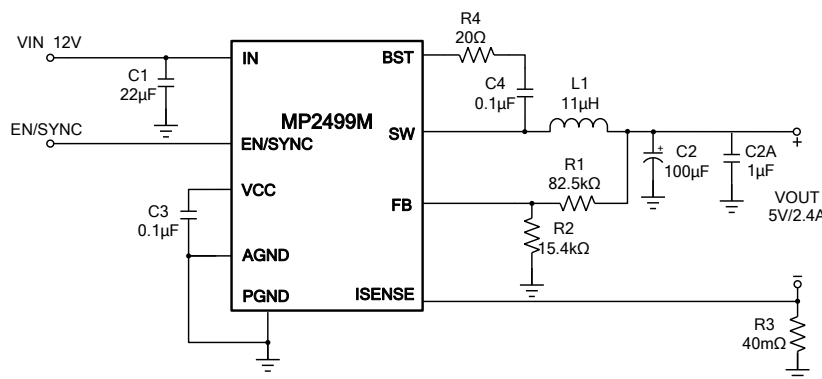

### ORDERING INFORMATION

Part Number*	Package	Top Marking
MP2499MGQB	QFN-13 (2.5mmx3mm)	See Below

\* For Tape & Reel, add suffix -Z (e.g. MP2499MGQB-Z)

### TOP MARKING

**ART**

**YWW**

**LLL**

ART: Product code of MP2499MGQB  
 Y: Year code  
 WW: Week code  
 LLL: Lot number

### PACKAGE REFERENCE

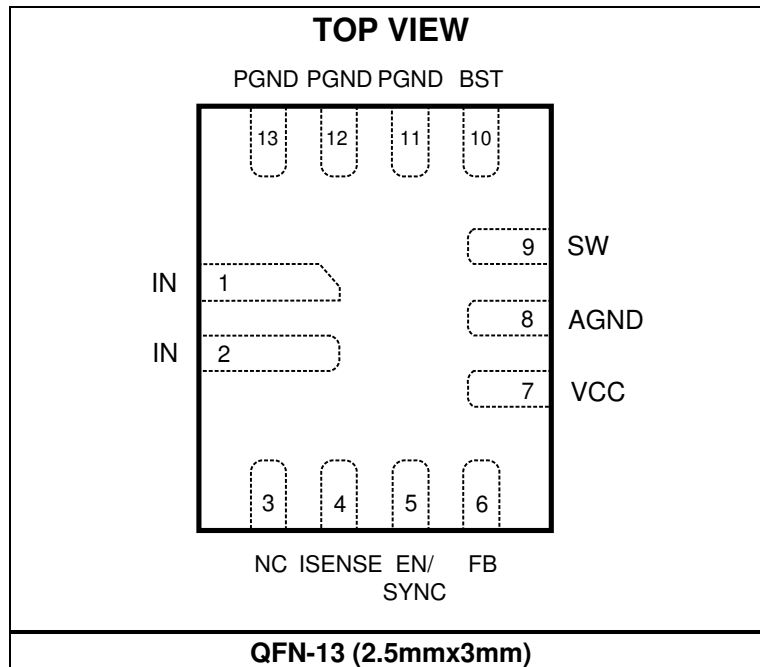

**ABSOLUTE MAXIMUM RATINGS** <sup>(1)</sup>

$V_{IN}$ .....	-0.3V to 40V
$V_{SW}$ .....	-0.3V (-5V for <10ns) to 41V (43V for <10ns)
$V_{BST}$ .....	$V_{SW} + 6V$
All other pins .....	-0.3V to 6V <sup>(2)</sup>
Continuous power dissipation ( $T_A = +25^\circ C$ ) <sup>(3)</sup>	
QFN-13 (2.5mmx3mm) .....	2.08W
Junction temperature .....	150°C
Lead temperature .....	260°C
Storage temperature .....	-65°C to 150°C

**Recommended Operating Conditions**

Continuous supply voltage ( $V_{IN}$ ) .....	5V to 36V
Output voltage ( $V_{OUT}$ ) .....	0.8V to $D_{MAX} \times V_{IN}$
Operating junction temp. ( $T_J$ ) .....	-40°C to +125°C

<b>Thermal Resistance</b> <sup>(4)</sup>	$\theta_{JA}$	$\theta_{JC}$
QFN-13 (2.5mmx3mm) .....	60 .....	13 ... °C/W

**NOTES:**

- 1) Absolute maximum ratings are rated under room temperature unless otherwise noted. Exceeding these ratings may damage the device.
- 2) For details on EN/SYNC's ABS max rating, please refer to the Enable/SYNC Control section on page 12.
- 3) The maximum allowable power dissipation is a function of the maximum junction temperature  $T_J$  (MAX), the junction-to-ambient thermal resistance  $\theta_{JA}$ , and the ambient temperature  $T_A$ . The maximum allowable continuous power dissipation at any ambient temperature is calculated by  $P_D$  (MAX) =  $(T_J$  (MAX) -  $T_A$ ) /  $\theta_{JA}$ . Exceeding the maximum allowable power dissipation produces an excessive die temperature, causing the regulator to go into thermal shutdown. Internal thermal shutdown circuitry protects the device from permanent damage.
- 4) Measured on JESD51-7, 4-layer PCB.

## ELECTRICAL CHARACTERISTICS

$V_{IN} = 12V$ ,  $T_J = -40^{\circ}C$  to  $+125^{\circ}C$  <sup>(5)</sup>, unless otherwise noted. Typical values are at  $T_J = +25^{\circ}C$ .

Parameter	Symbol	Condition	Min	Typ	Max	Units
Supply current (shutdown)	$I_{SHDN}$	$V_{EN} = 0V$			10	$\mu A$
Supply current (quiescent)	$I_Q$	$V_{EN} = 2V$ , $V_{FB} = 1V$		0.7	0.9	mA
HS switch on resistance	$R_{ON\_HS}$	$V_{BST-SW} = 5V$		85	150	m $\Omega$
LS switch on resistance	$R_{ON\_LS}$	$V_{CC} = 5V$		55	105	m $\Omega$
Switch leakage	$I_{LKG\_SW}$	$V_{EN} = 0V$ , $V_{SW} = 12V$			1	$\mu A$
Current limit	$I_{LIMIT}$	Under 40% duty cycle	4	6	8	A
Oscillator frequency	$f_{SW}$	$V_{FB} = 750mV$	200	270	340	kHz
Foldback frequency	$f_{FB}$	$V_{FB} < 240mV$ , and OC ( $V_{COMP}$ is high)		70		kHz
Maximum duty cycle <sup>(6)</sup>	$D_{MAX}$	$V_{FB} = 750mV$ , 250kHz		97		%
Minimum on time <sup>(6)</sup>	$t_{ON\_MIN}$			70		ns
Sync frequency range	$f_{SYNC}$		0.2		2.4	MHz
ISENSE reference voltage	$V_{ISENSE}$		94	118	142	mV
Line drop compensation current	$I_{SINK}$	$I_O = 2.4A$ , $R_{SENSE} = 40m\Omega$ , $T_J = 25^{\circ}C$	4	6	8	$\mu A$
Feedback voltage	$V_{FB}$	$T_J = 25^{\circ}C$	780	792	804	mV
		$T_J = -40^{\circ}C$ to $85^{\circ}C$	776	792	808	
Feedback current	$I_{FB}$	$V_{FB} = 820mV$		10	100	nA
EN/SYNC rising threshold	$V_{EN\_RISING}$		1.15	1.4	1.65	V
EN/SYNC falling threshold	$V_{EN\_FALLING}$		1.05	1.25	1.45	V
EN/SYNC threshold hysteresis	$V_{EN\_HYS}$			150		mV
$V_{IN}$ under-voltage lockout threshold rising	$INUV_{RISING}$		4.2	4.5	4.8	V
$V_{IN}$ under-voltage lockout threshold-falling	$INUV_{FALLING}$		4	4.3	4.6	V
$V_{IN}$ under-voltage lockout threshold hysteresis	$INUV_{HYS}$			200		mV
VCC regulator	$V_{CC}$	$I_{CC} = 0mA$	4.6	4.9	5.2	V
VCC load regulation		$I_{CC} = 5mA$		1.5	4	%
Soft-start period	$t_{SS}$	$V_{OUT}$ from 10% to 90%		1.6		ms
Thermal shutdown <sup>(6)</sup>				170		$^{\circ}C$
Thermal hysteresis <sup>(6)</sup>				30		$^{\circ}C$

### NOTES:

5) Not tested in production. Guaranteed by over-temperature correlation.

6) Guaranteed by design and engineering sample characterization.

## TYPICAL PERFORMANCE CHARACTERISTICS

$V_{IN} = 12V$ ,  $V_{OUT} = 5V$ ,  $L = 11\mu H$ ,  $T_A = +25^\circ C$ , unless otherwise noted.

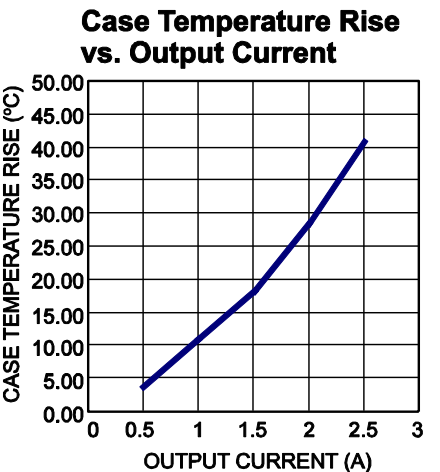
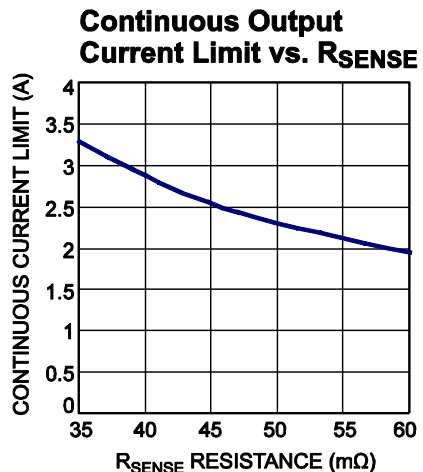
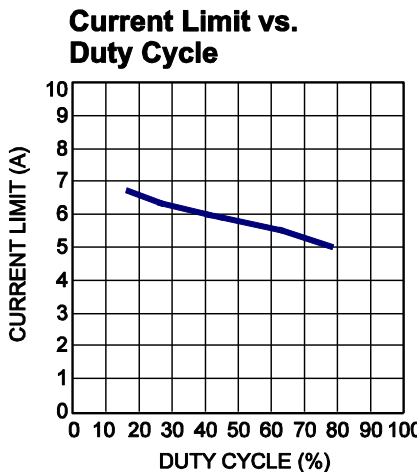
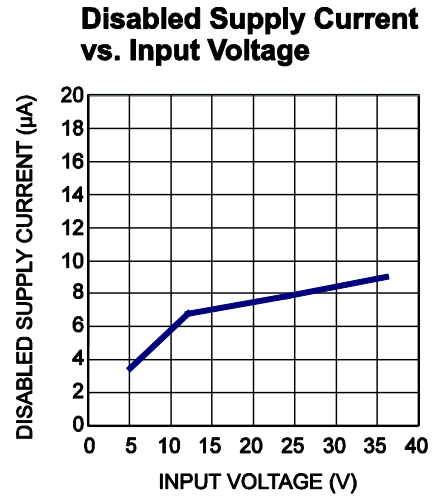
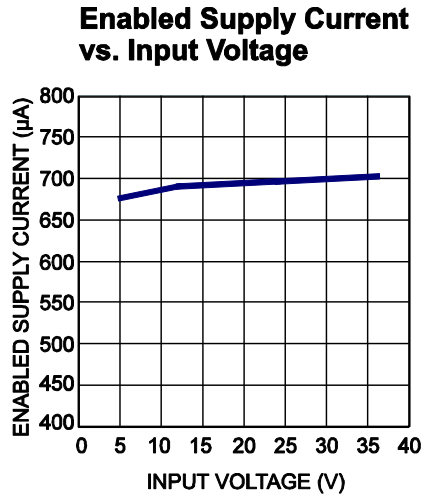
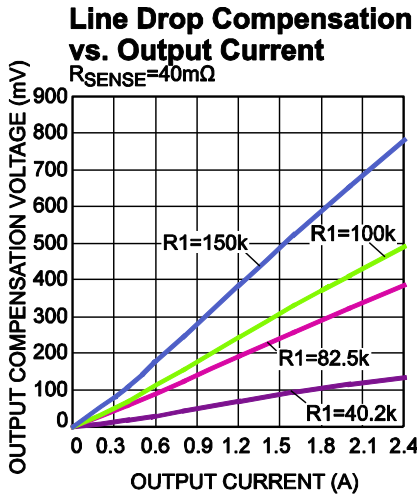
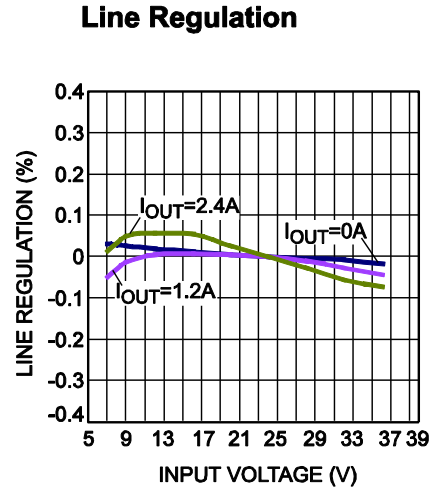
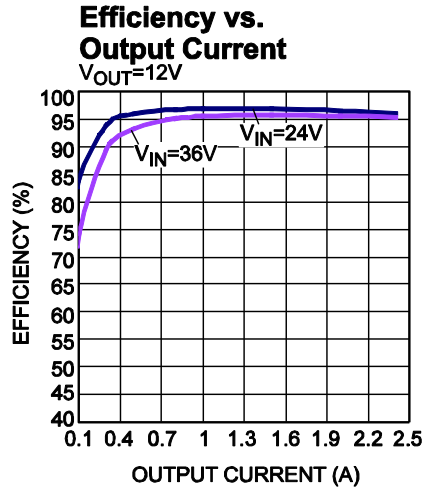
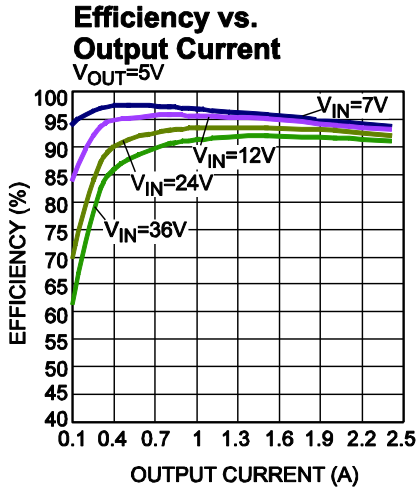

**TYPICAL PERFORMANCE CHARACTERISTICS** *(continued)*
 $V_{IN} = 12V$ ,  $V_{OUT} = 5V$ ,  $L = 11\mu H$ ,  $T_A = +25^\circ C$ , unless otherwise noted.

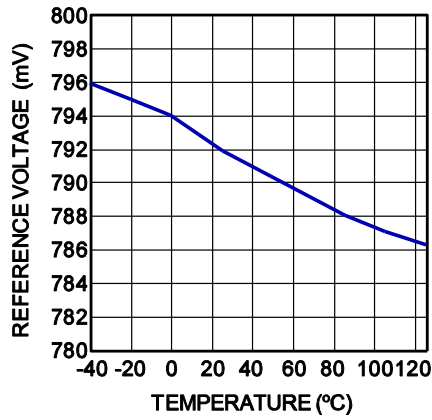
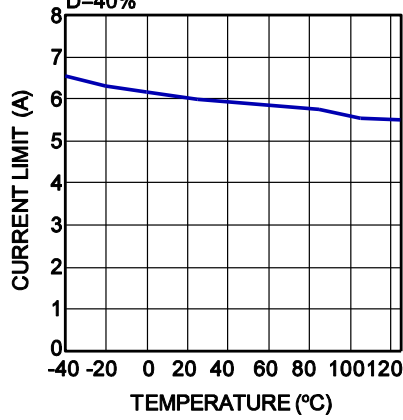
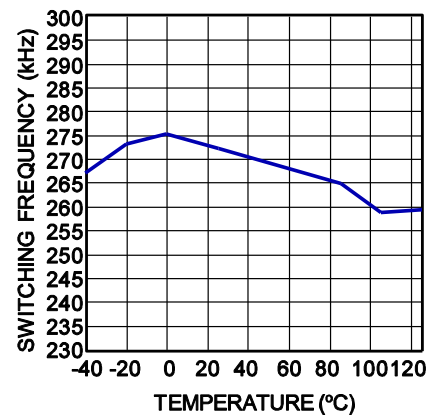
**Reference Voltage vs. Temperature**

**Current Limit vs. Temperature**

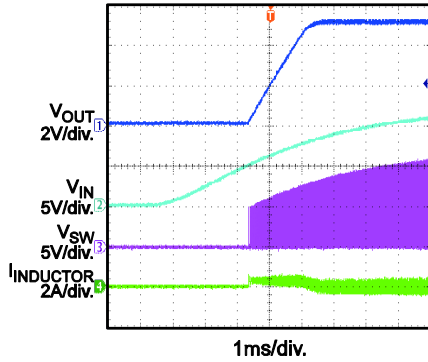
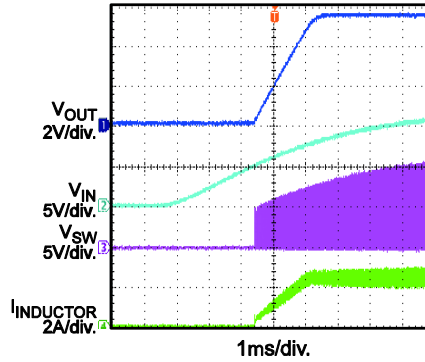
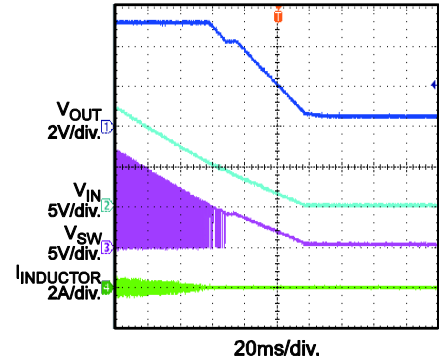
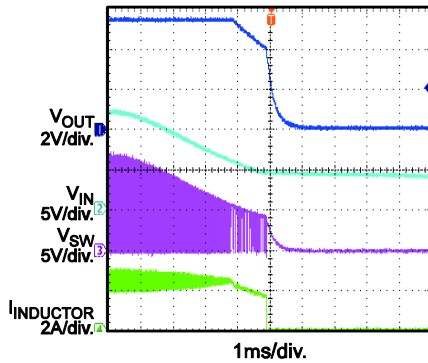
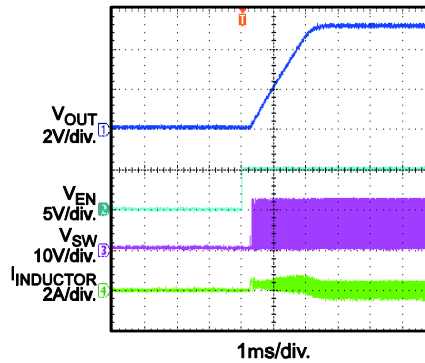
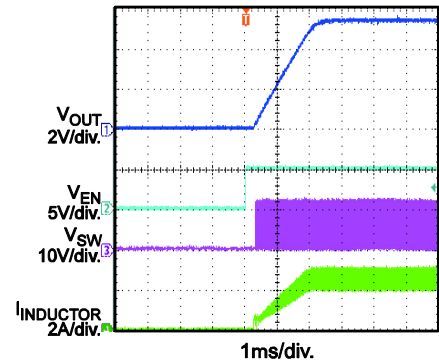
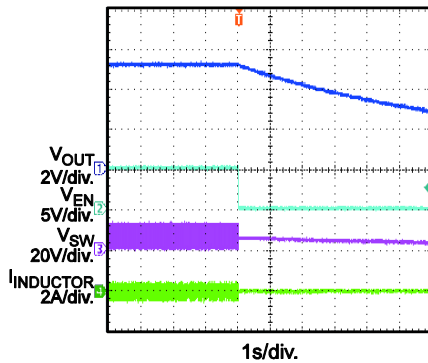
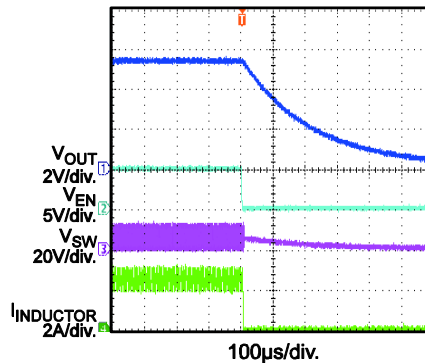
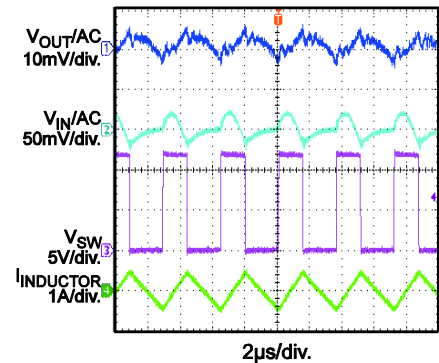
**Switching Frequency vs. Temperature**

**TYPICAL PERFORMANCE CHARACTERISTICS (continued)**
 $V_{IN} = 12V$ ,  $V_{OUT} = 5V$ ,  $L = 11\mu H$ ,  $T_A = +25^\circ C$ , unless otherwise noted.

**Start-Up through  $V_{IN}$** 
 $I_{OUT} = 0A$ 

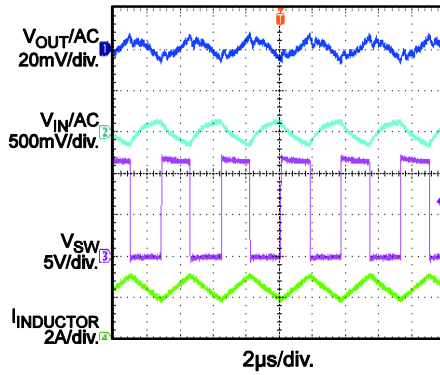
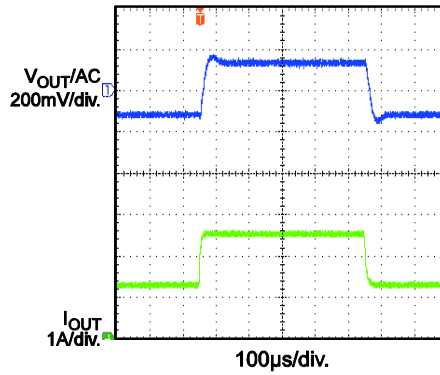
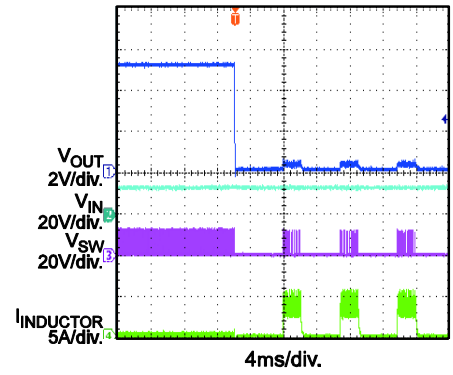
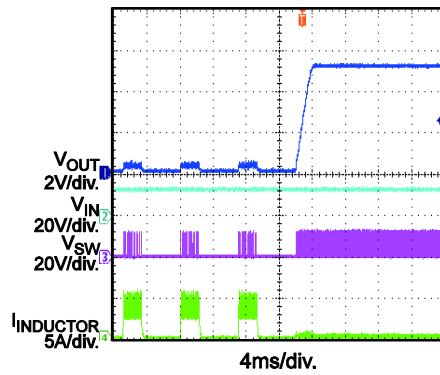
**Start-Up through  $V_{IN}$** 
 $I_{OUT} = 2.4A$ 

**Shutdown through  $V_{IN}$** 
 $I_{OUT} = 0A$ 

**Shutdown through  $V_{IN}$** 
 $I_{OUT} = 2.4A$ 

**Start-Up through EN/SYNC**
 $I_{OUT} = 0A$ 

**Start-Up through EN/SYNC**
 $I_{OUT} = 2.4A$ 

**Shutdown through EN/SYNC**
 $I_{OUT} = 0A$ 

**Shutdown through EN/SYNC**
 $I_{OUT} = 2.4A$ 

**Output Voltage Ripple**
 $I_{OUT} = 0A$ 



**TYPICAL PERFORMANCE CHARACTERISTICS (continued)**
 $V_{IN} = 12V$ ,  $V_{OUT} = 5V$ ,  $L = 11\mu H$ ,  $T_A = +25^\circ C$ , unless otherwise noted.

**Output Voltage Ripple**
 $I_{OUT} = 2.4A$ 

**Load Transient Response**
 $I_{OUT} = 1.2A-2.4A$ 

**Short-Circuit Entry**
 $I_{OUT} = 0A$ 

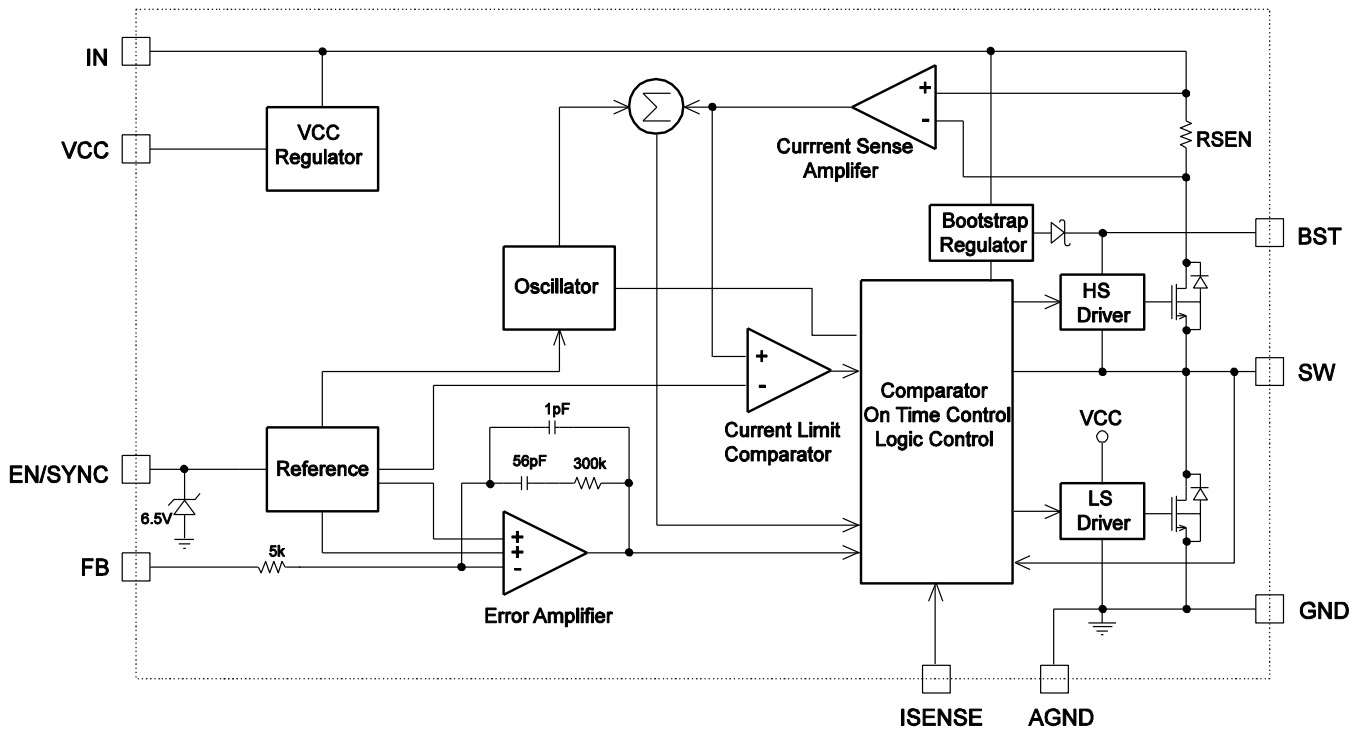
**Short-Circuit Recovery**
 $I_{OUT} = 0A$ 

**PIN FUNCTIONS**

Package Pin #	Name	Description
1, 2	IN	<b>Supply voltage.</b> The MP2499M operates from a 5V to 36V input rail. A capacitor (C1) is required to decouple the input rail. Connect IN using a wide PCB trace.
3	NC	<b>No connection.</b> Do not connect.
4	ISENSE	<b>Output current sense.</b> Connect a resistor from ISENSE close to AGND to sense the output current and set the continuous output current limit threshold.
5	EN/SYNC	<b>Enable/synchronize.</b> Drive EN/SYNC high to enable the MP2499M; drive EN/SYNC low to disable the MP2499M. EN/SYNC cannot be floated. Apply an external clock to EN/SYNC to change the switching frequency.
6	FB	<b>Feedback.</b> Connect FB to the tap of an external resistor divider from the output to GND to set the output voltage. The frequency foldback comparator lowers the oscillator frequency when the FB voltage is below 240mV to prevent current limit runaway during a short-circuit fault condition.
7	VCC	<b>Bias supply.</b> Decouple VCC with a 0.1 $\mu$ F to 0.22 $\mu$ F capacitor. Select a capacitor that does not exceed 0.22 $\mu$ F.
8	AGND	<b>Analog ground.</b>
9	SW	<b>Switch output.</b> Connect SW using a wide PCB trace.
10	BST	<b>Bootstrap.</b> A capacitor is required connected between SW and BST to form a floating supply across the high-side switch driver. A 20 $\Omega$ resistor placed between the SW and BST capacitor is strongly recommended to reduce SW voltage spikes.
11, 12, 13	PGND	<b>System ground.</b> PGND is the reference ground of the regulated output voltage. PGND required requires special care during PCB layout. For best results, connect PGND with copper traces and vias.

**BLOCK DIAGRAM**

**Figure 1: Functional Block Diagram**

## OPERATION

The MP2499M is a high-frequency, synchronous, rectified, step-down, switch-mode converter with built-in power MOSFETs. The MP2499M offers a very compact solution to achieve 3A max of continuous output current with built-in output line drop compensation.

The MP2499M operates in a fixed-frequency, peak-current-control mode to regulate the output voltage. An internal clock initiates a PWM cycle. The integrated high-side power MOSFET (HS-FET) turns on and remains on until its current reaches the value set by the error amplifier (EA) COMP voltage ( $V_{COMP}$ ). When the power switch is off, it remains off until the next clock cycle begins. If the current in the power MOSFET does not reach the current value set by COMP within 97% of one PWM period, the power MOSFET is forced off.

### Internal Regulator

The 5V internal regulator powers most of the internal circuitries. This regulator takes the  $V_{IN}$  input and operates in the full  $V_{IN}$  range. When  $V_{IN}$  exceeds 5.0V, the output of the regulator is in full regulation. When  $V_{IN}$  falls below 5.0V, the output of the regulator decreases following  $V_{IN}$ . A 0.1 $\mu$ F decoupling ceramic capacitor is needed at VCC.

### Error Amplifier (EA)

The error amplifier (EA) compares the FB voltage against the internal 0.8V reference (REF) and outputs a COMP voltage. This COMP voltage controls the power MOSFET current. The optimized internal compensation network minimizes the external component count and simplifies the control loop design.

### Enable/SYNC Control

EN/SYNC is a digital control pin that turns the regulator on and off. Drive EN/SYNC high to turn on the regulator; drive EN/SYNC low to turn off the regulator. EN/SYNC cannot be floated.

EN/SYNC is clamped internally using a 6.5V series Zener diode (see Figure 2). Connect the EN/SYNC input through a pull-up resistor to any voltage connected to IN. The pull-up resistor limits the EN/SYNC input current below 150 $\mu$ A.

For example, with 12V connected to  $V_{IN}$ ,  $R_{PULLUP} \geq (12V - 6.5V) \div 150\mu A = 36.7k\Omega$ .

Connecting EN/SYNC to a voltage source directly without a pull-up resistor requires limiting the voltage amplitude to  $\leq 6V$  to prevent damage to the Zener diode.

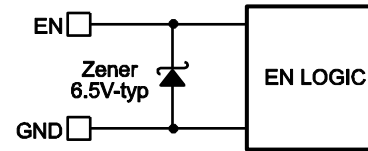

**Figure 2: 6.5V Type Zener Diode**

Connect an external clock with a range of 200kHz to 2.4MHz to synchronize the internal clock rising edge to the external clock rising edge. The pulse width of the external clock signal should be less than 3 $\mu$ s.

### Under-Voltage Lockout (UVLO)

Under-voltage lockout (UVLO) protects the chip from operating at an insufficient supply voltage. The MP2499M UVLO comparator monitors the output voltage of the internal regulator (VCC). The UVLO rising threshold is about 4.5V, while its falling threshold is 4.3V.

### Internal Soft Start (SS)

Soft start (SS) prevents the converter output voltage from overshooting during start-up. When the chip starts up, the internal circuitry generates a soft-start voltage that ramps up from 0V to 1.2V. When SS is lower than REF, SS overrides REF so the error amplifier uses SS as the reference. When SS exceeds REF, the error amplifier uses REF as the reference. The SS time is set to 1.6ms internally.

### Output Line Drop Compensation

The MP2499M is capable of compensating for an output voltage drop, such as high impedance caused by a long trace, to maintain a fairly constant load-side voltage.

The MP2499M uses the sensed load current through the external sensing resistor ( $R_{SENSE}$ ) to sink a current ( $I_{SINK}$ ) at FB. Calculate  $I_{SINK}$  with Equation (1):

$$I_{SINK} = \frac{I_{LOAD} \cdot R_{SENSE}}{16.5k} \quad (1)$$

This current flows through the feedback resistor (R1) and generates the compensation voltage ( $V_{COMP}$ ) (see Figure 3).

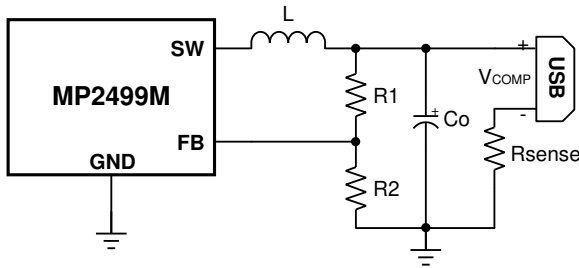
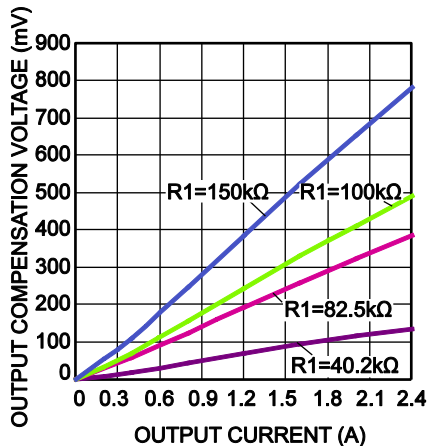

**Figure 3: Output Line Drop Compensation**

Calculate  $V_{COMP}$  with Equation (2):

$$V_{COMP} = I_{LOAD} \cdot R_{SENSE} \left( \frac{R1}{16.5k} - 1 \right) \quad (2)$$

The line drop compensation voltage amplitude increases linearly as the load current increases. Setting a different R1 value can produce different voltages to compensate for the cable drop voltage (see Figure 4). When the load current is 2.4A, R1 is 82.5k $\Omega$ ,  $R_{SENSE}$  is 40m $\Omega$ , and the compensation voltage is 384mV.



**Figure 4: Output Line Drop Compensation at Different R1 Values**

### Over-Current Protection (OCP) and Hiccup

The MP2499M uses a cycle-by-cycle over-current limit when the inductor current peak value exceeds the current limit threshold. If the output voltage drops until FB is below the under-voltage (UV) threshold (typically 30% below the reference), the MP2499M enters hiccup mode to restart the part periodically. This protection mode is especially useful when

the output is dead-shortened to ground. The average short-circuit current is reduced greatly to alleviate thermal issues and protect the regulator. The MP2499M exits hiccup mode once the over-current condition is removed.

The MP2499M also has a continuous output current limit. A current sensing resistor senses the load current to protect the output from over-current. If output over-current is detected (ISENSE voltage exceeds 118mV), and the output voltage drops until FB is 30% below the reference, the MP2499M enters hiccup mode. The MP2499M enters hiccup mode when the soft start finishes, over-current occurs (internal cycle-by-cycle inductor peak current limit or external sensed continuous output current limit), and FB falls below the UV threshold.

### Thermal Shutdown

Thermal shutdown prevents the chip from operating at exceedingly high temperatures. When the silicon die temperature exceeds 170°C, the entire chip shuts down. When the temperature drops below its lower threshold (typically 140°C), the chip is enabled again.

### Floating Driver and Bootstrap Charging

An external bootstrap capacitor powers the floating power MOSFET driver. A dedicated internal regulator charges and regulates the bootstrap capacitor voltage to ~5V (see Figure 5). When the voltage between the BST and SW nodes drops below regulation, a PMOS pass transistor connected from  $V_{IN}$  to BST turns on. The charging current path is from  $V_{IN}$  to BST to SW. The external circuit should provide enough voltage headroom to facilitate charging. As long as  $V_{IN}$  is significantly higher than SW, the bootstrap capacitor remains charged.

When the HS-FET is on,  $V_{IN} \approx V_{SW}$ , so the bootstrap capacitor cannot charge. When the low-side MOSFET (LS-FET) is on,  $V_{IN} - V_{SW}$  reaches its maximum for fast charging. When there is no inductor current,  $V_{SW} = V_{OUT}$ , so the difference between  $V_{IN}$  and  $V_{OUT}$  can charge the bootstrap capacitor. The floating driver has its own UVLO protection with a rising threshold of 2.2V and hysteresis of 150mV. A 20 $\Omega$  resistor placed between the SW and BST capacitor is strongly recommended to reduce SW voltage spikes.

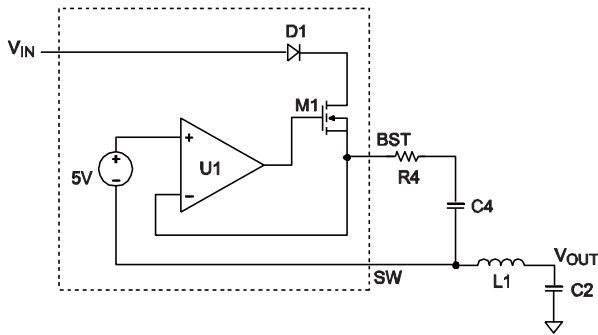

**Figure 5: Internal Bootstrap Charging Circuit**

### Start-Up and Shutdown

If both  $V_{IN}$  and EN/SYNC exceed their thresholds respectively, the chip starts up. The reference block starts first, generating stable reference voltages and currents, and then the internal regulator is enabled. The regulator provides a stable supply for the remaining circuitries.

Three events can shut down the chip: EN/SYNC low,  $V_{IN}$  low, and thermal shutdown. In the shutdown procedure, the signaling path is blocked first to avoid any fault triggering. The EA  $V_{COMP}$  and the internal supply rail are then pulled down. The floating driver is not subject to this shutdown command.

## APPLICATION INFORMATION

### Setting the Output Voltage

The external resistor divider sets the output voltage (see Figure 6). The feedback resistor (R1) sets the feedback loop bandwidth with the internal compensation capacitor. Choose R1 to be around 82.5kΩ. R2 can then be calculated with Equation (2):

$$R2 = \frac{R1}{\frac{V_{OUT}}{0.792V} - 1} \quad (2)$$

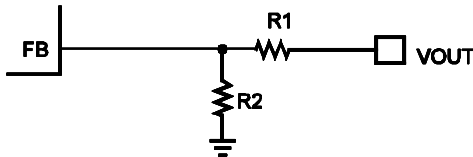

**Figure 6: Feedback Network**

### Selecting the Inductor

For most applications, use a 10μH to 20μH inductor with a DC current rating at least 25% percent higher than the maximum load current. For the highest efficiency, an inductor with a small DC resistance is recommended. For most designs, the inductance value can be derived from Equation (3):

$$L_1 = \frac{V_{OUT} \times (V_{IN} - V_{OUT})}{V_{IN} \times \Delta I_L \times f_{OSC}} \quad (3)$$

Where  $\Delta I_L$  is the inductor ripple current.

Choose the inductor ripple current to be approximately 40% of the maximum load current. The maximum inductor peak current can be calculated with Equation (4):

$$I_{L(MAX)} = I_{LOAD} + \frac{\Delta I_L}{2} \quad (4)$$

### Setting the Continuous Output Current Limit

The MP2499M has a programmable continuous output current limit which is set by an external resistor ( $R_{SENSE}$ ). The current limit can be calculated with Equation (5):

$$I_{CC\_LIMIT} = \frac{V_{ISENSE}}{R_{SENSE}} \quad (5)$$

Where  $V_{ISENSE} = 118mV$ .

Choose a different  $R_{SENSE}$  to set a different continuous output current limit. For  $R_{SENSE} = 40m\Omega$ , the current limit is 2.95A.

### Setting the Line Drop Compensation

The MP2499M is able to generate a compensation voltage ( $V_{COMP}$ ) to compensate for the line drop at the output (see Figure 3).

$V_{COMP}$  can be calculated with Equation (6):

$$V_{COMP} = I_{LOAD} \cdot R_{SENSE} \left( \frac{R1}{16.5k} - 1 \right) \quad (6)$$

When the load current is 2.4A, R1 is 82.5kΩ,  $R_{SENSE}$  is 40mΩ, and  $V_{COMP}$  is 384mV.

### Setting $V_{IN}$ UVLO

The MP2499M has an internal, fixed, under-voltage lockout (UVLO) threshold. The rising threshold is 4.5V while the falling threshold is about 4.3V. For applications requiring a higher UVLO point, an external resistor divider between EN/SYNC and IN can be used to achieve a higher equivalent UVLO threshold (see Figure 7).

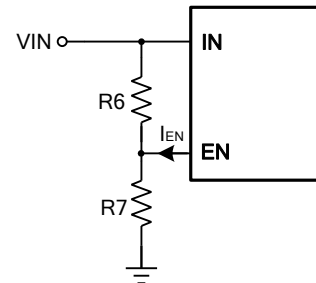

**Figure 7: Adjustable UVLO using EN/SYNC Divider**

The UVLO threshold can be calculated with Equation (7) and Equation (8):

$$INUV_{RISING} = \left( 1 + \frac{R6}{R7} \right) \cdot V_{EN\_RISING} - I_{EN} \cdot R6 \quad (7)$$

$$INUV_{FALLING} = \left( 1 + \frac{R6}{R7} \right) \cdot V_{EN\_FALLING} - I_{EN} \cdot R6 \quad (8)$$

Where  $V_{EN\_RISING} = 1.4V$ ,  $V_{EN\_FALLING} = 1.25V$ , and  $I_{EN} = 7\mu A$ .

When choosing R6, ensure that it is large enough to limit the current flow into EN/SYNC below 150μA.

### Selecting the Input Capacitor

The input current to the step-down converter is discontinuous and therefore requires a capacitor to supply AC current to the step-down converter while maintaining the DC input voltage. Use low ESR capacitors for the best performance. Ceramic capacitors with X5R or X7R dielectrics are recommended for best results because of their low ESR and small temperature coefficients. For CLA applications, a 100µF electrolytic capacitor and two 10µF ceramic capacitors are recommended.

Since C1 absorbs the input switching current, it requires an adequate ripple current rating. The RMS current in the input capacitor can be estimated with Equation (9):

$$I_{C1} = I_{LOAD} \times \sqrt{\frac{V_{OUT}}{V_{IN}} \times \left(1 - \frac{V_{OUT}}{V_{IN}}\right)} \quad (9)$$

The worst-case condition occurs at  $V_{IN} = 2V_{OUT}$ , shown in Equation (10):

$$I_{C1} = \frac{I_{LOAD}}{2} \quad (10)$$

For simplification, choose an input capacitor with an RMS current rating greater than half of the maximum load current.

The input capacitor can be electrolytic, tantalum, or ceramic. When using electrolytic or tantalum capacitors, add a small, high-quality ceramic capacitor (e.g.: 1µF) as close to the IC as possible. When using ceramic capacitors, ensure that they have enough capacitance to provide sufficient charge to prevent excessive voltage ripple at the input. The input voltage ripple caused by the capacitance can be estimated with Equation (11):

$$\Delta V_{IN} = \frac{I_{LOAD}}{f_s \times C1} \times \frac{V_{OUT}}{V_{IN}} \times \left(1 - \frac{V_{OUT}}{V_{IN}}\right) \quad (11)$$

### Selecting the Output Capacitor

The output capacitor (C2) maintains the DC output voltage. Use ceramic, tantalum, or low-ESR electrolytic capacitors. For best results, use low ESR capacitors to keep the output voltage ripple low. The output voltage ripple can be estimated with Equation (12):

$$\Delta V_{OUT} = \frac{V_{OUT}}{f_s \times L_1} \times \left(1 - \frac{V_{OUT}}{V_{IN}}\right) \times \left(R_{ESR} + \frac{1}{8 \times f_s \times C2}\right) \quad (12)$$

Where  $L_1$  is the inductor value and  $R_{ESR}$  is the equivalent series resistance (ESR) value of the output capacitor.

For ceramic capacitors, the capacitance dominates the impedance at the switching frequency, and the capacitance causes the majority of the output voltage ripple. For simplification, the output voltage ripple can be estimated with Equation (13):

$$\Delta V_{OUT} = \frac{V_{OUT}}{8 \times f_s^2 \times L_1 \times C2} \times \left(1 - \frac{V_{OUT}}{V_{IN}}\right) \quad (13)$$

For tantalum or electrolytic capacitors, the ESR dominates the impedance at the switching frequency. For simplification, the output ripple can be approximated with Equation (14):

$$\Delta V_{OUT} = \frac{V_{OUT}}{f_s \times L_1} \times \left(1 - \frac{V_{OUT}}{V_{IN}}\right) \times R_{ESR} \quad (14)$$

The characteristics of the output capacitor affect the stability of the regulation system. The MP2499M can be optimized for a wide range of capacitance and ESR values.

### BST Resistor and External BST Diode

A 20Ω resistor in series with the BST capacitor is recommended to reduce SW voltage spikes. A higher resistance is better for SW spike reduction, but compromises efficiency.

An external BST diode can enhance the efficiency of the regulator when the duty cycle is high (>65%). A power supply between 2.5V and 5V can be used to power the external bootstrap diode. VCC or VOUT is recommended for this power supply in the circuit (see Figure 8).

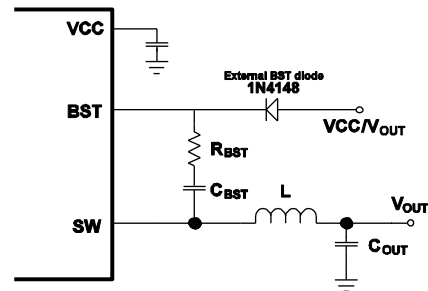

**Figure 8: Optional External Bootstrap Diode to Enhance Efficiency**

The recommended external BST diode is 1N4148, and the recommended BST capacitor value is 0.1µF to 1µF.



**PCB Layout Guidelines <sup>(7)</sup>**

Efficient PCB layout, especially of the input capacitor and VCC capacitor placement, is critical for stable operation. For best results, refer to Figure 9 and follow the guidelines below.

1. Place the ceramic input capacitors as close to IN and PGND as possible.
2. Keep the connection of the input capacitor and IN as short and wide as possible.
3. Place the VCC capacitor as close to VCC and AGND as possible.
4. Make the trace length of the VCC pin to the VCC capacitor anode to the VCC capacitor cathode to the chip's AGND pin as short as possible.
5. Use a large ground plane to connect to PGND directly.
6. Add vias near PGND if the bottom layer is a ground plane.
7. Route SW and BST away from sensitive analog areas such as FB.
8. Place the feedback resistor close to the chip to ensure that the trace connecting to FB is as short as possible.

**NOTE:**

- 7) The recommended layout is based on the Typical Application Circuit page 17.

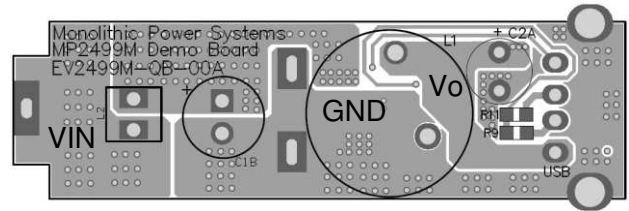
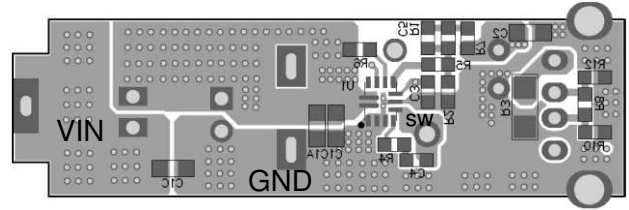
**Top Layer**

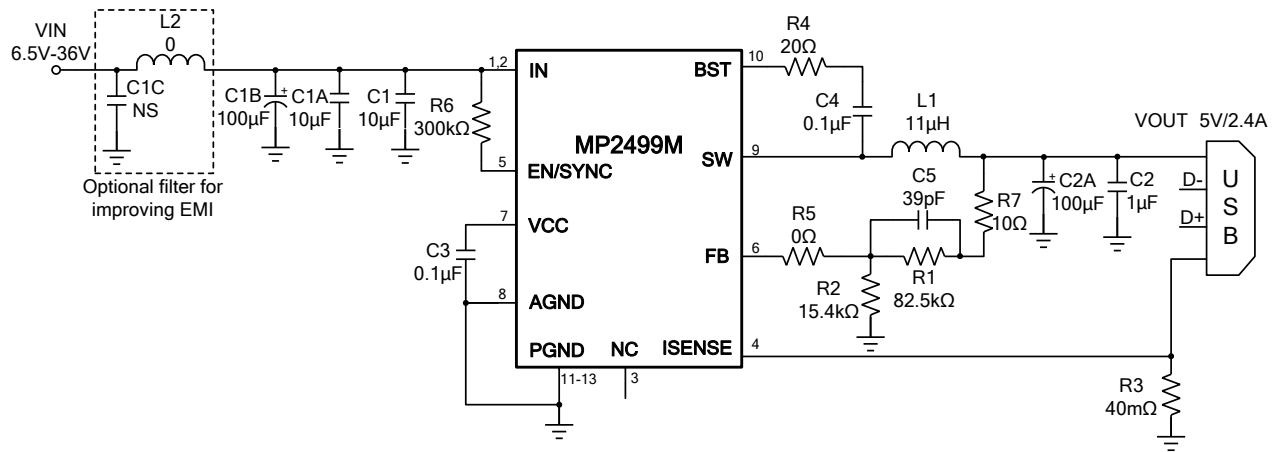
**Bottom Layer**
**Figure 9: Recommended PCB Layout**

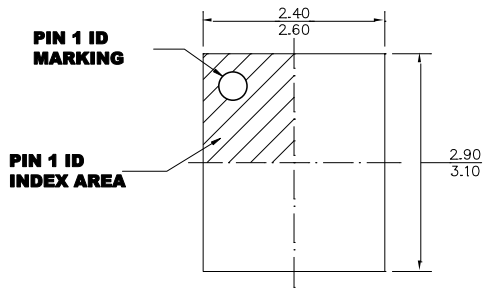
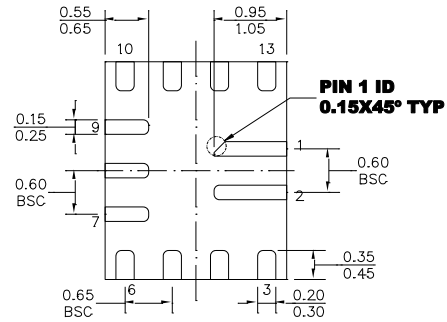
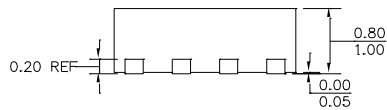
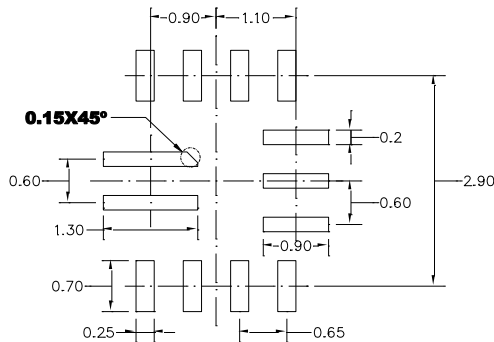
**TYPICAL APPLICATION CIRCUIT**

**Figure 10: CLA Typical Application Circuit**

**PACKAGE INFORMATION**
**QFN-13 (2.5mmx3mm)**

**TOP VIEW**

**BOTTOM VIEW**

**SIDE VIEW**

**RECOMMENDED LAND PATTERN**
**NOTE:**

- 1) ALL DIMENSIONS ARE IN MILLIMETERS.
- 2) LEAD COPLANARITY SHALL BE 0.10 MILLIMETERS MAX.
- 3) JEDEC REFERENCE IS MO-220.
- 4) DRAWING IS NOT TO SCALE.

**NOTICE:** The information in this document is subject to change without notice. Please contact MPS for current specifications. Users should warrant and guarantee that third party Intellectual Property rights are not infringed upon when integrating MPS products into any application. MPS will not assume any legal responsibility for any said applications.