



Chipsmall Limited consists of a professional team with an average of over 10 year of expertise in the distribution of electronic components. Based in Hongkong, we have already established firm and mutual-benefit business relationships with customers from,Europe,America and south Asia,supplying obsolete and hard-to-find components to meet their specific needs.

With the principle of “Quality Parts,Customers Priority,Honest Operation,and Considerate Service”,our business mainly focus on the distribution of electronic components. Line cards we deal with include Microchip,ALPS,ROHM,Xilinx,Pulse,ON,Everlight and Freescale. Main products comprise IC,Modules,Potentiometer,IC Socket,Relay,Connector.Our parts cover such applications as commercial,industrial, and automotives areas.

We are looking forward to setting up business relationship with you and hope to provide you with the best service and solution. Let us make a better world for our industry!



Contact us

Tel: +86-755-8981 8866 Fax: +86-755-8427 6832

Email & Skype: info@chipsmall.com Web: www.chipsmall.com

Address: A1208, Overseas Decoration Building, #122 Zhenhua RD., Futian, Shenzhen, China



DESCRIPTION

The MP2632 is a highly integrated, flexible, switch-mode battery charger with system power-path management and is designed for single-cell Li-ion or Li-polymer battery use in a wide range of applications.

The IC can operate in both charge mode and boost mode to allow for full system and battery power management.

The IC has an integrated IN-to-SYS pass-through path to pass the input voltage to the system. The pass-through path has built-in over-voltage and over-current protection and has a higher priority over the charging path.

When the input power is present, the device operates in charge mode. The MP2632 detects the battery voltage automatically and charges the battery in three phases: trickle current, constant current and constant voltage. Other features include charge termination and auto-recharge. The MP2632 also integrates both input current limit and input voltage regulation to manage input power and meet the priority of the system power demand.

In the absence of an input source, the IC switches to boost mode through PB to power SYS from the battery. In boost mode, OLIM programs the output current limit, and the IC turns off at light load automatically. The IC also uses output short-circuit protection to disconnect the battery from the load completely in the event of a short-circuit fault. The MP2632 resumes normal operation once the short-circuit fault is removed.

The 4-LED driver is integrated for voltage-based fuel gauge indication. Together with torch-light control, the MP2632 provides an all-in-one solution for power banks and similar applications without an external micro-controller.

The MP2632 is available in a 26-pin QFN (4mmx4mm) package.

FEATURES

- Up to 14V Sustainable Input Voltage
- 4.65V to 6V Operating Input Voltage Range
- Power Management Function, Integrated Input Current Limit, Input Voltage Regulation
- Up to 3A Programmable Charge Current
- Trickle-Charge Function
- Selectable 4.2V/4.35V/4.45V Charge Voltage with 0.5% Accuracy
- 4-LED Driver for Battery Fuel Gauge Indication
- Automatic Turn-Off at Light Load
- Input Source Detection
- Output Source Signaling
- Torch-Light Control
- Negative Temperature Coefficient Pin for Battery Temperature Monitoring
- Programmable Timer Back-Up Protection
- Thermal Regulation and Thermal Shutdown
- Internal Battery Reverse Leakage Blocking
- Integrated Over-Voltage Protection (OVP) and Over-Current Protection (OCP) for Pass-Through Path
- Reverse Boost Operation Mode for System Power
- Up to 3.0A Programmable Output Current Limit for Boost Mode
- Integrated Short-Circuit Protection (SCP) and Output Over-Voltage Protection for Boost Mode

APPLICATIONS

- Sub-Battery Applications
- Power-Bank Applications for Smart Phones
- Tablets and Other Portable Devices

All MPS parts are lead-free, halogen-free, and adhere to the RoHS directive. For MPS green status, please visit the MPS website under Quality Assurance. "MPS" and "The Future of Analog IC Technology" are registered trademarks of Monolithic Power Systems, Inc.

Analog Digital Adaptive Modulation (ADAM) is a trademark of Monolithic Power Systems, Inc.

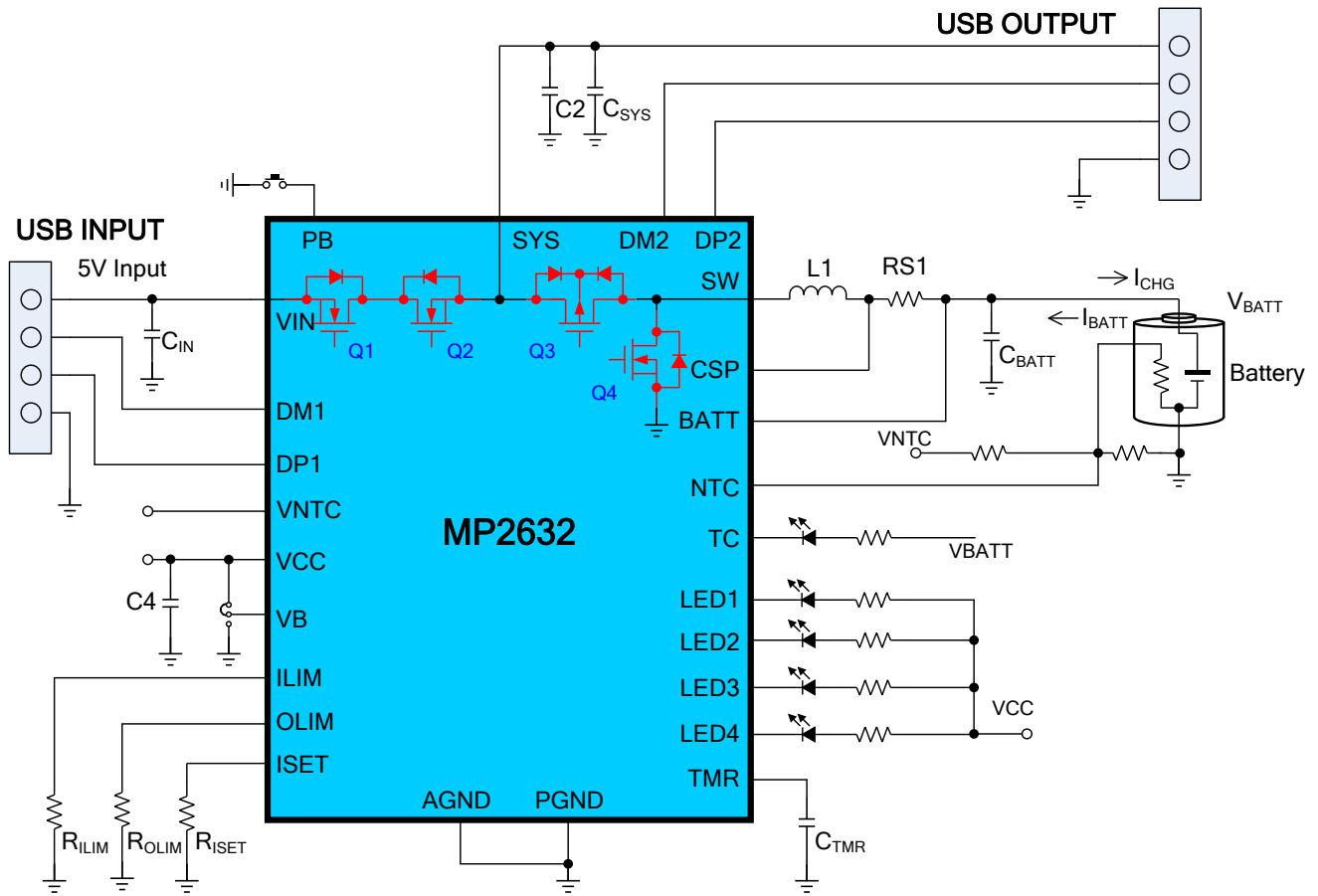
TYPICAL APPLICATION

Table 1: Operation Mode Control

V_{IN} (V)	PB	Operation Mode	Q1, Q2	Q3	Q4
$V_{BATT} + 300mV < V_{IN} < 6V$	X	Charging	On	SW	SW
$V_{IN} < V_{BATT} + 300mV$	From H to L for $>1.5ms$	Discharging (boost)	Off	SW	SW
$V_{IN} > 6V$	X	OVP	Off	Off	Off
$V_{IN} < 2V$	H or L	Sleep	Off	Off	Off

ORDERING INFORMATION

Part Number*	Package	Top Marking
MP2632GR	QFN-26 (4mmx4mm)	<i>See Below</i>

* For Tape & Reel, add suffix -Z (e.g. MP2632GR-Z)

TOP MARKING

MPSYWW

MP2632

LLLLLL

MPS: MPS prefix
 Y: Year code
 WW: Week code
 MP2632: Product code of MP2632GR
 LLLLLL: Lot number

PACKAGE REFERENCE

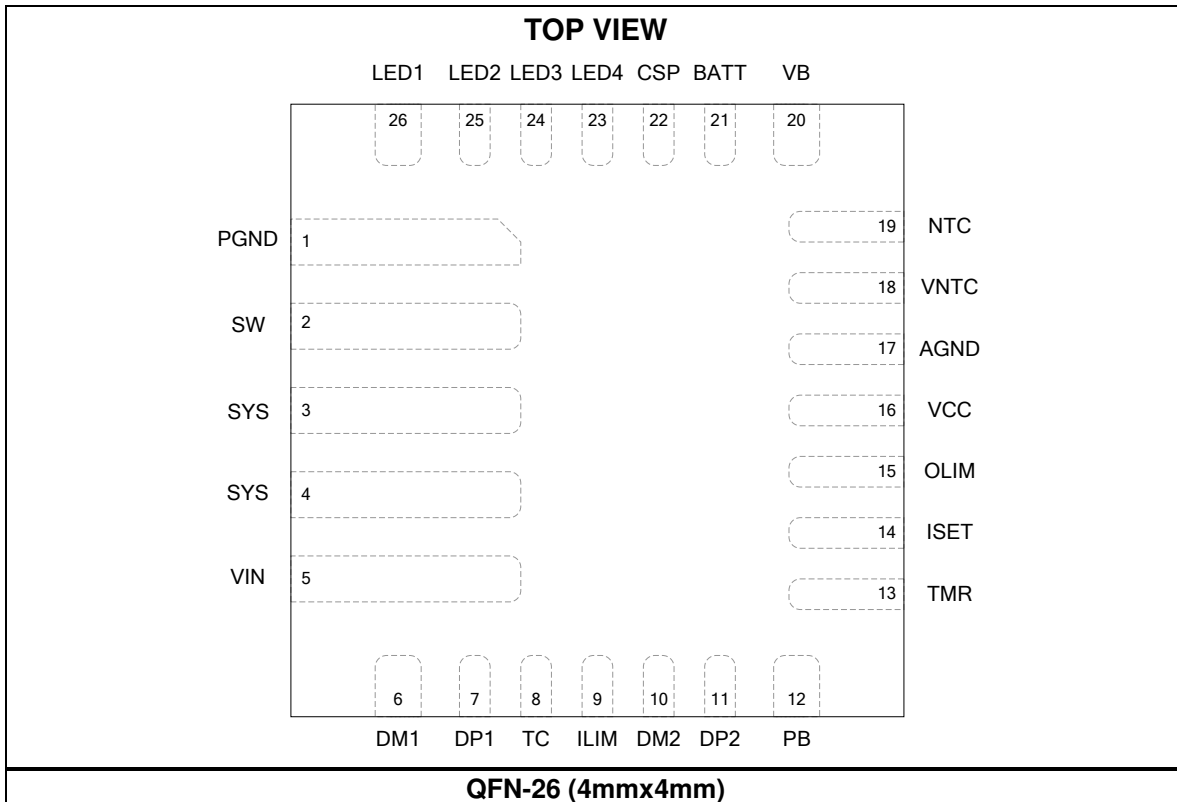

ABSOLUTE MAXIMUM RATINGS ⁽¹⁾

VIN to PGND	-0.3V to +14V
SYS to PGND	-0.3V to +6.5V
SW to PGND	-0.3V (-2V for 20ns) to +6.5V
BATT to PGND.....	-0.3V to +6.5V
All other pins to AGND.....	-0.3V to +6.5V
Continuous power dissipation (T _A = +25°C) ⁽²⁾ ...	2.84W
Junction temperature	150°C
Lead temperature (solder)	260°C
Storage temperature.....	-65°C to +150°C

Recommended Operating Conditions ⁽³⁾

Supply voltage (V _{IN})	4.65V to +6V
I _{IN}	Up to 3A
I _{SYS}	Up to 3A
I _{CHG}	Up to 3A
V _{BATT}	Up to 4.45V
Operating junction temp. (T _J) ...	-40°C to +125°C

Thermal Resistance ⁽⁴⁾	θ_{JA}	θ_{JC}
QFN-26 (4mmx4mm).....	44	9 °C/W

NOTES:

- 1) Exceeding these ratings may damage the device.
- 2) The maximum allowable power dissipation is a function of the maximum junction temperature T_J (MAX), the junction-to-ambient thermal resistance θ_{JA}, and the ambient temperature T_A. The maximum allowable continuous power dissipation at any ambient temperature is calculated by P_D (MAX) = (T_J (MAX)-T_A)/θ_{JA}. Exceeding the maximum allowable power dissipation produces an excessive die temperature, causing the regulator to go into thermal shutdown. Internal thermal shutdown circuitry protects the device from permanent damage.
- 3) The device is not guaranteed to function outside of its operating conditions.
- 4) Measured on JESD51-7, 4-layer PCB.

ELECTRICAL CHARACTERISTICS

$V_{IN} = 5.0V$, $R_{S1} = 10m\Omega$, $T_A = +25^\circ C$, unless otherwise noted.

Parameter	Symbol	Condition	Min	Typ	Max	Units
IN-to-SYS NMOS on resistance	$R_{IN\ to\ SYS}$	$V_{CC} = 5V$	49	55	62	m Ω
High-side PMOS on resistance	R_{H_DS}	$V_{CC} = 5V$	20	26	31	m Ω
Low-side NMOS on resistance	R_{L_DS}	$V_{CC} = 5V$	20	26	31	m Ω
High-side PMOS peak current limit	I_{PEAK_HS}	CC charge mode/boost mode	5.7	7	8.4	A
		TC charge mode	1.9	2.3	2.8	A
Low-side NMOS peak current limit	I_{PEAK_LS}		6.4	8	9.6	A
Switching frequency	F_{sw}		500	600	800	kHz
VCC UVLO	$V_{CC\ UVLO}$		1.96	2.16	2.36	V
VCC UVLO hysteresis				100		mV
Charge Mode						
Input quiescent current	I_{Q_IN}	Charge mode, $I_{SYS} = 0$, battery float		1.8	2.5	mA
Input current limit for DCP	I_{IN_LIMIT}	$R_{ILIM} = 88.7k$	380	435	490	mA
		$R_{ILIM} = 49.9k$	740	820	900	
		$R_{ILIM} = 14.7k$	2580	2840	3100	
Input current limit for SDP	I_{USB}	SDP is detected using DP1/DM1 detection	400	450	500	mA
Input over-voltage protection	V_{IN_OVP}	V_{IN} rising	5.8	6.0	6.2	V
V_{IN_OVP} hysteresis		V_{IN} falling		250		mV
Input under-voltage lockout	V_{IN_UVLO}	V_{IN} rising	3.3	3.45	3.6	V
V_{UVLO} hysteresis		V_{IN} falling		155		mV
Input over-current threshold	I_{IN_OCP}			5		A
Input over-current blanking time ⁽⁵⁾	$T_{INOCBLK}$			200		μs
Input over-current recover time ⁽⁵⁾	$T_{INRECVR}$			150		ms
Terminal battery voltage	V_{BATT_FULL}	Connect VB to GND	4.328	4.35	4.372	V
		Leave VB floating	4.179	4.2	4.221	
		Connect VB to VCC	4.428	4.45	4.472	
Recharge threshold	V_{RECH}	Connect to VB to GND	4.1	4.16	4.22	V
		Leave VB floating	3.95	4.02	4.08	
		Connect VB to VCC	4.19	4.26	4.32	
Trickle charge voltage threshold	V_{BATT_TC}	Connect VB to GND	3	3.07	3.13	V
		Leave VB floating	2.9	2.96	3.02	
		Connect VB to VCC	3.07	3.14	3.2	

ELECTRICAL CHARACTERISTICS *(continued)*
 $V_{IN} = 5.0V$, $R_{S1} = 10m\Omega$, $T_A = +25^\circ C$, unless otherwise noted.

Parameter	Symbol	Condition	Min	Typ	Max	Units
Trickle charge hysteresis				220		mV
Battery over-voltage threshold	V_{BOVP}	As a percentage of V_{BATT_FULL}	101.5%	103.5%	105.5%	V_{BATT_FULL}
Constant charge (CC) current	I_{CC}	$R_{S1} = 10m\Omega$, $R_{ISET} = 150k$	900	1000	1100	mA
		$R_{S1} = 10m\Omega$, $R_{ISET} = 75k$	1800	2000	2200	
		$R_{S1} = 10m\Omega$, $R_{ISET} = 49.9k$	2700	3000	3300	
Trickle charge current	I_{TC}		90	280	400	mA
Termination charge current	I_{BF}	$R_{S1} = 10m\Omega$	90	200	300	mA
Input voltage regulation reference	V_{REG}		4.55	4.65	4.75	V
Boost Mode						
SYS voltage range		$I_{SYS} = 100mA$	5	5.1	5.2	V
Boost SYS over-voltage protection threshold	$V_{SYS(OVP)}$	Threshold over V_{SYS} to turn off the converter during boost mode	5.6	5.8	6	V
SYS over-voltage protection threshold hysteresis		V_{SYS} falling from $V_{SYS(OVP)}$		330		mV
Boost quiescent current	I_{Q_BOOST}	$I_{SYS} = 0$, boost mode, in test mode with auto-off disabled			1.65	mA
Programmable boost output current-limit accuracy	I_{OLIM}	$R_{S1} = 10m\Omega$, $R_{OLIM} = 150k$	0.9	1	1.1	A
		$R_{S1} = 10m\Omega$, $R_{OLIM} = 60.4k$	2.34	2.5	2.66	
		$R_{S1} = 10m\Omega$, $R_{OLIM} = 49.9k$	2.8	3	3.2	
SYS over-current blanking time ⁽⁵⁾	$T_{SYSOCBLK}$			150		μs
SYS over-current recover time ⁽⁵⁾	$T_{SYSRECVR}$			1.5		ms
System load to turn off boost	I_{NOLOAD}	Battery current in boost mode	50	85	120	mA
Light-load blanking time ⁽⁵⁾				16		s
Weak battery threshold	V_{BAT_UVLO}	During boost		2.5	2.6	V
		Before boost starts		2.9	3.05	V
Sleep Mode						
Battery leakage current	$I_{LEAKAGE}$	$V_{BATT} = 4.2V$, SYS float, $V_{IN} = 0V$, not in boost mode		13	16	μA

ELECTRICAL CHARACTERISTICS *(continued)*
 $V_{IN} = 5.0V$, $R_{S1} = 10m\Omega$, $T_A = +25^{\circ}C$, unless otherwise noted.

Parameter	Symbol	Condition	Min	Typ	Max	Units
Indication and Logic						
LED1, LED2, LED3, and LED4 output low voltage		Sinking 5mA			200	mV
TC output low voltage		Sinking 100mA			550	mV
LED1, LED2, LED3, LED4, TC leakage current		Connected to 5V			0.2	μA
INOVP, BOVP and NTC, fault blinking frequency ⁽⁵⁾				1		Hz
PB input logic low voltage					0.4	V
PB input logic high voltage			1.4			V
Protection						
Trickle charge time		$C_{TMR} = 0.1\mu F$, remains in TC mode, $I_{TC} = 250mA$		16		Min
Total charge time		$C_{TMR} = 0.1\mu F$, $I_{CHG} = 1A$		390		Min
NTC low temp, rising threshold		$R_{NTC} = NCP18XH103(0^{\circ}C)$	65.2%	66.2%	67.2%	V_{SYS}
NTC low temp, rising threshold hysteresis			2.4%			
NTC high temp, rising threshold		$R_{NTC} = NCP18XH103(50^{\circ}C)$	34.7%	35.7%	36.7%	
NTC high temp, rising threshold hysteresis			2%			
Charging current foldback threshold ⁽⁵⁾		Charge mode		120		$^{\circ}C$
Thermal shutdown threshold ⁽⁵⁾				150		$^{\circ}C$
Input DP1/DM1 USB Detection						
DP1 voltage source	V_{DP_SRC}		0.5	0.6	0.7	V
Data connect detect current source	I_{DP_SRC}		7		13	μA
DM1 sink current	I_{DM_SINK}		50	100	150	μA
Leakage current input DP1/DM1	I_{DP_LKG}		-1		1	MA
	I_{DM_LKG}		-1		1	MA
Data detect voltage	V_{DAT_REF}		0.25		0.4	V
Logic low (logic threshold)	V_{LGC_LOW}				0.8	V
DM pull-down resistor				19		K Ω
Logic I/O Characteristics						
Low-logic voltage threshold	V_L				0.4	V
High-logic voltage threshold	V_H		1.3			V

ELECTRICAL CHARACTERISTICS *(continued)*

$V_{IN} = 5.0V$, $R_{S1} = 10m\Omega$, $T_A = +25^\circ C$, unless otherwise noted.

Parameter	Symbol	Condition	Min	Typ	Max	Units
Output DP2/DM2 USB Signaling						
BC1.2 DCP Mode						
DP2 and DM2 short resistance		$V_{DP} = 0.8V$, $I_{DM} = 1mA$		158	200	Ω
BC1.2 SDP Mode						
DP2 pull-down resistance			11	15	19	k Ω
DM2 pull-down resistance			11	15	19	k Ω
Divider Mode						
DP2 output voltage		$V_{OUT} = 5V$	2.6	2.7	2.8	V
DM2 output voltage		$V_{OUT} = 5V$	2.6	2.7	2.8	V
DP2/DM2 output impedance			26	31	36	k Ω
1.2V/1.2V Mode						
DP2/DM2 output voltage		$V_{OUT} = 5V$	1.21	1.26	1.31	V
DP2/DM2 output impedance			60	78	90	k Ω
Voltage-Based Fuel Gauge ($V_{OREG} = 4.2V$, Charge Mode)						
First level of battery voltage threshold			3.52	3.6	3.69	V
Hysteresis				500		mV
Second level of battery voltage threshold			3.7	3.8	3.91	V
Hysteresis				500		mV
Third level of battery voltage threshold			3.92	4.0	4.11	V
Hysteresis				500		mV
Voltage-Based Fuel Gauge ($V_{OREG} = 4.2V$, Discharge Mode)						
First level of battery voltage threshold			3.4	3.47	3.54	V
Hysteresis				500		mV
Second level of battery voltage threshold			3.55	3.62	3.69	V
Hysteresis				500		mV
Third level of battery voltage threshold			3.7	3.77	3.84	V
Hysteresis				500		mV
Fourth level of battery voltage threshold			3.85	3.92	3.99	V
Hysteresis				500		mV

NOTE:

5) Guaranteed by design.

TYPICAL PERFORMANCE CHARACTERISTICS

$V_{IN} = 5V$, $C_{IN} = C_{BATT} = C_{SYS} = C_2 = 22\mu F$, $L_1 = 2.2\mu H$, $R_{S1} = 10m\Omega$, $C_4 = C_{TMR} = 0.1\mu F$, battery simulator, unless otherwise noted.

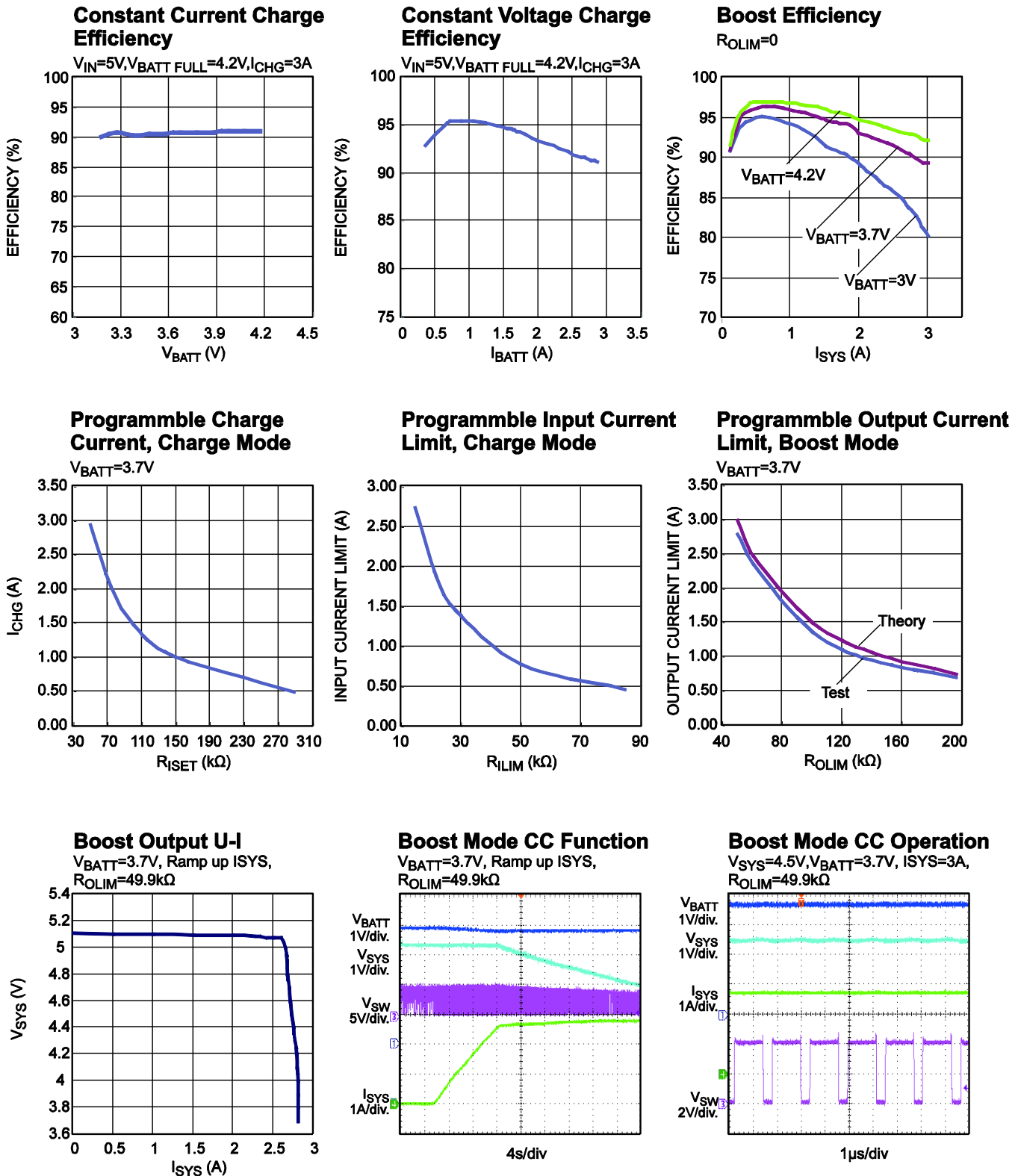

TYPICAL PERFORMANCE CHARACTERISTICS *(continued)*

$V_{IN} = 5V$, $C_{IN} = C_{BATT} = C_{SYS} = C_2 = 22\mu F$, $L_1 = 2.2\mu H$, $RS1 = 10m\Omega$, $C_4 = C_{TMR} = 0.1\mu F$, battery simulator, unless otherwise noted.

Battery Charge Curve

$V_{BATT_FULL} = 4.2V$, $I_{SYS} = 0A$, $I_{CHG} = 3.0A$

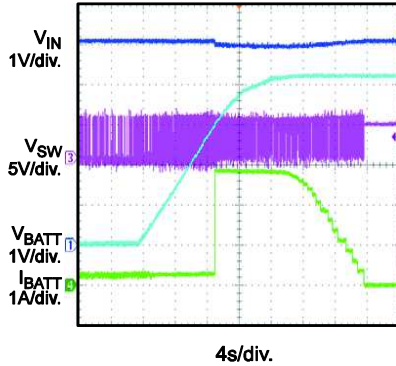

Auto-Recharge

$V_{BATT_FULL} = 4.2V$, $I_{SYS} = 0A$, $I_{CHG} = 3.0A$

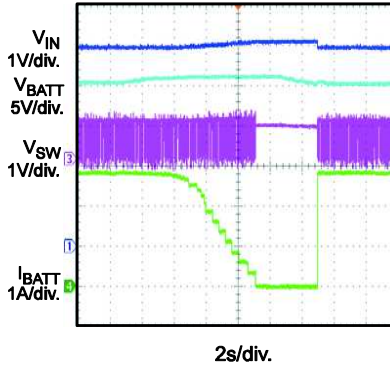

Indication during Charging

$V_{BATT_FULL} = 4.2V$, $I_{SYS} = 0A$, $I_{CHG} = 3.0A$

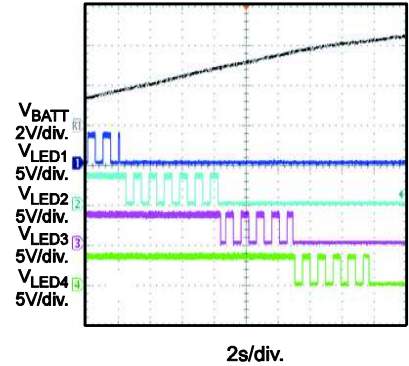

BATT Float Steady State

$V_{BATT_FULL} = 4.2V$, $I_{SYS} = 0A$

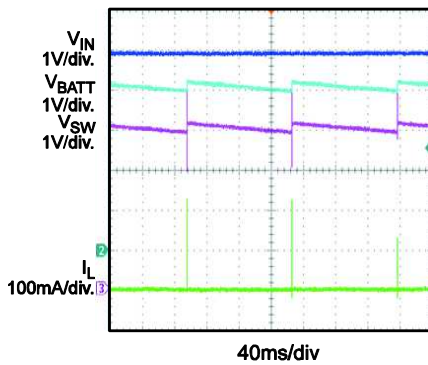

TC Charge Steady State

$V_{BATT_FULL} = 4.2V$, $I_{SYS} = 0A$,
 $V_{BATT} = 2.6V$

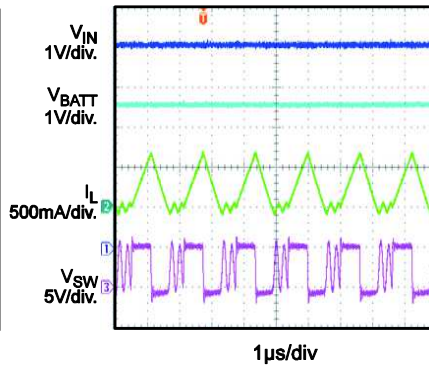

CC Charge Steady State

$V_{BATT_FULL} = 4.2V$, $I_{SYS} = 0A$,
 $V_{BATT} = 3.7V$

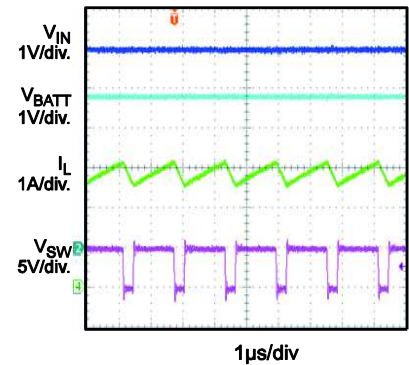

CV Charge Steady State

$V_{BATT_FULL} = 4.2V$, $I_{SYS} = 0A$,
 $V_{BATT} = 4.2V$

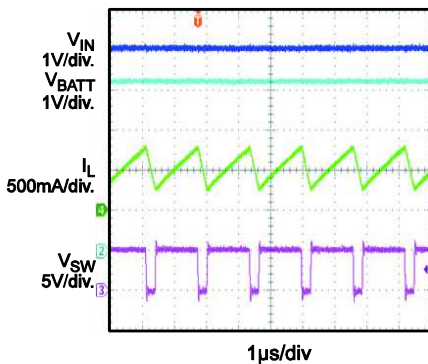

Power On, Charge Mode

$V_{BATT_FULL} = 4.2V$, $I_{SYS} = 0A$,
 $V_{BATT} = 3.7V$

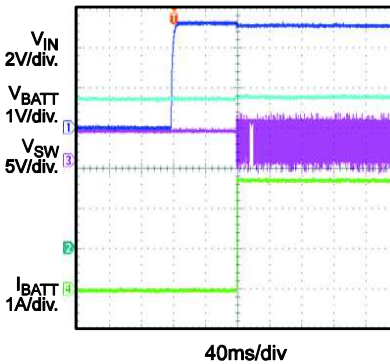

Power Off, Charge Mode

$V_{BATT_FULL} = 4.2V$, $I_{SYS} = 0A$,
 $V_{BATT} = 3.7V$

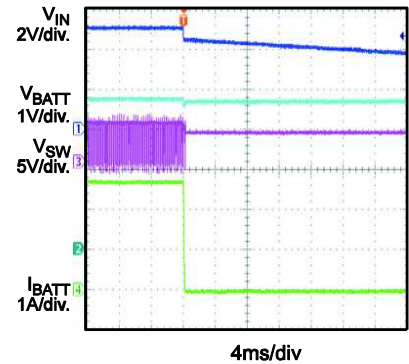

TYPICAL PERFORMANCE CHARACTERISTICS *(continued)*

$V_{IN} = 5V$, $C_{IN} = C_{BATT} = C_{SYS} = C_2 = 22\mu F$, $L_1 = 2.2\mu H$, $R_{S1} = 10m\Omega$, $C_4 = C_{TMR} = 0.1\mu F$, battery simulator, unless otherwise noted.

Input Current Limit

$V_{BATT_FULL} = 4.2V$, $V_{BATT} = 3.7V$,
 $R_{ILIMIT} = 14.7k\Omega$

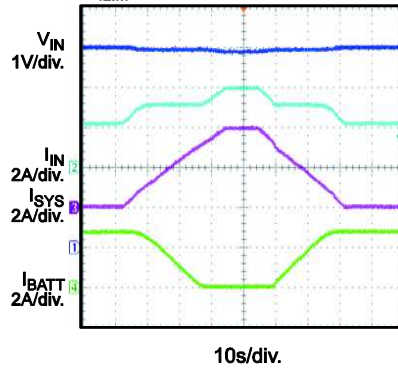

Input Voltage Regulation

$V_{BATT_FULL} = 4.2V$, $V_{BATT} = 3.7V$,
 $V_{IN_REG} = 4.65V$

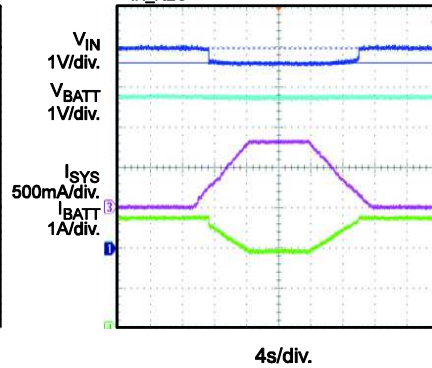

Input Over-Voltage Protection

$V_{IN} = 5V$ to $6V$, $V_{BATT} = 3.7V$

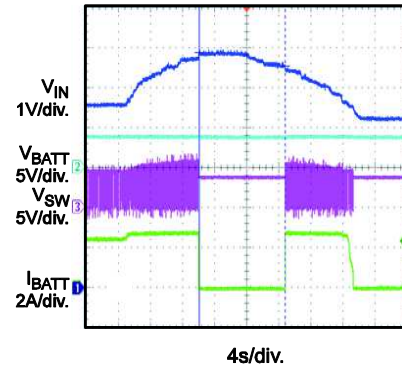

Input Over-Current Protection

$V_{IN} = 5V$, Ramp up I_{SYS} to $4.2A$,
 $V_{BATT} = 3.7V$

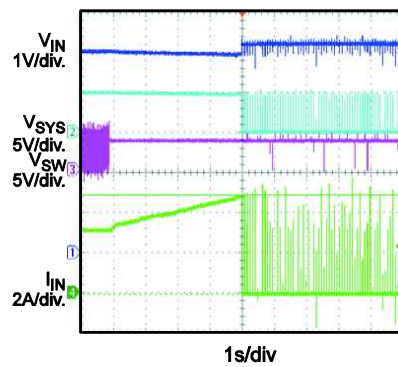

NTC Protection, Charge Mode

$V_{IN} = 5V$, $V_{BATT} = 2.6V$

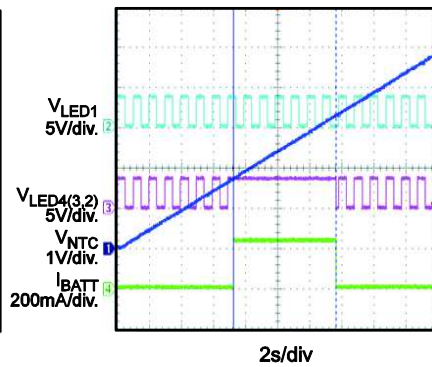

Timer Out Protection, Charge Mode

$V_{IN} = 5V$, $V_{BATT} = 3.7V$, $C_{TMR} = 150pF$

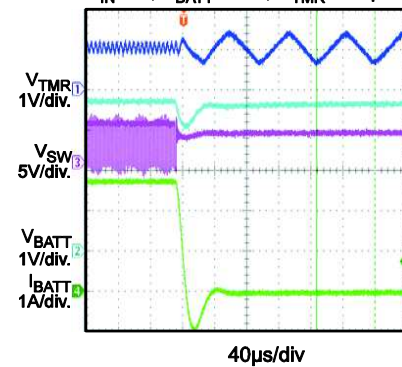

Boost Automatic On, Phone Insertion

$V_{BATT} = 4V$

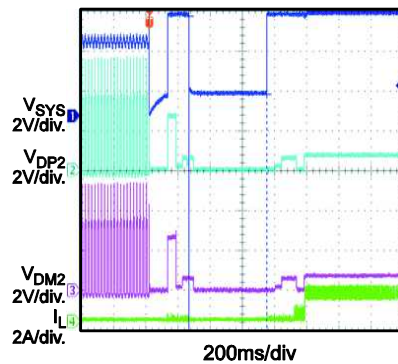

Input Adapter Insertion, No Load Connection

$V_{BATT} = 3.7V$, $R_{LIMIT} = 14.7k\Omega$,
 $R_{ISET} = 49.9k\Omega$

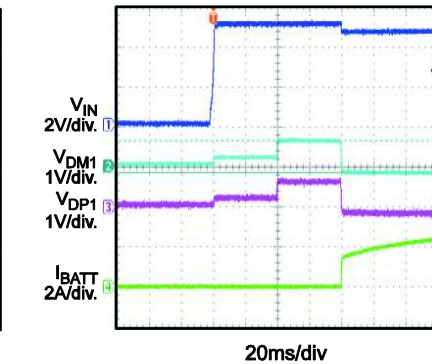

Input Adapter Insertion, Phone Connected

$V_{BATT} = 3.7V$, $R_{LIMIT} = 14.7k\Omega$,
 $R_{ISET} = 49.9k\Omega$

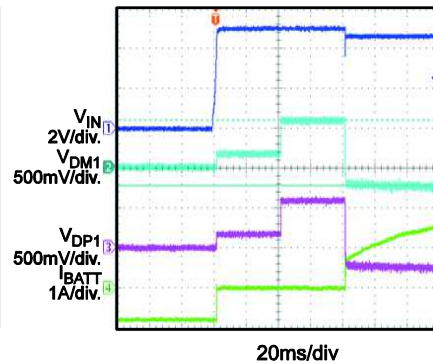

TYPICAL PERFORMANCE CHARACTERISTICS *(continued)*

$V_{IN} = 5V$, $C_{IN} = C_{BATT} = C_{SYS} = C_2 = 22\mu F$, $L_1 = 2.2\mu H$, $R_{S1} = 10m\Omega$, $C_4 = C_{TMR} = 0.1\mu F$, battery simulator, unless otherwise noted.

Input Adapter Removal, Phone Connected

$V_{BATT}=3.7V$, $R_{LIMIT}=14.7k$, $R_{ISET}=49.9k$

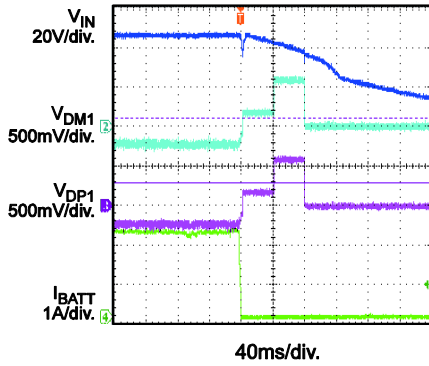

USB Insertion, No Load Connection

$V_{BATT}=3.7V$, $R_{LIMIT}=14.7k$, $R_{ISET}=49.9k$

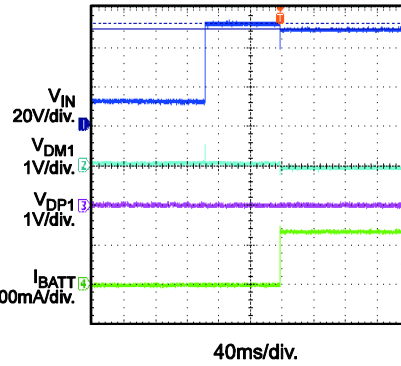

USB Removal, No Load Connection

$V_{BATT}=3.7V$, $R_{LIMIT}=14.7k$, $R_{ISET}=49.9k$

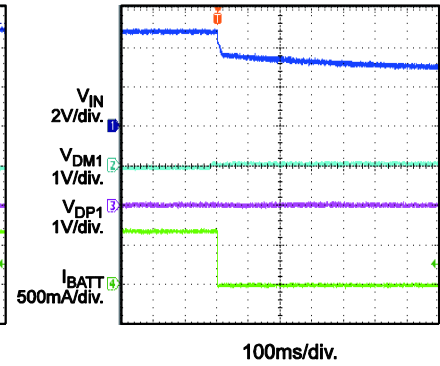

USB Insertion, Phone Connected

$V_{BATT}=3.7V$, $R_{LIMIT}=14.7k$, $R_{ISET}=49.9k$

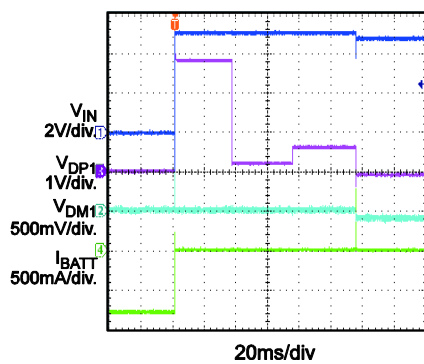

USB Removal, Phone Connected

$V_{BATT}=3.7V$, $R_{LIMIT}=14.7k$, $R_{ISET}=49.9k$

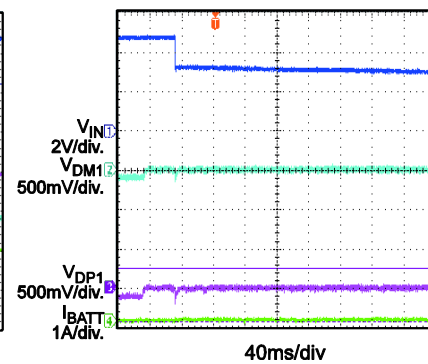

Phone Connected, Charging from Adapter

$V_{BATT}=3.7V$, $R_{LIMIT}=14.7k$, $R_{ISET}=49.9k$

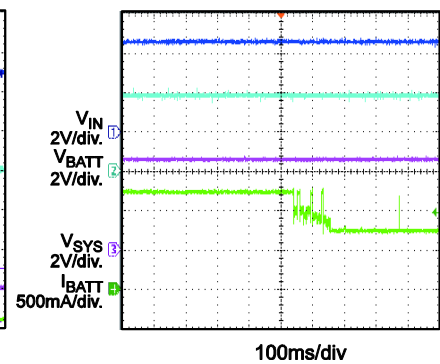

Phone Removed, Charging from Adapter

$V_{BATT}=3.7V$, $R_{LIMIT}=14.7k$, $R_{ISET}=49.9k$

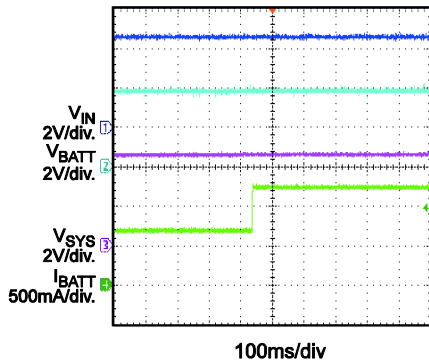

Phone Connected, Charging from USB

$V_{BATT}=3.7V$, $R_{LIMIT}=14.7k$, $R_{ISET}=49.9k$

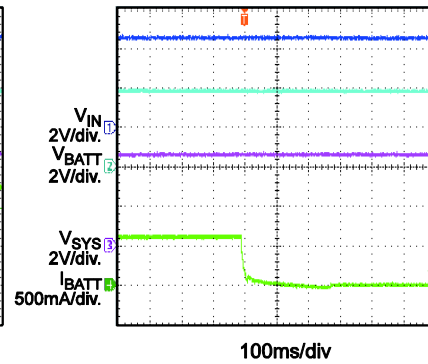

Phone Removed, Charging from USB

$V_{BATT}=3.7V$, $R_{LIMIT}=14.7k$, $R_{ISET}=49.9k$

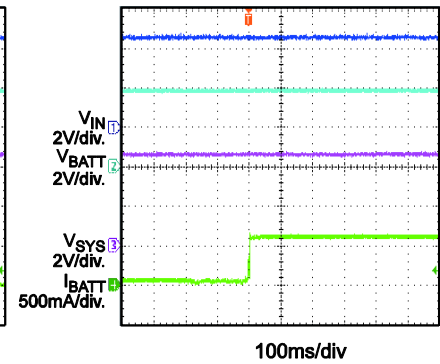

TYPICAL PERFORMANCE CHARACTERISTICS *(continued)*

$V_{IN} = 5V$, $C_{IN} = C_{BATT} = C_{SYS} = C_2 = 22\mu F$, $L_1 = 2.2\mu H$, $RS1 = 10m\Omega$, $C_4 = C_{TMR} = 0.1\mu F$, battery simulator, unless otherwise noted.

Boost Mode Steady State

$V_{BATT}=3.7V$, $I_{SYS}=3A$

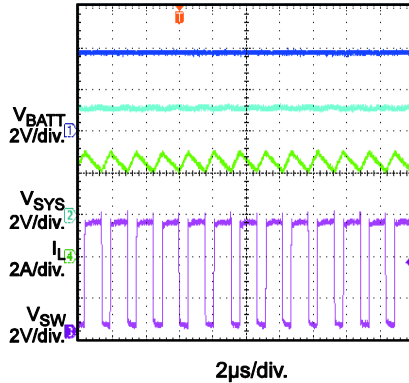

Power On by PB, Boost Mode

$V_{BATT}=3.7V$, $I_{SYS}=0A$

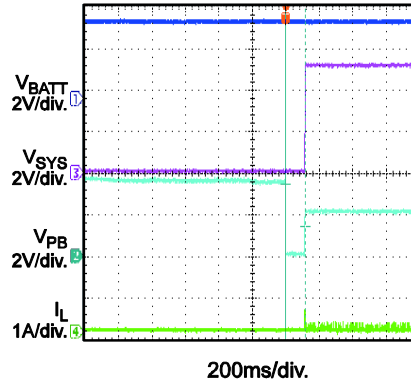

Power Off by PB, Boost Mode

$V_{BATT}=3.7V$, $I_{SYS}=0A$

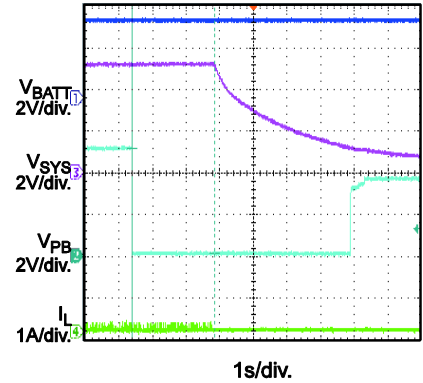

Power Off by Battery Removal, Boost Mode

$V_{BATT}=3.7V$, $I_{SYS}=0A$

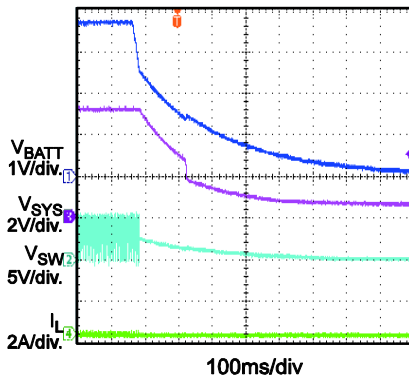

Power On by PB, Boost Mode

$V_{BATT}=3.7V$, $I_{SYS}=3A$

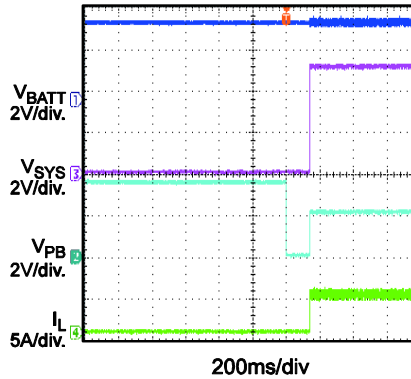

Power Off by PB, Boost Mode

$V_{BATT}=3.7V$, $I_{SYS}=3A$

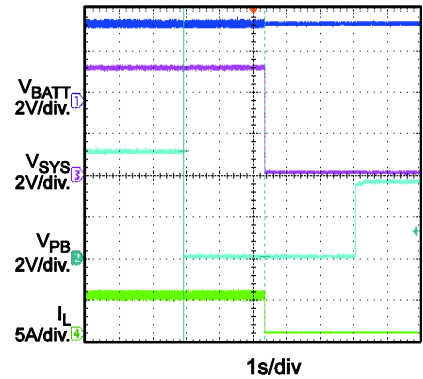

Power Off by Battery Removal, Boost Mode

$V_{BATT}=3.7V$, $I_{SYS}=2.5A$

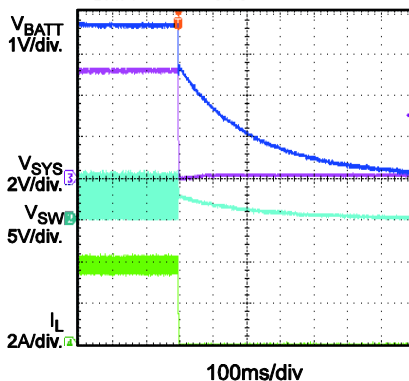

SYS Output Current Limit, Boost Mode

$V_{BATT}=3.7V$, $R_{OLIM}=60.4k\Omega$

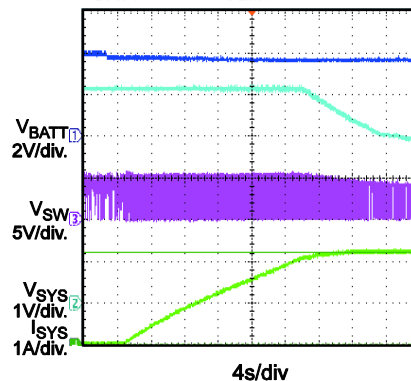

Auto Restart after SYS OCP, Boost Mode

$V_{BATT}=3.0V$, $R_{OLIM}=100k\Omega$

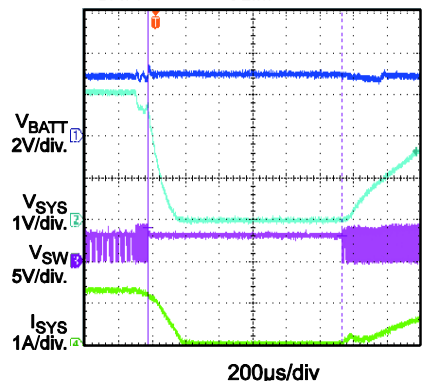

TYPICAL PERFORMANCE CHARACTERISTICS *(continued)*

$V_{IN} = 5V$, $C_{IN} = C_{BATT} = C_{SYS} = C_2 = 22\mu F$, $L_1 = 2.2\mu H$, $RS1 = 10m\Omega$, $C_4 = C_{TMR} = 0.1\mu F$, battery simulator, unless otherwise noted.

Light-Load Off Test

$V_{BATT}=4.5V$, $I_{BATT}=55mA$

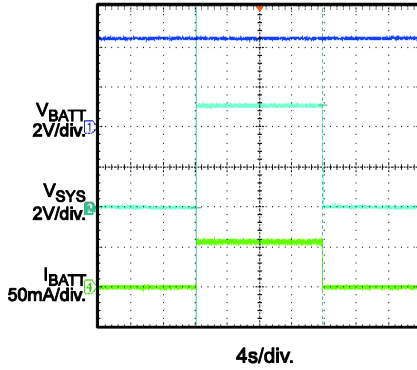

Light-Load Off Test

$V_{BATT}=3.0V$, $I_{BATT}=65mA$

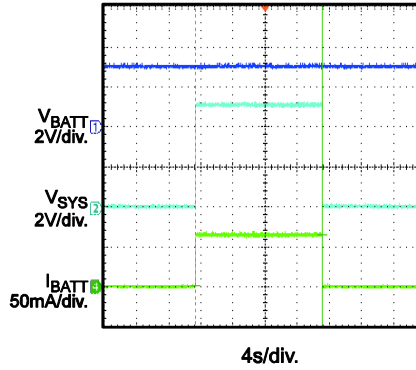

Load Transient

$V_{BATT}=4.2V$, $I_{SYS}=0.5A-2.5A$

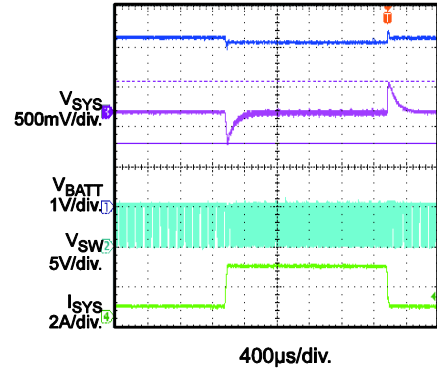

SYS Short-Circuit Entry

$V_{BATT}=3.7V$, $I_{SYS}=3A$

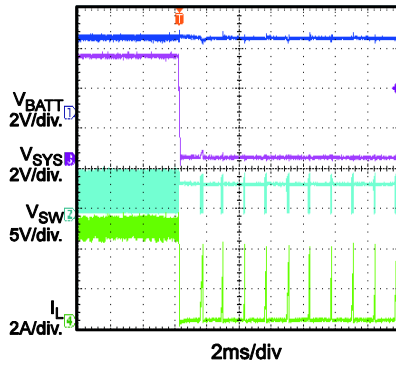

SYS Short Steady

$V_{BATT}=3.7V$, $I_{SYS}=3A$

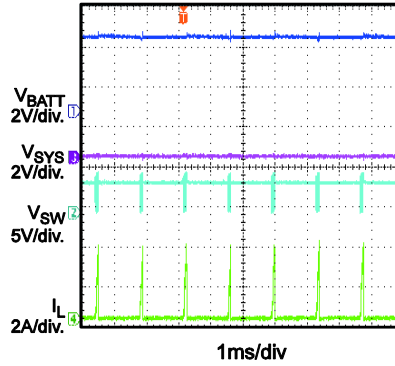

SYS Short-Circuit Recovery

$V_{BATT}=3.7V$, $I_{SYS}=3A$

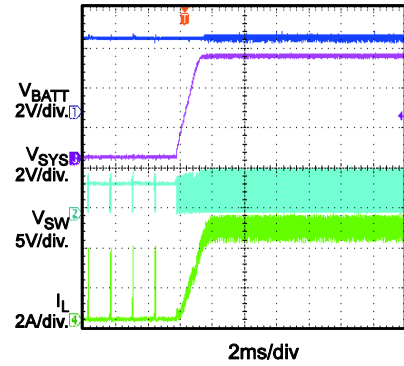

LED Indication during Discharging

V_{BATT} ramping down, $I_{SYS}=3A$

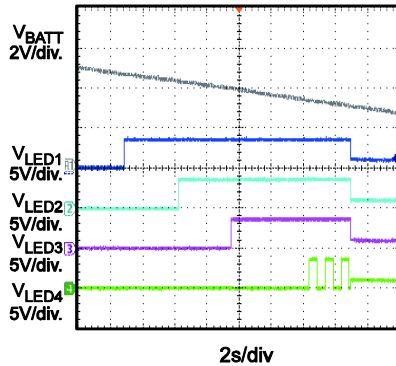

NTC Protection, Boost Mode

$V_{BATT}=3.7V$, $I_{SYS}=1A$

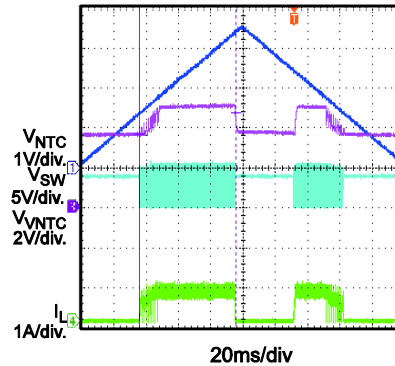

Torch Light

$V_{BATT}=4.2V$

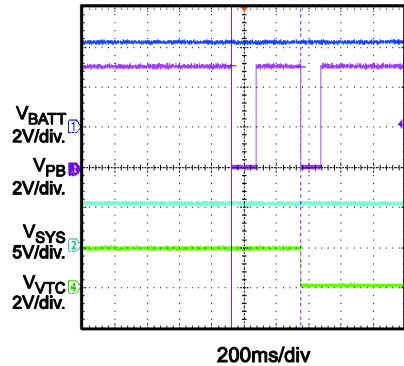

PIN FUNCTIONS

P/N	Name	I/O	Description
1	PGND	Power	Power ground.
2	SW	Power	Switch output node. It is not recommended to place vias on the SW plane during PCB layout.
3, 4	SYS	Power	System output. Place a ceramic capacitor of at least 22 μ F as close to SYS and PGND as possible. The total capacitance should not be lower than 44 μ F.
5	VIN	Power	Adapter input. Place a bypass capacitor close to VIN to prevent large input voltage spikes.
6	DM1	I	Negative line of the input USB data line pair. DM1 together with DP1 achieves the USB host. DM1 has automatic charging port detection.
7	DP1	I	Positive line of the input USB data line pair. DP1 together with DM1 achieves the USB host. DP1 has automatic charging port detection.
8	TC	O	Torch control output. TC is the open-drain structure. The internal driver MOSFET is on when PB is pulled low for more than 1.5ms twice within one second.
9	ILIM	I	Input current setting. Connect ILIM to GND with an external resistor to program an input current limit in charge mode when a dedicated charger is detected.
10	DM2	O	Negative line of the output USB data line pair. DM2 together with DP2 automatically provides the correct voltage signal for attached portable equipment to perform DCP detection.
11	DP2	O	Positive line of the output USB data line pair. DP2 together with DM2 automatically provides the correct voltage signal for attached portable equipment to perform DCP detection.
12	PB	I	<p>Push button input. Connect a push button from PB to AGND. PB is pulled up by a resistor internally. When PB is set from high to low for more than 1.5ms, the boost is enabled and latched if V_{IN} is not available.</p> <p>LED1-4 are on for five seconds whenever PB is set from high to low for more than 1.5ms.</p> <p>If PB is set from high to low for more than 1.5ms twice within one second and the torch light is off, the torch light drive MOSFET is on and latched. However, if PB is set from high to low for more than 1.5ms twice within one second and the torch drive MOSFET is on, the torch light drive MOSFET is off.</p> <p>If PB is set from high to low for more than 2.5 seconds, this is defined as a long push, and boost is shut down manually.</p>
13	TMR	I	Oscillator period timer. Connect a timing capacitor between TMR and GND to set the oscillator period. Short TMR to GND to disable the timer function.
14	ISET	I	Programmable charge current. Connect an external resistor to GND to program the charge current.
15	OLIM	I	Programmable output current limit for boost mode. Connect an external resistor to GND to program the system current in boost mode.

PIN FUNCTIONS *(continued)*

P/N	Name	I/O	Description
16	VCC	I	Internal circuit power supply. Bypass VCC to GND with a ceramic capacitor no higher than 100nF.
17	AGND	I/O	Analog ground.
18	VNTC	O	Pull-up voltage source for the NTC function. VNTC is connected to VCC through an internal MOSFET. VNTC is disconnected from VCC during sleep mode. VNTC should be the pull-up voltage of the external NTC resistive divider.
19	NTC	I	Negative temperature coefficient (NTC) thermistor.
20	VB	I	Programmable battery full voltage. Leave VB floating for 4.2V. Connect VB to logic high for 4.45V. Connect VB to GND for 4.35V.
21	BATT	I	Positive battery terminal/battery charge current sense negative input.
22	CSP	I	Battery charge current sense positive input.
23	LED4	O	LED4 together with LED1, LED2, and LED3 achieves the voltage-based fuel gauge indication.
24	LED3	O	LED3 together with LED1, LED2, and LED4 achieves the voltage-based fuel gauge indication.
25	LED2	O	LED2 together with LED1, LED3, and LED4 achieves the voltage-based fuel gauge indication.
26	LED1	O	LED1 together with LED2, LED3, and LED4 achieves the voltage-based fuel gauge indication.

BLOCK DIAGRAM

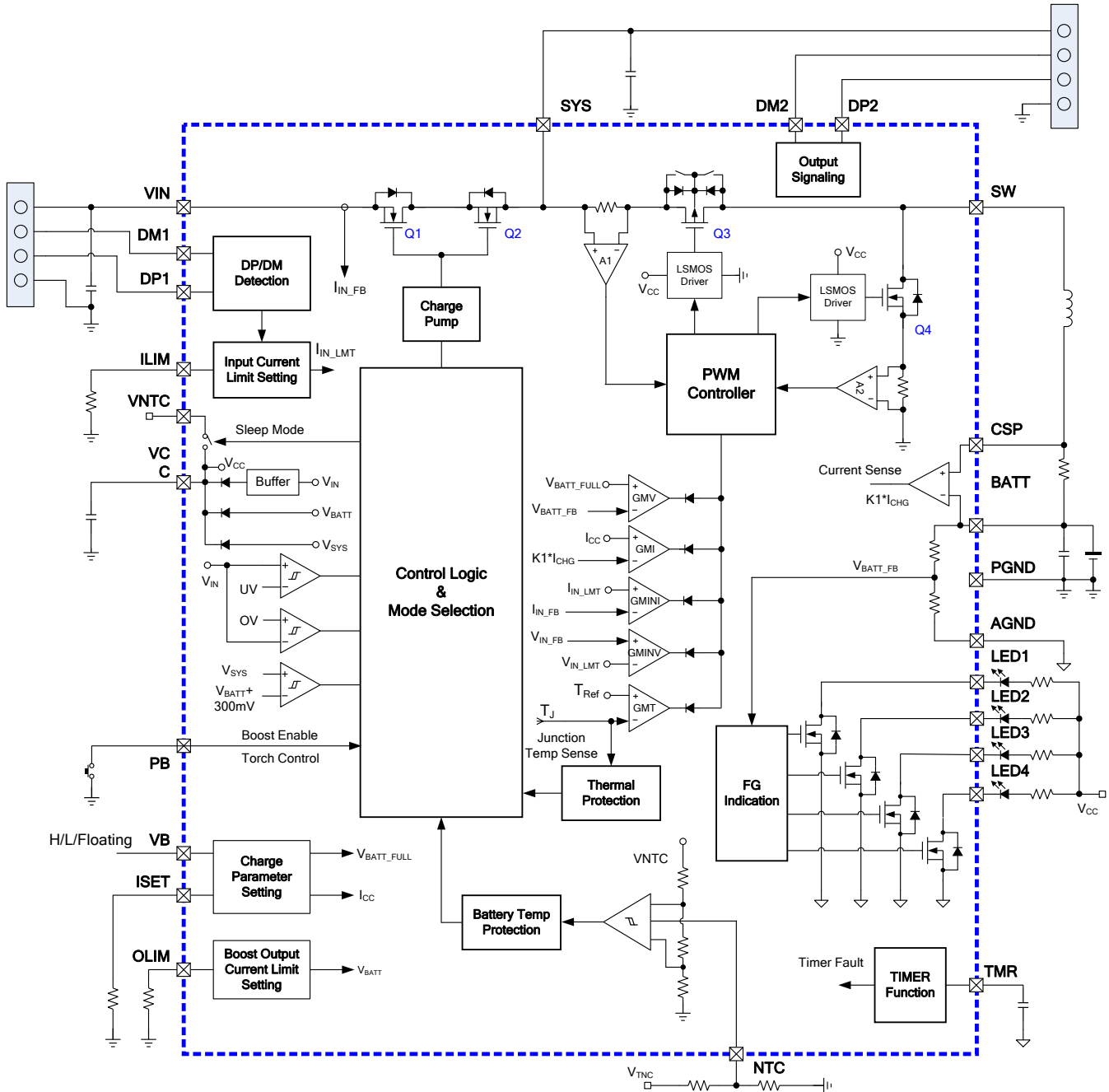

Figure 1: Functional Block Diagram in Charge Mode

BLOCK DIAGRAM (continued)

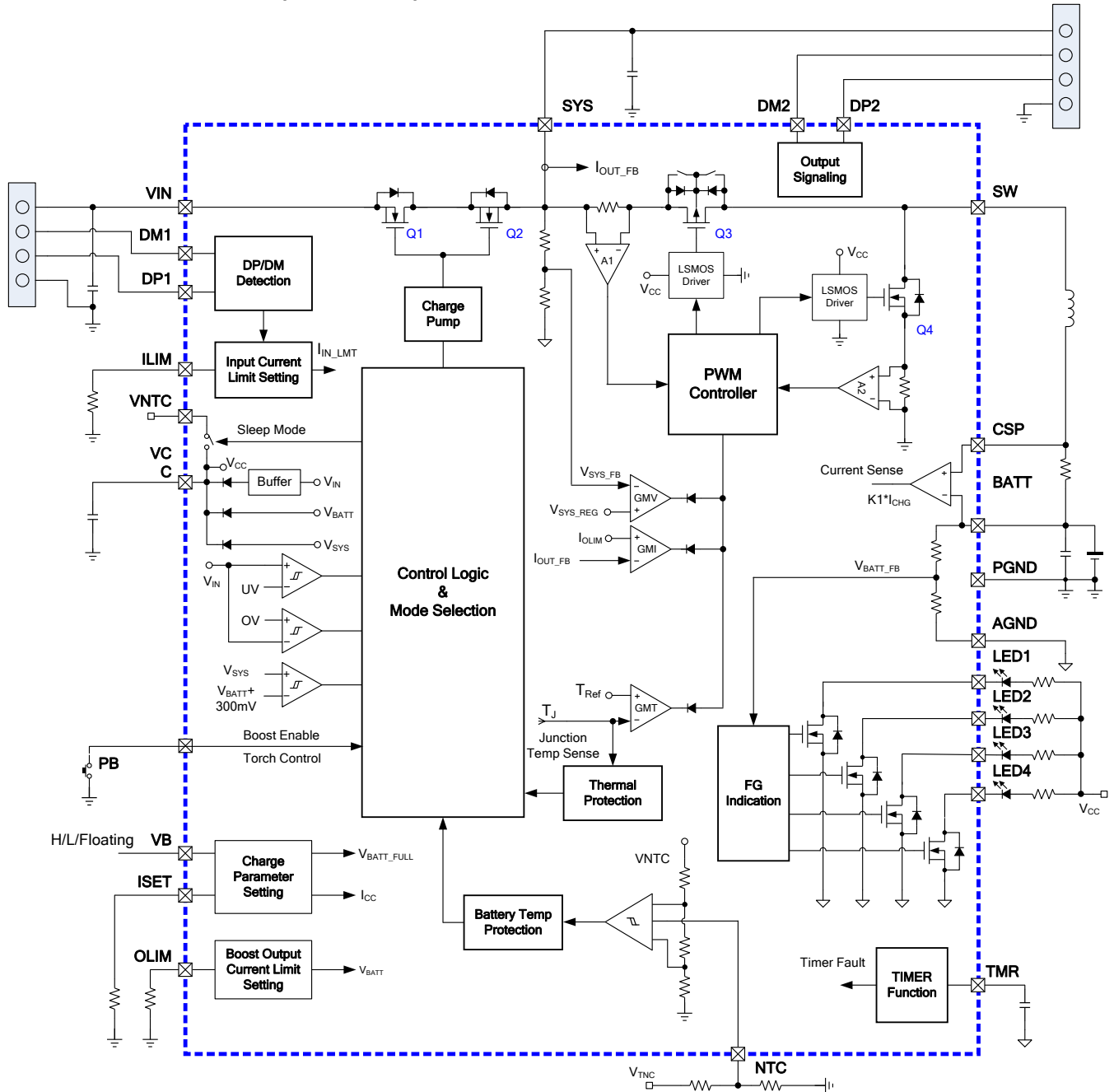

Figure 2: Functional Block Diagram in Boost Mode

OPERATION FLOW CHART

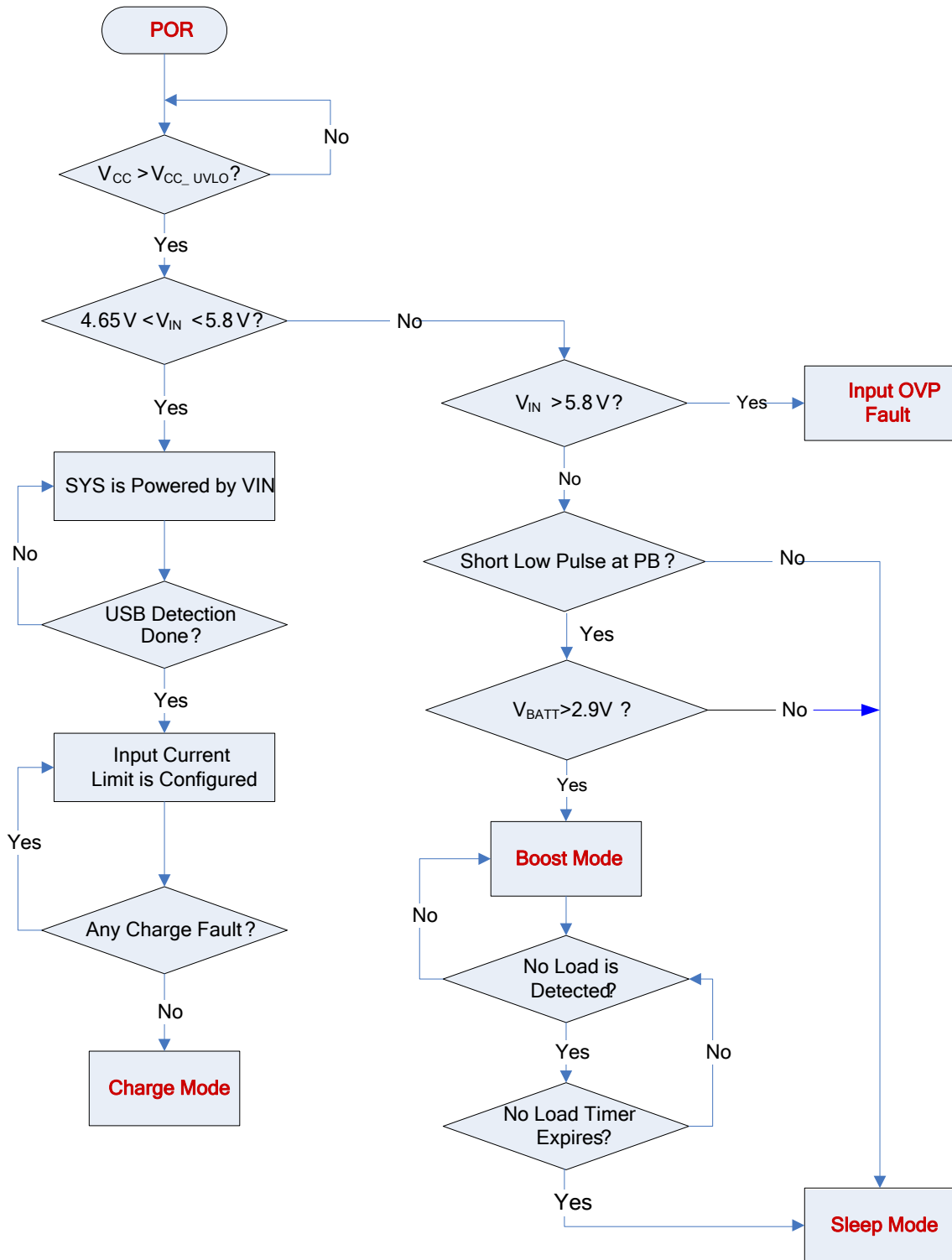

Figure 3: Mode Selection Flow Chart

OPERATION FLOW CHART (continued)

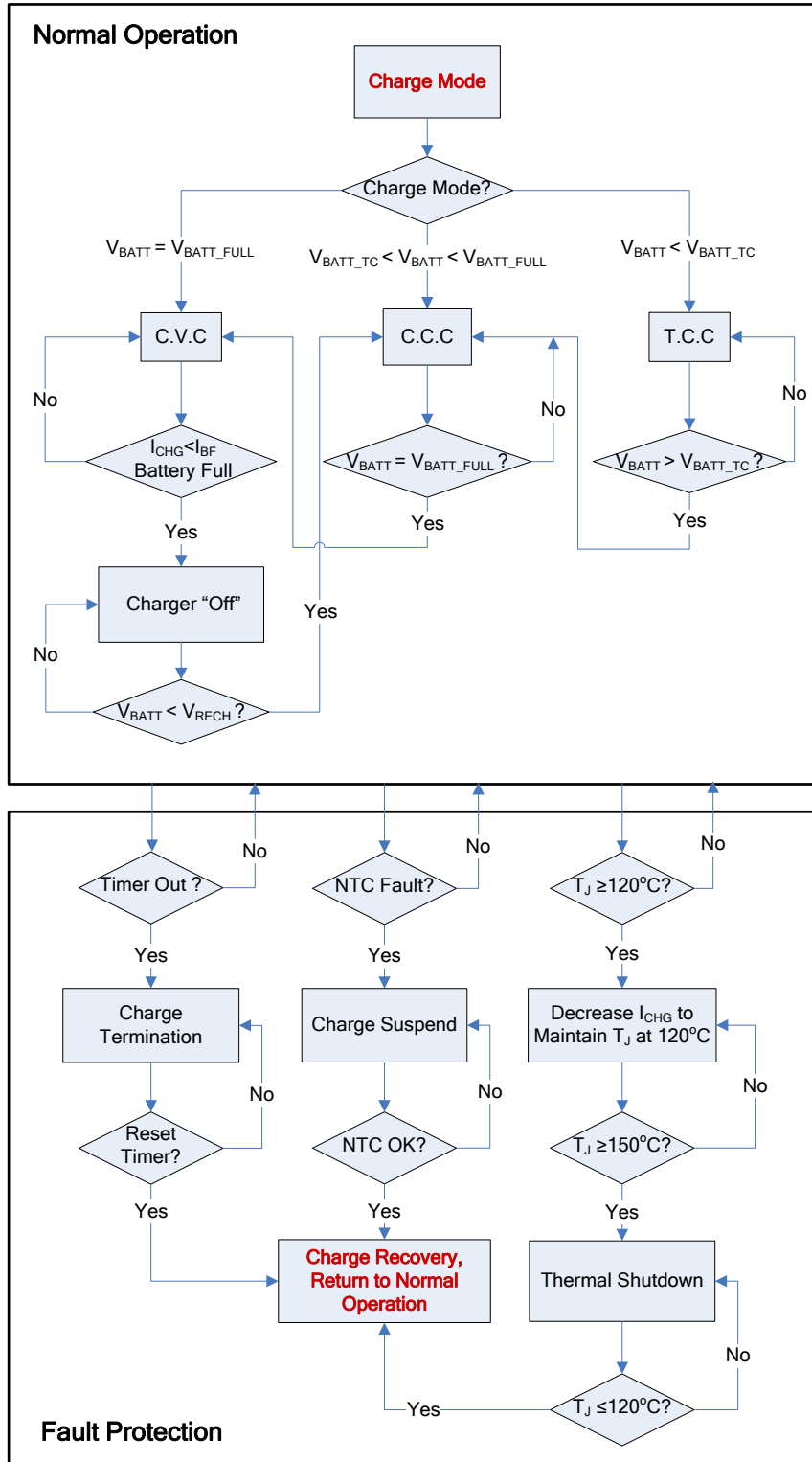

Figure 4: Normal Operation and Fault Protection in Charge Mode

OPERATION FLOW CHART (continued)

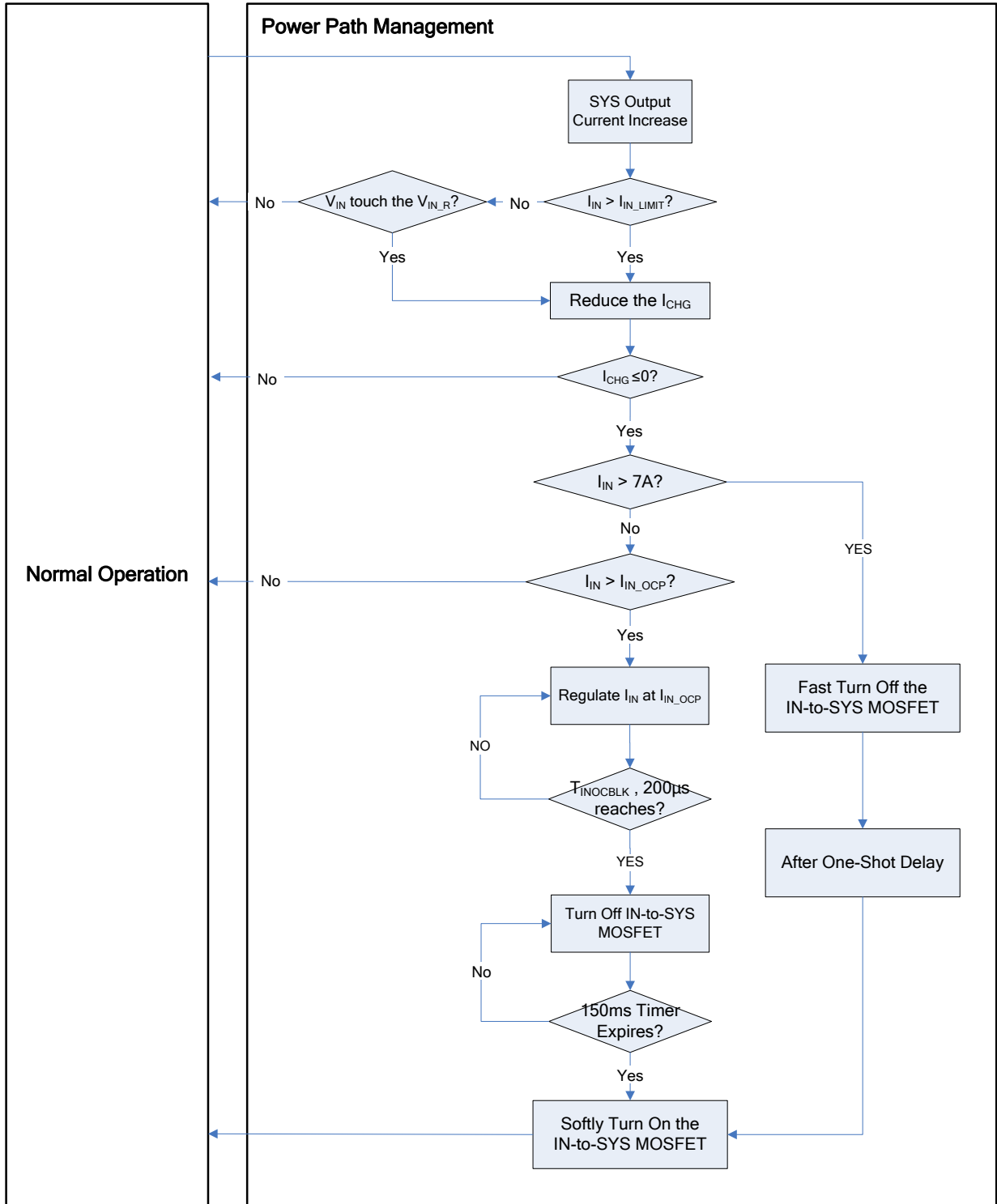

Figure 5: Power-Path Management in Charge Mode

OPERATION FLOW CHART (continued)

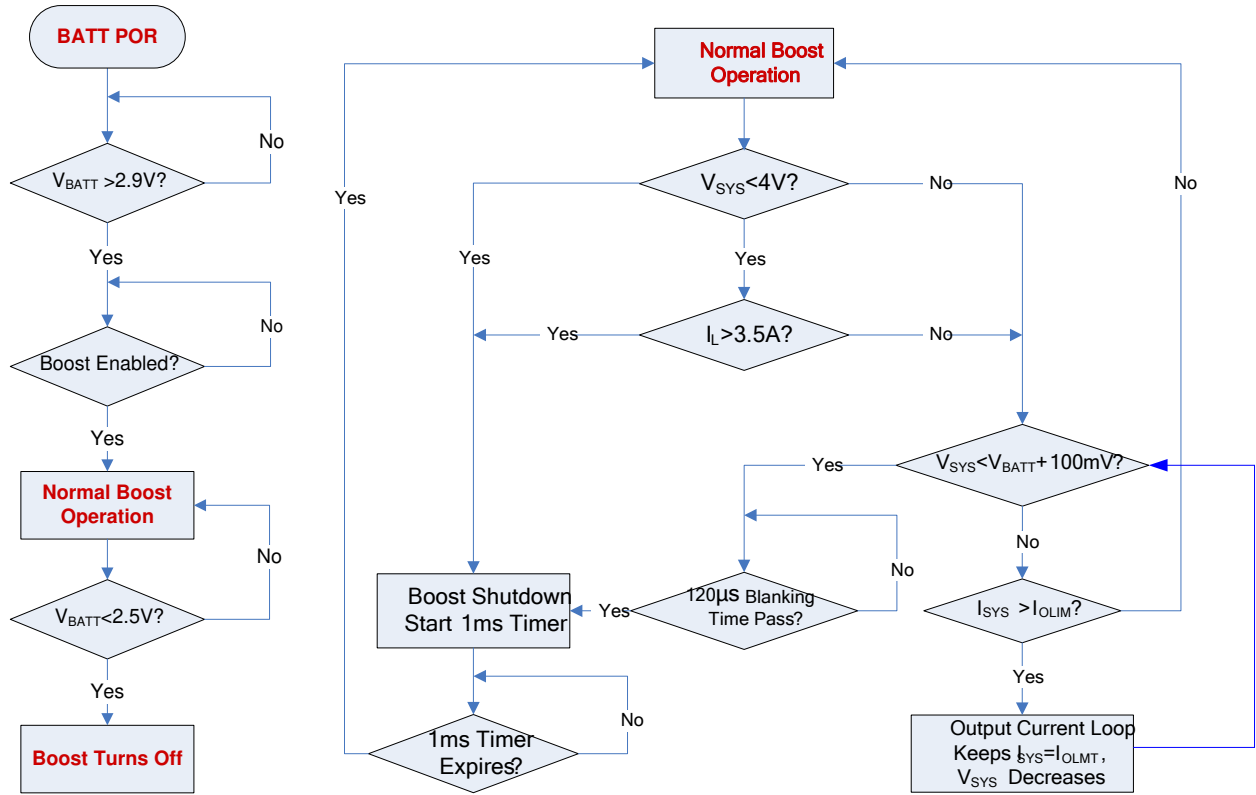

Figure 6: Operation Flow Chart in Boost Mode

START-UP TIME FLOW IN CHARGE MODE

Condition: $V_{IN} = 5V$, $V_{BATT} = 3.8V$

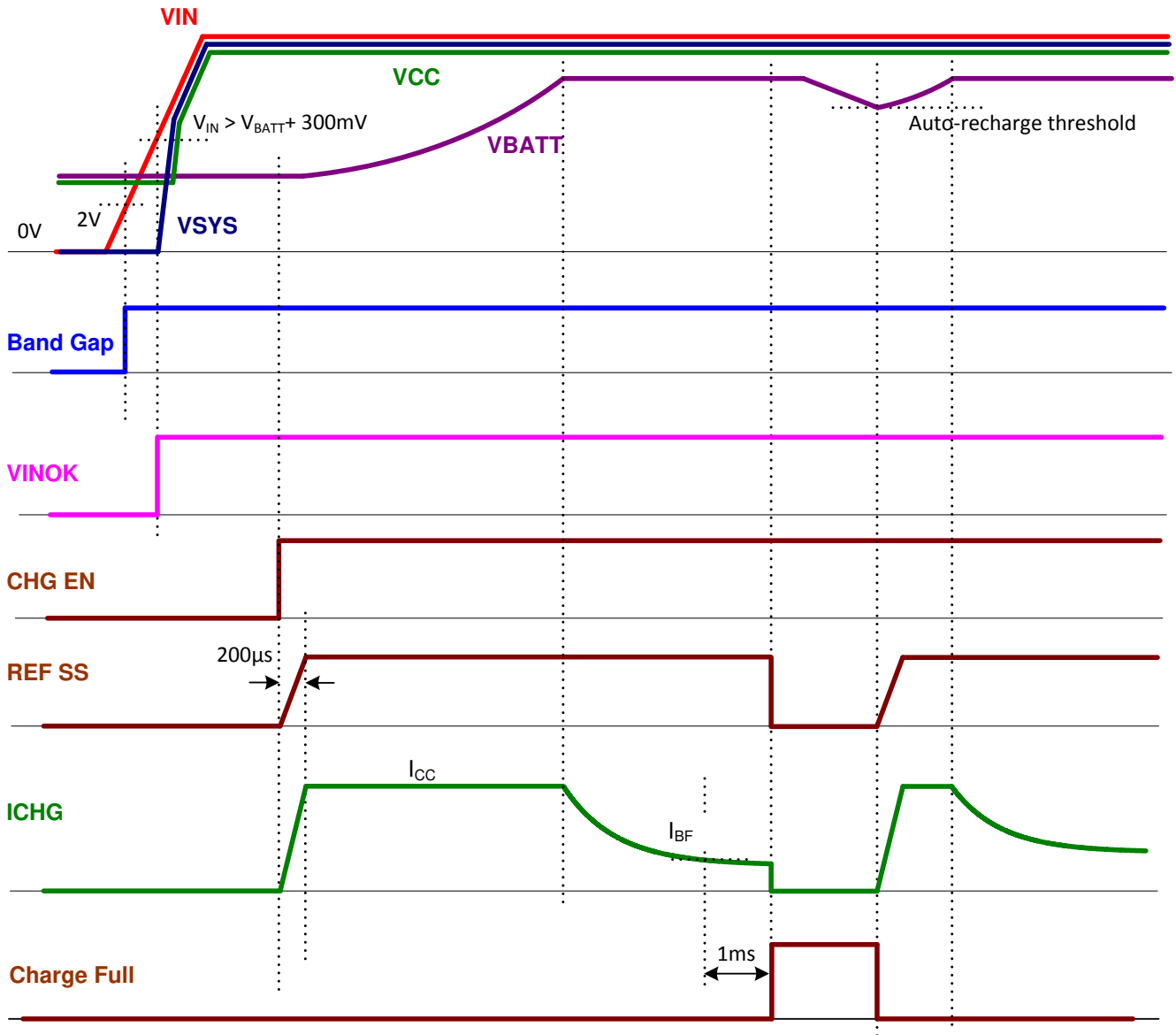

Figure 7: Input Power Start-Up Time Flow in Charge Mode

START-UP TIME FLOW IN BOOST MODE

Condition: $V_{IN} = 0V$, $V_{BATT} = 3.8V$

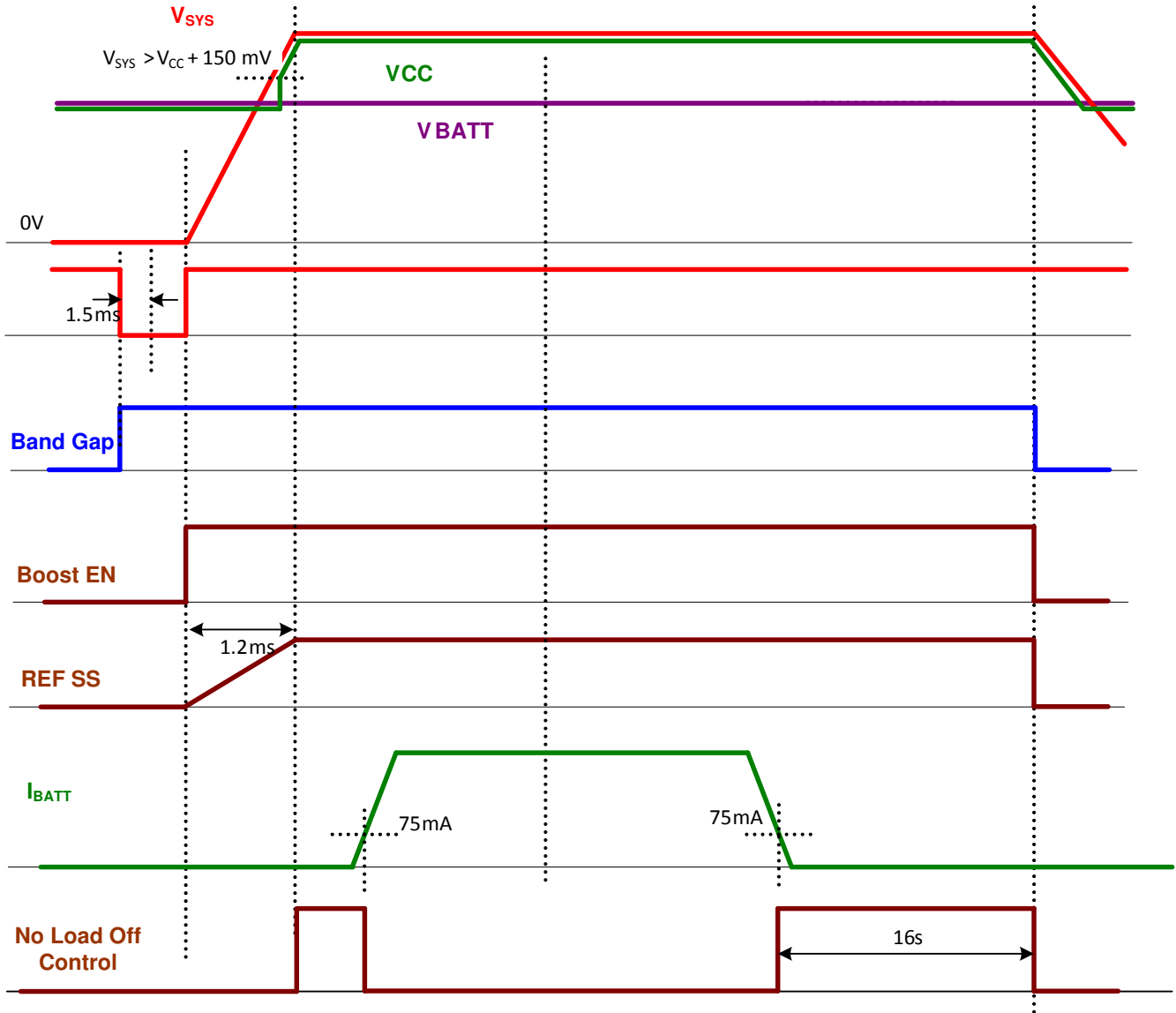

Figure 8: Boost Start-Up Time Flow in Boost Mode

OPERATION

The MP2632 is a highly integrated, flexible, switch-mode battery charger with system power-path management designed for single-cell Li-ion or Li-polymer battery use in a wide range of applications. Depending on the status of the input, the IC can operate in three different modes: charge mode, boost mode, and sleep mode.

In charge mode, the IC can work with a single-cell Li-ion or Li-polymer battery. In boost mode, the IC boosts the battery voltage to V_{SYS} to power higher voltage system rails. In sleep mode, both charging and boost operations are disabled, and the device enters a power saving mode to help reduce overall power consumption. The IC monitors V_{IN} to allow smooth transitions between different modes of operation.

VCC Power Supply

The MP2632 has an external VCC power supply. VCC is powered by the highest voltage level out of V_{SYS} , V_{BATT} , and $V_{IN} - 0.7V$. An external capacitor is required to bypass VCC to GND. When VCC is higher than 2.2V, the internal control circuit is activated.

Charge Mode Operation

Charge Cycle

(Trickle Charge → CC Charge → CV Charge)

In charge mode, the IC uses five control loops to regulate the input current, input voltage, charge current, charge voltage, and device junction temperature. The IC charges the battery in three phases: trickle current (TC), constant current (CC), and constant voltage (CV).

When charge operation is enabled, all five loops are active, but only one dictates the IC behavior. A typical battery charge profile is shown in Figure 9a. The charger stays in TC charge mode until the battery voltage reaches a TC-to-CC threshold. Otherwise, the charger enters CC charge mode.

When the battery voltage rises to the CV mode threshold, the charger operates in constant voltage mode. Figure 9b shows a typical charge profile when the input current limit loop dominates during the CC charge mode. In this case, the charger maximizes the charging current due to the switching-mode charging solution, resulting in charging that is faster than a traditional linear charging solution.

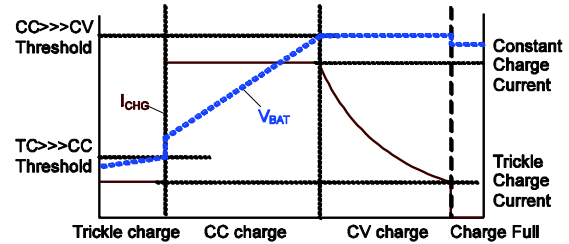

a) Without input current limit

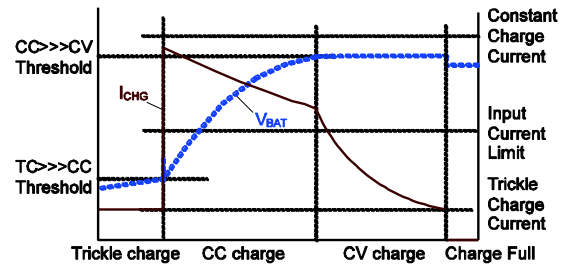

b) With input current limit

Figure 9: Typical Battery Charge Profile

Auto-Recharge

Once the battery charge cycle is completed, the charger remains off. During this time, the system load may consume battery power, or the battery may self-discharge. To ensure that the battery does not go into depletion, a new charge cycle begins automatically when the battery voltage falls below the auto-recharge threshold and the input power is present. The timer resets when the auto-recharge cycle begins.

If the input power restarts during the off-state after the battery is fully charged, the charge cycle starts and the timer resets regardless of what the battery voltage is.

Charge Current Setting

The external sense resistors ($RS1$ and R_{ISET}) program the battery charge current (I_{CHG}). Select R_{ISET} based on $RS1$.

To optimize the transfer efficiency, $RS1$ is recommended to be 10mΩ. The relationship between the R_{ISET} and I_{CHG} is shown in Equation (1):

$$I_{CHG} (A) = \frac{1500}{R_{ISET} (k\Omega) \times RS1 (m\Omega)} \quad (1)$$