



Chipsmall Limited consists of a professional team with an average of over 10 year of expertise in the distribution of electronic components. Based in Hongkong, we have already established firm and mutual-benefit business relationships with customers from,Europe,America and south Asia,supplying obsolete and hard-to-find components to meet their specific needs.

With the principle of “Quality Parts,Customers Priority,Honest Operation,and Considerate Service”,our business mainly focus on the distribution of electronic components. Line cards we deal with include Microchip,ALPS,ROHM,Xilinx,Pulse,ON,Everlight and Freescale. Main products comprise IC,Modules,Potentiometer,IC Socket,Relay,Connector.Our parts cover such applications as commercial,industrial, and automotives areas.

We are looking forward to setting up business relationship with you and hope to provide you with the best service and solution. Let us make a better world for our industry!



Contact us

Tel: +86-755-8981 8866 Fax: +86-755-8427 6832

Email & Skype: info@chipsmall.com Web: www.chipsmall.com

Address: A1208, Overseas Decoration Building, #122 Zhenhua RD., Futian, Shenzhen, China



MOD BLOCK - 2X6 Performance

IP67-Rated Module built with Cree XHP35 LEDs

Primary Applications



High Mast	Canopy
Streetlight	Garage
Stadium	Portable
Architectural	High bay



Features and Benefits

- IP67 Protection – Self-contained module for outdoor applications or other difficult environments
- Optical Flexibility – a variety of off-the-shelf optical patterns are available
- Integrate Further – Easy to add multiple modules through our interlocking technology
- Easy Mounting – designed for quick mounting to a housing or bracket
- Performance – industry leading lumen density and lumens per pound
- Certifications – UL recognized component (E482308) and RoHS compliant
- Custom - private label or design changes available

Introducing the Opulent Americas IP67 rated LED heat sink module using Cree XHP35 Extreme High Power LEDs. This Opulent Americas module is engineered to bring high quality lighting systems to market faster with fewer LEDs, higher reliability, and a lower system cost. This module is a robust, flexible, and versatile building block for any number of lighting systems such as high bay, low bay, parking, and stadium lighting.

Interlocking Technology to Add More Modules

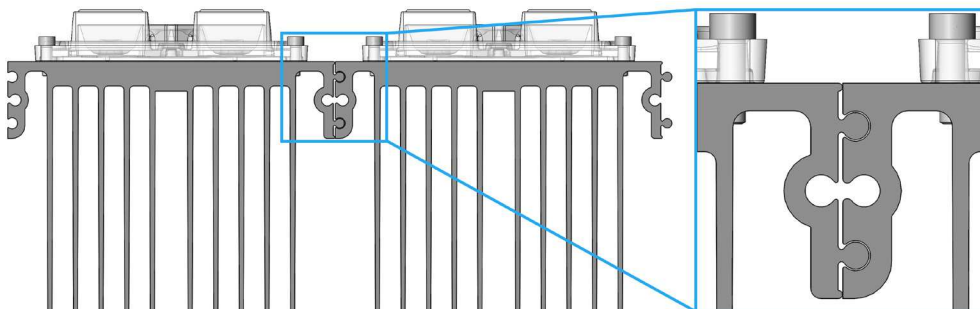

Last Modified: 03/21/17

RoHS 

MOD BLOCK - 2X6 Performance Specifications

Order Code Formatting

Series	-	Color Temperature	Color Rendering Index	-	Optic	-	Cable Type	-	Internal Code
MP26T1 -C19 - XHP35 Mod Block		27 - 2700K	70 - 70 CRI		RS		1 - Cable Pigtail		XX
		30 - 3000K	80 - 80 CRI		M		2 - Waterproof M15 Cable		
		40 - 4000K	90 - 90 CRI		W				
		50 - 5000K			WWW				
		57 - 5700K			O				
					T2				
					T2B				
					T3				
					T3B				
					T4B				
					VSM				
					DWC				
					ME				
					SCL				

*See Page 5 for Photometric Distributions

MOD BLOCK - 2X6 Performance Specifications

Ordering Information

Part Number	CCT	CRI	Binning	Forward Voltage (V)	Current (mA)	Luminous Flux (lm)	Efficacy Nominal (lm/W)	Watts (W)
MP26T1-C19-5770-x	5700K	70	5-Step	46.1	1050	7512	155	48.4
	5700K	70	5-Step	46.7	1500	9856	140	70.0
	5700K	70	5-Step	47.2	2100	12286	124	99.2
MP26T1-C19-5070-x	5000K	70	5-Step	46.1	1050	7512	155	48.4
	5000K	70	5-Step	46.7	1500	9856	140	70.0
	5000K	70	5-Step	47.2	2100	12286	124	99.2
MP26T1-C19-4070-x	4000K	70	5-Step	46.1	1050	6980	144	48.4
	4000K	70	5-Step	46.7	1500	9158	130	70.0
	4000K	70	5-Step	47.2	2100	11416	115	99.2

*Product performance based on 25°C ambient temperature

Ratings

Parameter	Unit	Rating
Solder Point Temperature	Degrees	105
Operating Temperature	degrees	-40 to +50
Weight	G	1332

MOD BLOCK - 2X6 Performance Specifications

Spatial Distribution

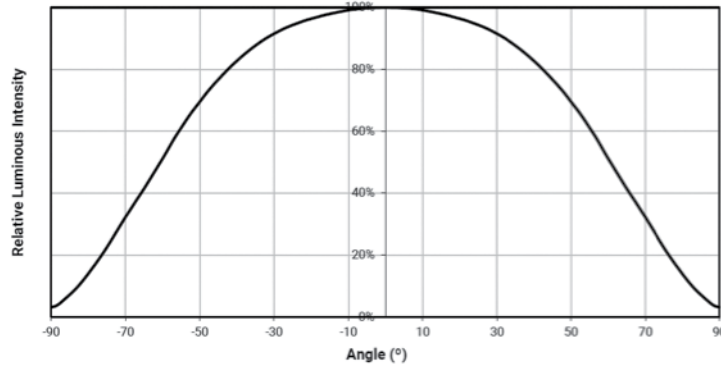

Performance Groups – Chromaticity

5-Step Binning					
CCT	Center Point		Major Axis	Minor Axis	Rotation Angle (°)
	X	Y	a	b	
5700K	0.3287	0.3417	0.01230	0.00600	72.0
5000K	0.3447	0.3553	0.01400	0.00520	65.0
4000K	0.3818	0.3797	0.001420	0.00550	61.5

MOD BLOCK - 2X6 Performance Specifications

Photometric Distributions - High Bay Series

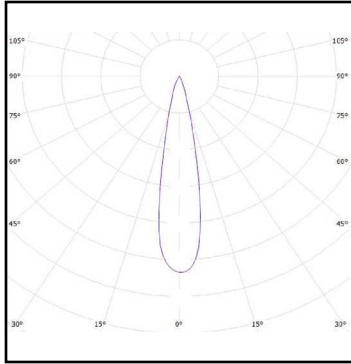

CS14895_HB-IP-2X6-RS

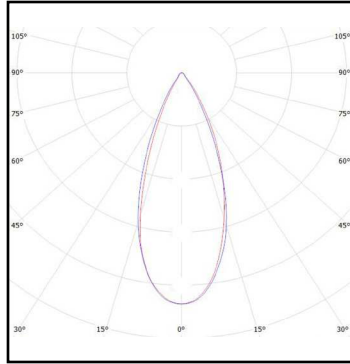

CS14891_HB-IP-2X6-M

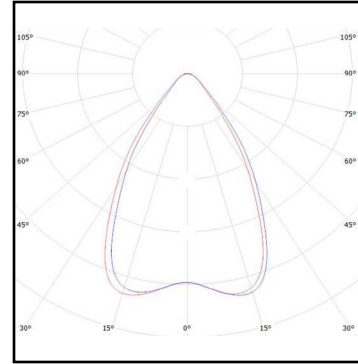

CS14130_HB-IP-2X6-W

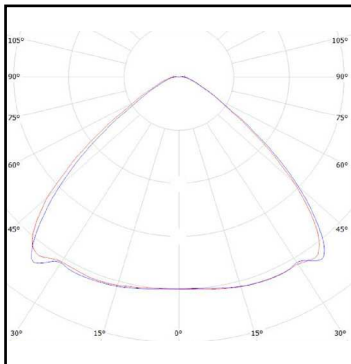

CS14263_HB-IP-2X6-WWW

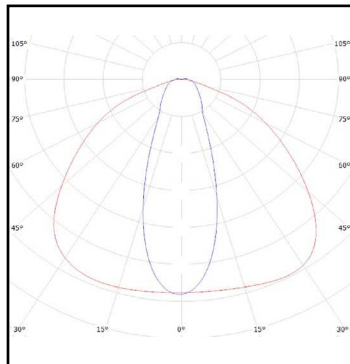

CS14597_HB-IP-2X6-O

MOD BLOCK - 2X6 Performance Specifications

Photometric Distributions - Strada IP Series

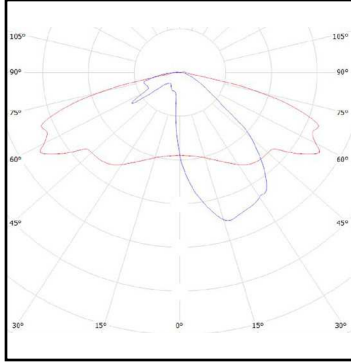

CS14055_STRADA-IP-2X6-T2

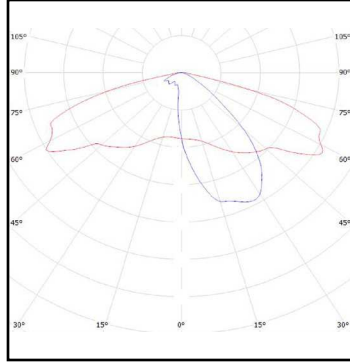

CS15363_STRADA-IP-2X6-T2-B

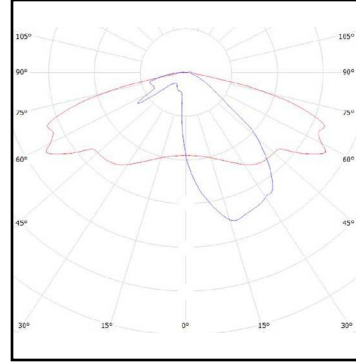

CS14143_STRADA-IP-2X6-T3

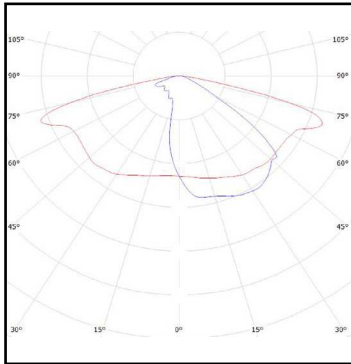

CS15362_STRADA-IP-2X6-T3-B

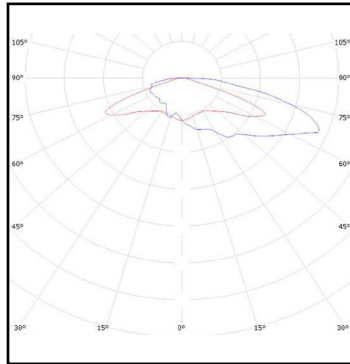

CS15158_STRADA-IP-2X6-T4-B

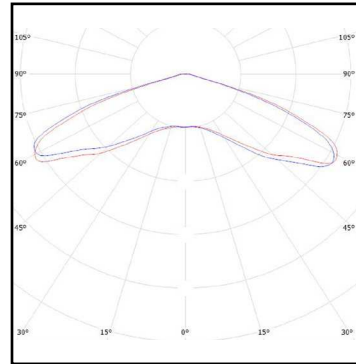

CS15020_STRADA-IP-2X6-VSM

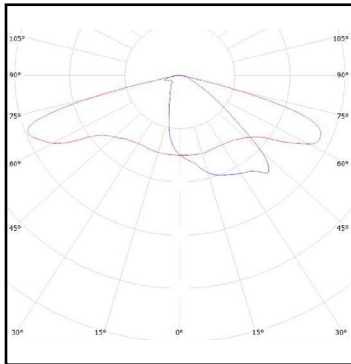

CS12862_STRADA-IP-2X6-DWC

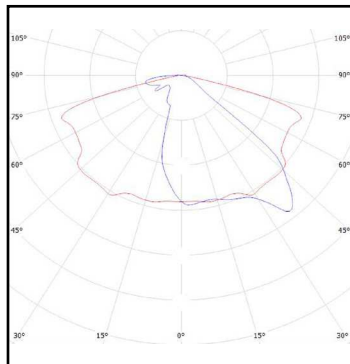

CS14144_STRADA-IP-2X6-ME

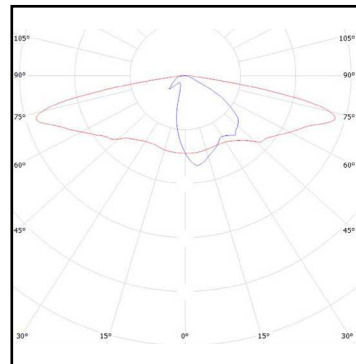

CS15418_STRADA-IP-2X6-SCL

MOD BLOCK - 2X6 Performance Specifications

Mechanical Dimensions

