



Chipsmall Limited consists of a professional team with an average of over 10 year of expertise in the distribution of electronic components. Based in Hongkong, we have already established firm and mutual-benefit business relationships with customers from,Europe,America and south Asia,supplying obsolete and hard-to-find components to meet their specific needs.

With the principle of “Quality Parts,Customers Priority,Honest Operation,and Considerate Service”,our business mainly focus on the distribution of electronic components. Line cards we deal with include Microchip,ALPS,ROHM,Xilinx,Pulse,ON,Everlight and Freescale. Main products comprise IC,Modules,Potentiometer,IC Socket,Relay,Connector.Our parts cover such applications as commercial,industrial, and automotives areas.

We are looking forward to setting up business relationship with you and hope to provide you with the best service and solution. Let us make a better world for our industry!



## Contact us

Tel: +86-755-8981 8866 Fax: +86-755-8427 6832

Email & Skype: info@chipsmall.com Web: www.chipsmall.com

Address: A1208, Overseas Decoration Building, #122 Zhenhua RD., Futian, Shenzhen, China



## MEMS audio sensor omnidirectional digital microphone

Datasheet - production data

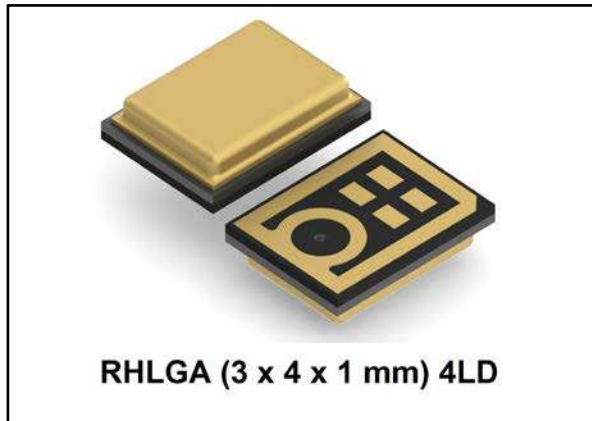

- Speech recognition
- A/V eLearning devices
- Gaming and virtual reality input devices
- Digital still and video cameras
- Antitheft systems

### Description

The MP34DB02 is an ultra-compact, low-power, omnidirectional, digital MEMS microphone built with a capacitive sensing element and an IC interface with stereo operation capability.

The sensing element, capable of detecting acoustic waves, is manufactured using a specialized silicon micromachining process dedicated to produce audio sensors.

The IC interface is manufactured using a CMOS process that allows designing a dedicated circuit able to provide a digital signal externally in PDM format.

The MP34DB02 has an acoustic overload point of 120 dB SPL with a best-on-the-market 62.6 dB signal-to-noise ratio and -26 dBFS sensitivity.

The MP34DB02 is available in a bottom-port, SMD-compliant, EMI-shielded package and is guaranteed to operate over an extended temperature range from -40 °C to +85 °C.

### Features

- Single supply voltage
- Low power consumption
- 120 dB SPL acoustic overload point
- 62.6 dB signal-to-noise ratio
- Omnidirectional sensitivity
- -26 dBFS sensitivity
- PDM single-bit output with option for stereo configuration
- RHLGA package
  - Bottom-port design
  - SMD-compliant
  - EMI-shielded
  - ECOPACK®, RoHS and “Green” compliant

### Applications

- Mobile terminals
- Laptop and notebook computers
- Portable media players
- VoIP

**Table 1: Device summary**

Part number	Temp. range [°C]	Package	Packing
MP34DB02TR	-40 to +85	RHLGA 4 LD (3x4x1) mm	Tape and reel

---

## Contents

<b>1</b>	<b>Pin description .....</b>	<b>5</b>
<b>2</b>	<b>Acoustic and electrical specifications .....</b>	<b>6</b>
	2.1 Acoustic and electrical characteristics.....	6
	2.2 Timing characteristics .....	7
	2.3 Frequency response .....	8
<b>3</b>	<b>Sensing element.....</b>	<b>9</b>
<b>4</b>	<b>Absolute maximum ratings.....</b>	<b>10</b>
<b>5</b>	<b>Functionality.....</b>	<b>11</b>
	5.1 L/R channel selection.....	11
<b>6</b>	<b>Application recommendations .....</b>	<b>12</b>
<b>7</b>	<b>Package information .....</b>	<b>13</b>
	7.1 Soldering information .....	13
	7.2 RHLGA package information.....	14
<b>8</b>	<b>Revision history .....</b>	<b>16</b>

---

## List of tables

Table 1: Device summary .....	1
Table 2: Pin description .....	5
Table 3: Acoustic and electrical characteristics .....	6
Table 4: Distortion specifications .....	6
Table 5: Timing characteristics .....	7
Table 6: Absolute maximum ratings .....	10
Table 7: L/R channel selection .....	11
Table 8: Recommended soldering profile limits.....	13
Table 9: RHLGA 4LD 3x4 mm (metal cap) 0.25 mm port hole package mechanical data.....	14
Table 10: Document revision history .....	16

---

## List of figures

Figure 1: Pin connections .....	5
Figure 2: Timing waveforms .....	7
Figure 3: Frequency response .....	8
Figure 4: MP34DB02 electrical connections.....	12
Figure 5: MP34DB02 electrical connections for stereo configuration.....	12
Figure 6: Recommended soldering profile limits .....	13
Figure 7: RHLGA 4LD 3x4 mm (metal cap) 0.25 mm port hole package outline .....	14



# 1 Pin description

Figure 1: Pin connections

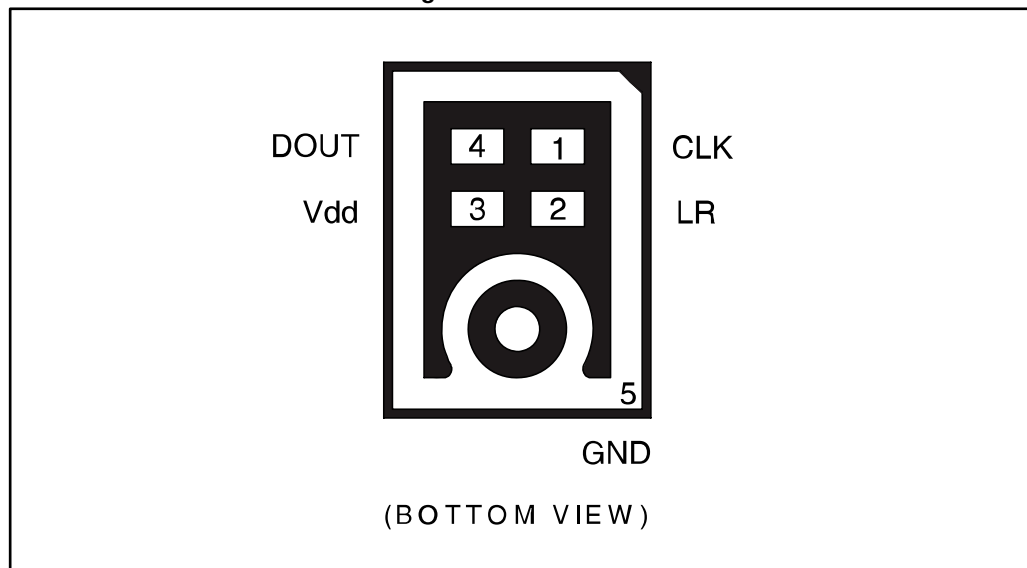

Table 2: Pin description

Pin number	Pin name	Function
1	CLK	Synchronization input clock
2	LR	Left/right channel selection
3	Vdd	Power supply
4	DOUT	Left/right PDM data output
5 (ground ring)	GND	0 V supply

## 2 Acoustic and electrical specifications

### 2.1 Acoustic and electrical characteristics

The values listed in the table below are specified for Vdd = 1.8 V, Clock = 2.4 MHz, T = 25 °C, unless otherwise noted.

**Table 3: Acoustic and electrical characteristics**

Sym.	Parameter	Test condition	Min.	Typ. <sup>(1)</sup>	Max.	Unit
Vdd	Supply voltage		1.64	1.8	3.6	V
Idd	Current consumption in normal mode	Mean value <sup>(2)</sup>		0.65		mA
IddPdn	Current consumption in power-down mode <sup>(3)</sup>			20		μA
Sc	Short-circuit current		1		10	mA
AOP	Acoustic overload point			120		dB SPL
So	Sensitivity	at 1 kHz, 1 Pa	-29	-26	-23	dB FS
SNR	Signal-to-noise ratio	A-weighted at 1 kHz, 1 Pa		62.6		dB
PSR	Power supply rejection	100 mVpp square wave @ 217 Hz, A-weighted		-86		dB FS
Clock	Input clock frequency <sup>(4)</sup>		1	2.4	3.25	MHz
TWK	Wake-up time <sup>(5)</sup>	guaranteed by design			10	ms
Top	Operating temperature range		-40		+85	°C

**Notes:**

<sup>(1)</sup>Typical specifications are not guaranteed.

<sup>(2)</sup>No load on DOUT line.

<sup>(3)</sup>Input clock in static mode.

<sup>(4)</sup>Duty cycle: min = 40% max = 60%

<sup>(5)</sup>Time from the first clock edge to valid output data.

**Table 4: Distortion specifications**

Parameter	Test condition	Value
Distortion	100 dB SPL (50 Hz - 4 kHz)	< 1% THD + N
Distortion	115 dB SPL (1 kHz)	< 5% THD + N

## 2.2 Timing characteristics

Table 5: Timing characteristics

Parameter	Description	Min	Max	Unit
$f_{CLK}$	Clock frequency for normal mode	1	3.25	MHz
$f_{PD}$	Clock frequency for power-down mode		0.23	MHz
$T_{CLK}$	Clock period for normal mode	308	1000	ns
$T_{R,EN}$	Data enabled on DATA line, L/R pin = 1	18 <sup>(1)</sup>	30 <sup>(1)</sup>	ns
$T_{R,DIS}$	Data disabled on DATA line, L/R pin = 1		16 <sup>(1)</sup>	ns
$T_{L,EN}$	Data enabled on DATA line, L/R pin = 0	18 <sup>(1)</sup>	30 <sup>(1)</sup>	ns
$T_{L,DIS}$	Data disabled on DATA line, L/R pin = 0		16 <sup>(1)</sup>	ns

**Notes:**

<sup>(1)</sup>From design simulations

Figure 2: Timing waveforms

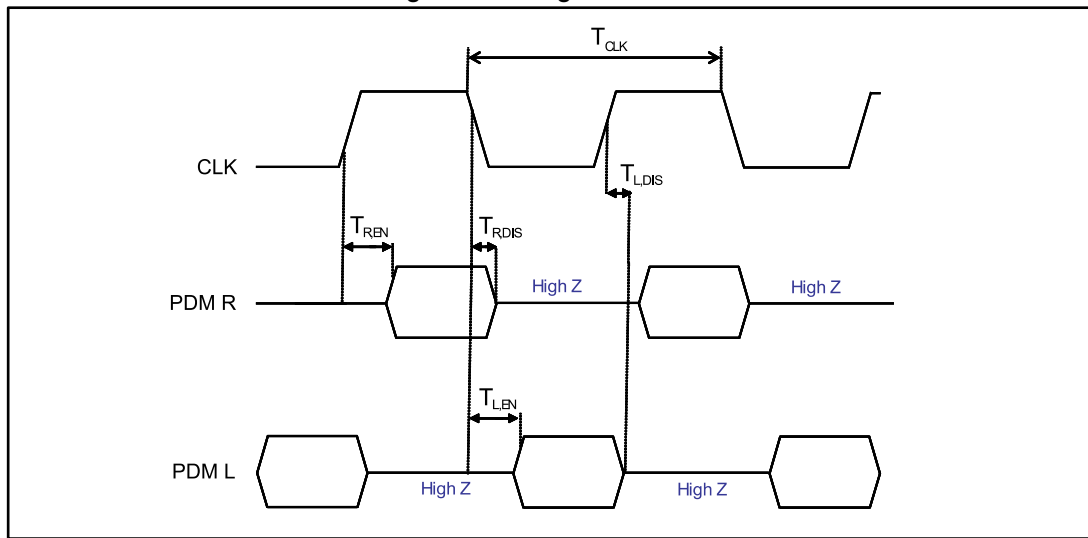



## 2.3 Frequency response

Figure 3: Frequency response

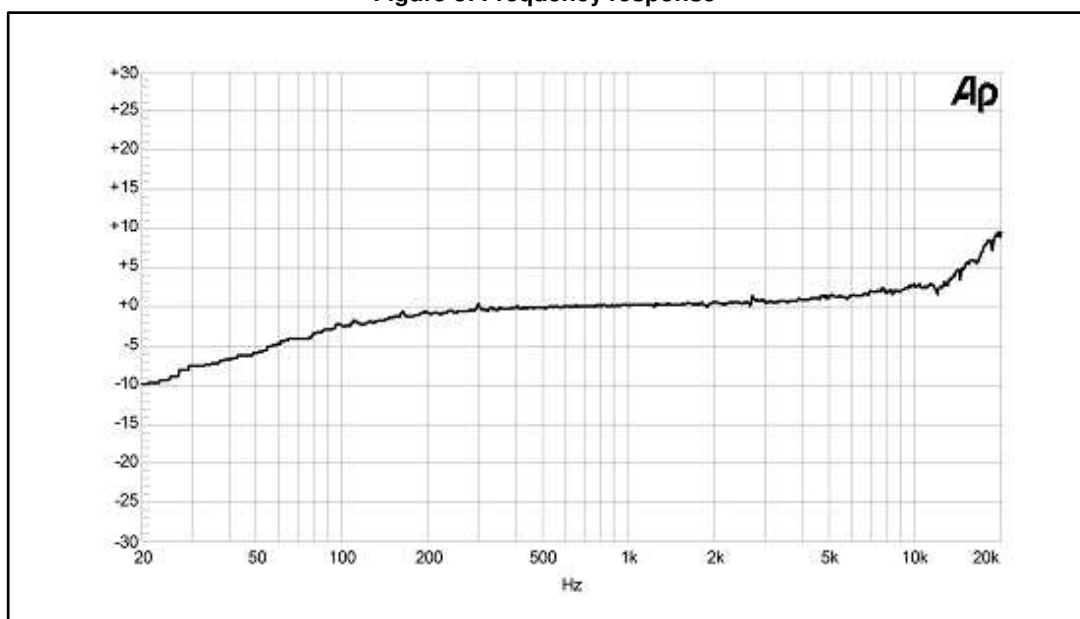

### 3 Sensing element

The sensing element shall mean the acoustic sensor consisting of a conductive movable plate and a fixed plate placed in a tiny silicon chip. This sensor transduces the sound pressure into the changes of coupled capacity between those two plates.

Omron Corporation supplies this element for STMicroelectronics.

## 4 Absolute maximum ratings

Stresses above those listed as “absolute maximum ratings” may cause permanent damage to the device. This is a stress rating only and functional operation of the device under these conditions is not implied. Exposure to maximum rating conditions for extended periods may affect device reliability.

**Table 6: Absolute maximum ratings**

Symbol	Ratings	Maximum value	Unit
Vdd	Supply voltage	-0.3 to 6	V
Vin	Input voltage on any control pin	-0.3 to Vdd +0.3	V
T <sub>STG</sub>	Storage temperature range	-40 to +125	°C
ESD	Electrostatic discharge protection	2 (HBM)	kV



This device is sensitive to mechanical shock, improper handling can cause permanent damage to the part.



This device is sensitive to electrostatic discharge (ESD), improper handling can cause permanent damage to the part.

## 5 Functionality

### 5.1 L/R channel selection

The L/R digital pad lets the user select the DOUT signal pattern as explained in [Table 7: "L/R channel selection"](#). The L/R pin must be connected to Vdd or GND.

**Table 7: L/R channel selection**

L/R	CLK low	CLK high
GND	Data valid	High impedance
Vdd	High impedance	Data valid

## 6 Application recommendations

Figure 4: MP34DB02 electrical connections

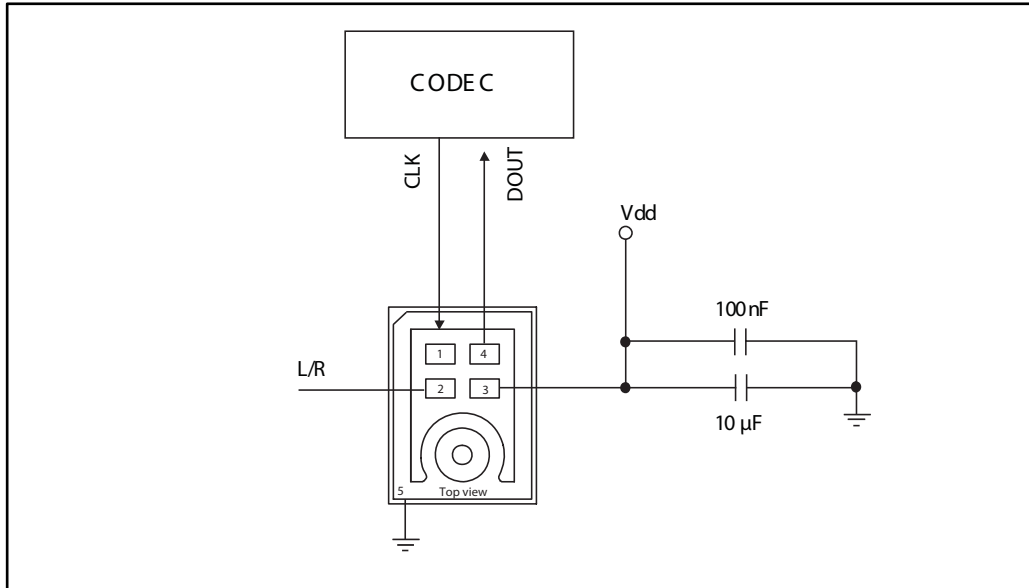
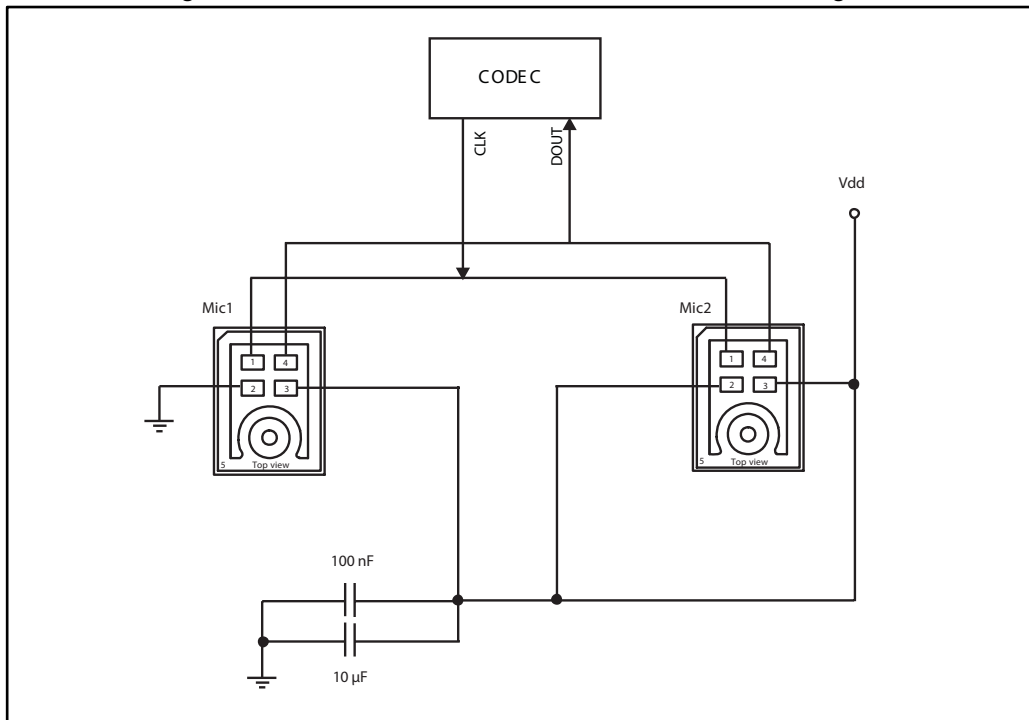

Figure 5: MP34DB02 electrical connections for stereo configuration



Power supply decoupling capacitors (100 nF ceramic, 10 µF ceramic) should be placed as near as possible to pin 3 of the device (common design practice).

The L/R pin must be connected to Vdd or GND (refer to [Table 7: "L/R channel selection"](#)).

## 7 Package information

In order to meet environmental requirements, ST offers these devices in different grades of ECOPACK<sup>®</sup> packages, depending on their level of environmental compliance. ECOPACK<sup>®</sup> specifications, grade definitions and product status are available at: [www.st.com](http://www.st.com). ECOPACK<sup>®</sup> is an ST trademark.

### 7.1 Soldering information

The RHLGA (3 x 4 x 1) mm package is also compliant with the RoHS and “Green” standards and is qualified for soldering heat resistance according to JEDEC J-STD-020.

Landing pattern and soldering recommendations are available at [www.st.com](http://www.st.com).

Figure 6: Recommended soldering profile limits

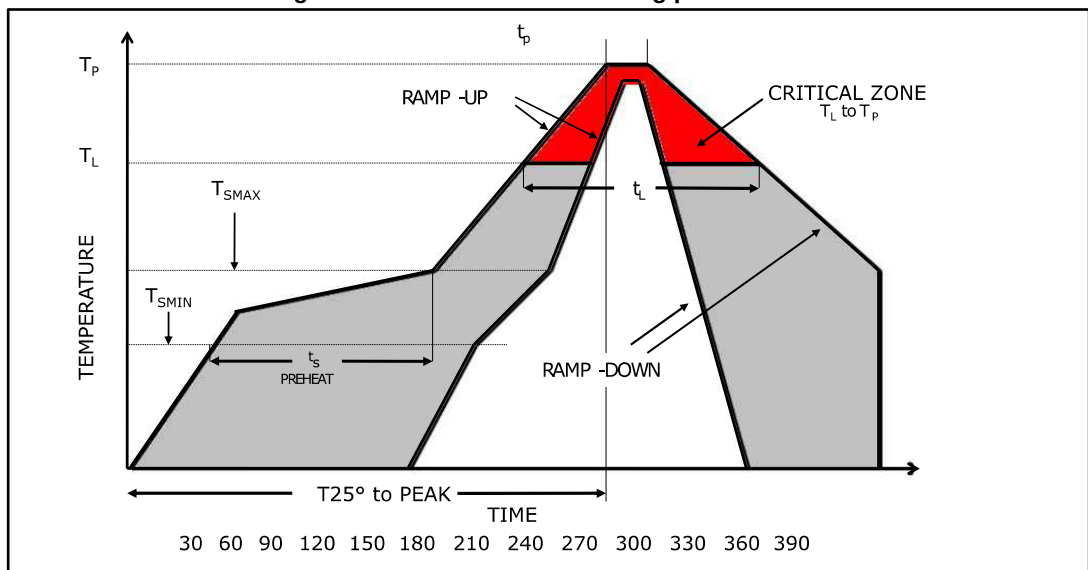

Table 8: Recommended soldering profile limits

Desription	Parameter	Pb free
Average ramp rate	$T_L$ to $T_P$	3 °C/sec max
Preheat	$T_{SMIN}$	150 °C
Minimum temperature	$T_{SMAX}$	200 °C
Maximum temperature	$t_s$	60 sec to 120 sec
Time ( $T_{SMIN}$ to $T_{SMAX}$ )		
Ramp-up rate	$T_{SMAX}$ to $T_L$	
Time maintained above liquidus temperature	$t_L$	60 sec to 150 sec
Liquidus temperature	$T_L$	217 °C
Peak temperature	$T_P$	260 °C max
Time within 5 °C of actual peak temperature		20 sec to 40 sec
Ramp-down rate		6 °C/sec max
Time 25 °C ( $t_{25}$ °C) to peak temperature		8 minutes max

## 7.2 RHLGA package information

Figure 7: RHLGA 4LD 3x4 mm (metal cap) 0.25 mm port hole package outline

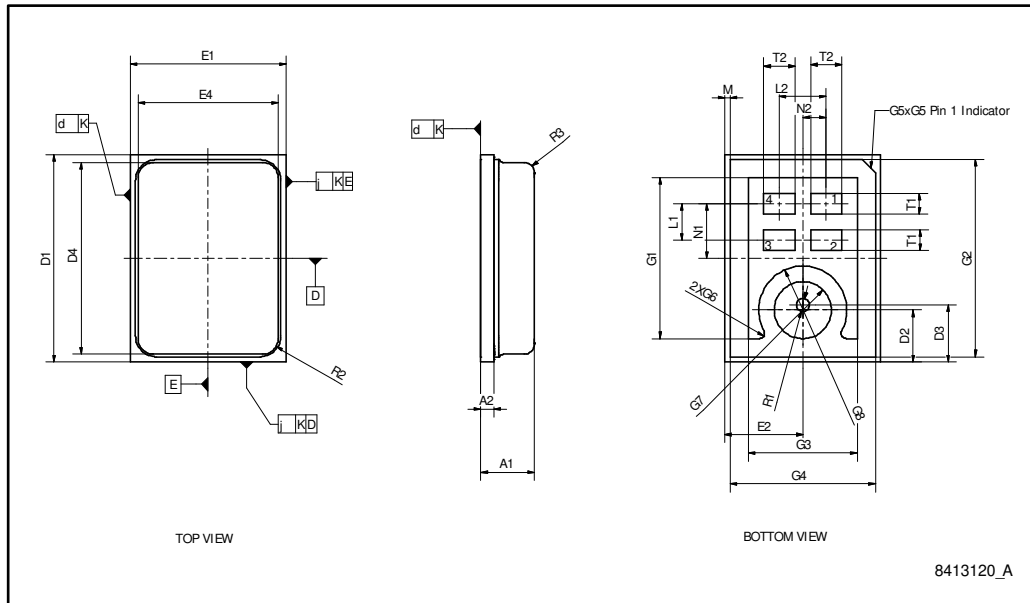

Table 9: RHLGA 4LD 3x4 mm (metal cap) 0.25 mm port hole package mechanical data

Symbol	mm.		
	Min.	Typ.	Max.
A1	0.900	1.000	1.100
A2	0.200	0.250	0.300
D1	3.900	4.000	4.100
D2	0.900	1.000	1.100
D3	1.000	1.100	1.200
D4	3.610	3.700	3.790
R1	0.200	0.250	0.300
R2		0.280	
R3		0.250	
E1	2.900	3.000	3.100
E2	1.300	1.500	1.700
E4	2.610	2.700	2.790
L1	0.650	0.700	0.750
L2	0.850	0.900	0.950
N1	1.000	1.050	1.100
N2	0.400	0.450	0.500
T1	0.350	0.400	0.450
T2	0.550	0.600	0.650
G1	3.050	3.100	3.150
G2	3.750	3.800	3.850
G3	2.050	2.100	2.150



Symbol	mm.		
	Min.	Typ.	Max.
G4	2.750	2.800	2.850
G5	0.250	0.300	0.350
G6	0.050	0.100	0.150
G7	0.500	0.550	0.600
G8	0.800	0.850	0.900
M		0.100	
K		0.050	

## 8 Revision history

Table 10: Document revision history

Date	Revision	Changes
21-Mar-2014	1	Initial release
28-Apr-2016	2	Updated <i>Table 1: "Device summary"</i> Updated PSR in <i>Table 3: "Acoustic and electrical characteristics"</i>

**IMPORTANT NOTICE – PLEASE READ CAREFULLY**

STMicroelectronics NV and its subsidiaries ("ST") reserve the right to make changes, corrections, enhancements, modifications, and improvements to ST products and/or to this document at any time without notice. Purchasers should obtain the latest relevant information on ST products before placing orders. ST products are sold pursuant to ST's terms and conditions of sale in place at the time of order acknowledgement.

Purchasers are solely responsible for the choice, selection, and use of ST products and ST assumes no liability for application assistance or the design of Purchasers' products.

No license, express or implied, to any intellectual property right is granted by ST herein.

Resale of ST products with provisions different from the information set forth herein shall void any warranty granted by ST for such product.

ST and the ST logo are trademarks of ST. All other product or service names are the property of their respective owners.

Information in this document supersedes and replaces information previously supplied in any prior versions of this document.

© 2016 STMicroelectronics – All rights reserved