



Chipsmall Limited consists of a professional team with an average of over 10 year of expertise in the distribution of electronic components. Based in Hongkong, we have already established firm and mutual-benefit business relationships with customers from,Europe,America and south Asia,supplying obsolete and hard-to-find components to meet their specific needs.

With the principle of “Quality Parts,Customers Priority,Honest Operation,and Considerate Service”,our business mainly focus on the distribution of electronic components. Line cards we deal with include Microchip,ALPS,ROHM,Xilinx,Pulse,ON,Everlight and Freescale. Main products comprise IC,Modules,Potentiometer,IC Socket,Relay,Connector.Our parts cover such applications as commercial,industrial, and automotives areas.

We are looking forward to setting up business relationship with you and hope to provide you with the best service and solution. Let us make a better world for our industry!



Contact us

Tel: +86-755-8981 8866 Fax: +86-755-8427 6832

Email & Skype: info@chipsmall.com Web: www.chipsmall.com

Address: A1208, Overseas Decoration Building, #122 Zhenhua RD., Futian, Shenzhen, China



DESCRIPTION

The MP4032-2 is a TRIAC-dimmable, offline LED lighting driver with an integrated 600V MOSFET. It can achieve a high power factor and accurate LED current control for lighting applications in a single-stage converter. The proprietary real-current control can accurately control the LED current.

The MP4032-2 has a power-factor-correction function and works in boundary-conduction mode that reduces power losses. The DRAIN pin can supply current to the internal charging circuit for start-up without a perceptible delay. The proprietary dimming control extends the TRIAC-based dimming range.

The multiple protections greatly enhance system reliability and safety. These protections include VCC under-voltage lockout, LED over-voltage and over-current protections, short-circuit protection, and over-temperature protection.

The MP4032-2 is available in an SOIC8-7A package.

FEATURES

- Internal MOSFET with 600V High Voltage Rating
- Internal Charging Circuit for Fast Start-Up
- Accurate Line Regulation
- Flicker-Free, Phase-Controlled TRIAC Dimming with Extended Dimming Range
- High Power Factor
- Boundary-Conduction Mode
- VCC UVLO
- Cycle-by-Cycle Current Limiting
- Over-Voltage Protection
- Short-Circuit Protection
- Over-Temperature Protection
- Available in SOIC8-7A Package

APPLICATIONS

- Solid-State Lighting
- Industrial and Commercial Lighting
- Residential Lighting

All MPS parts are lead-free and adhere to the RoHS directive. For MPS green status, please visit MPS website under Products, Quality Assurance page.

"MPS" and "The Future of Analog IC Technology" are registered trademarks of Monolithic Power Systems, Inc.

The MP4032-2 is patent pending.



Warning: Although this board is designed to satisfy safety requirements, the engineering prototype has not been agency approved. Therefore, all testing should be performed using an isolation transformer to provide the AC input to the prototype board.

TYPICAL APPLICATION

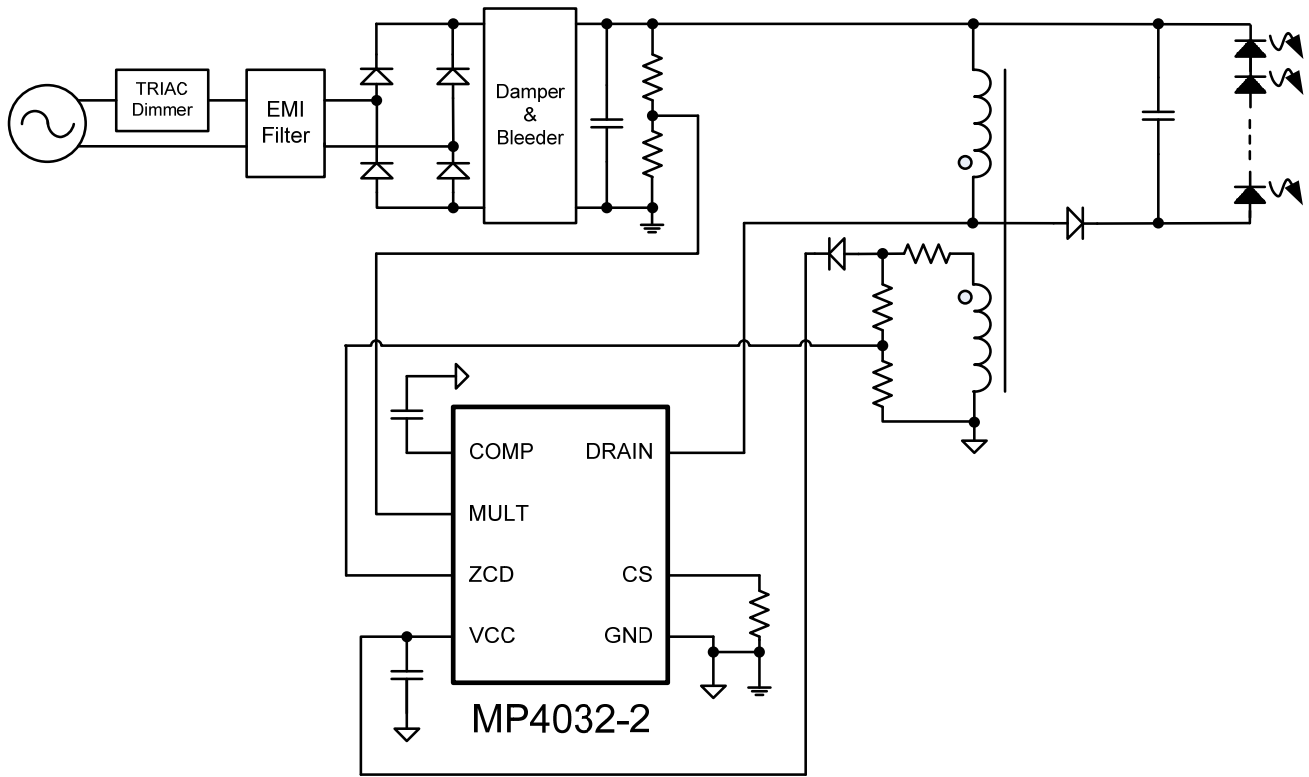

ORDERING INFORMATION

Part Number*	Package	Top Marking
MP4032-2GS	SOIC8-7A	MP4032-2

* For Tape & Reel, add suffix -Z (e.g. MP4032-2GS-Z)

PACKAGE REFERENCE

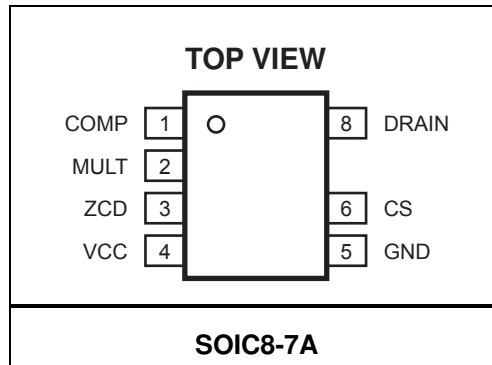

ABSOLUTE MAXIMUM RATINGS ⁽¹⁾

V _{CC}	-0.3V to +30V
ZCD Pin	-7V to +7V
Drain-Source Voltage	-0.3V to +600V
Continue Drain Current ⁽²⁾	1A
Other Analog Inputs and Outputs ...	-0.3V to +7V
Continuous Power Dissipation (T _A = +25°C) ⁽³⁾	1.3W
Junction Temperature	150°C
Lead Temperature	260°C
Storage Temperature.....	-65°C to +150°C

Recommended Operating Conditions ⁽⁴⁾

Supply Voltage V _{CC}	10.3V to 27V
--------------------------------------	--------------

<i>Thermal Resistance</i> ⁽⁵⁾	θ_{JA}	θ_{JC}
SOIC8-7A.....	96	45 ... °C/W

Notes:

- 1) Exceeding these ratings may damage the device.
- 2) Guaranteed by design.
- 3) The maximum allowable power dissipation is a function of the maximum junction temperature T_J(MAX), the junction-to-ambient thermal resistance θ_{JA} , and the ambient temperature T_A. The maximum allowable continuous power dissipation at any ambient temperature is calculated by P_D(MAX)=(T_J(MAX)-T_A)/ θ_{JA} . Exceeding the maximum allowable power dissipation will cause excessive die temperature, and the regulator will go into thermal shutdown. Internal thermal shutdown circuitry protects the device from permanent damage.
- 4) The device is not guaranteed to function outside of its operation conditions.
- 5) Measured on JESD51-7 4-layer board.

ELECTRICAL CHARACTERISTICS

Typical values are at $V_{CC} = 16V$, $T_J = 25^\circ C$, unless otherwise noted.

Minimum and maximum values are at $V_{CC} = 16V$, $T_J = -40^\circ C$ to $+125^\circ C$, unless otherwise noted, guaranteed by characterization.

Parameter	Symbol	Condition	Min	Typ	Max	Units
Supply Voltage						
Operating Range	V_{CC}	After turn-on	10.3		27	V
Turn-On Threshold	V_{CC_ON}	V_{CC} rising	13.0	13.8	14.6	V
Drain-Charger Starting Threshold	$V_{CC_CHG_NF}$	V_{CC} falling, no fault	8.9	9.5	10.1	V
	$V_{CC_CHG_F}$	V_{CC} falling, fault occurs	7.1	7.5	7.9	V
Hysteresis Voltage	$V_{CC_ON_CHG_HYS}$			4.5		V
	$V_{CC_CHG_HYS}$			2		V
Supply Current						
Drain Charger Supply Current	I_{CC_CHARGE}	Before system turns on	3.5	6	8	mA
Start-Up Current	$I_{STARTUP}$			150	195	μA
Quiescent Current	I_Q	No switching		900	1200	μA
		No switching, fault hiccup		500	670	μA
Operating Current	I_{CC}	$f_s = 70kHz$		1	1.25	mA
Multiplier						
Operation Range	V_{MULT}		0		3	V
Gain	$K^{(6)}$	$V_{COMP}=2V, V_{MULT}=0.5V$		1.1		1/V
		$V_{COMP}=2V, V_{MULT}=1.5V$		1.06		1/V
		$V_{COMP}=2V, V_{MULT}=3V$		0.99		1/V
Error Amplifier						
Reference Voltage	V_{REF}	$T_J = +25^\circ C$	0.389	0.403	0.417	V
		$T_J = +125^\circ C$	0.386	0.400	0.414	V
Transconductance ⁽²⁾	G_{EA}			125		$\mu A/V$
Lower Clamp Voltage	V_{COMP_L}		1.81	1.88	1.95	V
Max. Source Current ⁽²⁾	I_{COMP_SOURCE}			50		μA
Max. Sink Current ⁽²⁾	I_{COMP_SINK}			-350		μA
COMP OCP Threshold	V_{COMP_OCP}	V_{COMP} rising edge	4.8	5	5.2	V
Current Sense Comparator						
Leading-Edge Blanking Time	τ_{LEB}		200	310	420	ns
Current Sense Upper Clamp Voltage	$V_{CS_CLAMP_H}$		2.10	2.24	2.38	V
Current Sense Lower Clamp Voltage	$V_{CS_CLAMP_L}$		110	145	175	mV
Feedback Gain ⁽²⁾	K_{CS}	130 μs auto-switching mode & the output of Multiplier is <0.25V		0.05		
		Other conditions		1		

ELECTRICAL CHARACTERISTICS *(continued)*

 Typical values are at $V_{CC} = 16V$, $T_J = 25^\circ C$, unless otherwise noted.

 Minimum and maximum values are at $V_{CC} = 16V$, $T_J = -40^\circ C$ to $+125^\circ C$, unless otherwise noted, guaranteed by characterization.

Parameter	Symbol	Condition	Min	Typ	Max	Units
Zero Current Detector						
Zero Current Detect Threshold	V_{ZCD_T}	V_{ZCD} falling edge	0.30	0.35	0.40	V
Zero Current Detect Hysteresis	V_{ZCD_HYS}			0.55		V
ZCD Blanking Time	τ_{LEB_ZCD}	After turn-off	1.75	2.45	3.25	μs
Over-Voltage Blanking Time	τ_{LEB_OVP}	After turn-off	1.30	1.95	2.60	μs
Over-Voltage Threshold	V_{ZCD_OVP}	1.95 μs delay after turn-off	5.05	5.30	5.55	V
Minimum Off Time	τ_{OFF_MIN}	$T_J = +25^\circ C$	3.9	5.3	6.7	μs
Internal MOSFET						
Drain-Source Breakdown Voltage	BV_{DSS}	$dv/dt=10V/ns$	600			V
Drain-Source On-Resistance	$R_{DS(ON)}$	$V_{CC}=16V$, $I_D=200mA$	$T_J=25^\circ C$	6.5	9	Ω
			$T_J=125^\circ C$	10.5	14	
		$V_{CC}=UVLO+80mV$, $I_D=200mA$	$T_J=25^\circ C$	7	9.5	
			$T_J=125^\circ C$	11	15	
TRIAC Phase Dimming						
Maximum Dimming Phase		The max setting brightness	74	75	76	%
Dimming Detect Threshold	V_{MULT_H}	V_{MULT} rising edge	0.31	0.34	0.37	V
	V_{MULT_L}	V_{MULT} falling edge	0.125	0.15	0.175	V
Starter						
Start Timer Period	τ_{START}		95	130	175	μs
Thermal Shutdown						
Thermal Shutdown Threshold ⁽⁷⁾	T_{SD}			150		$^\circ C$
Thermal Shutdown Recovery Hysteresis ⁽⁷⁾	T_{HYS}			50		$^\circ C$

Notes:

 6) The multiplier output is given by: $V_{CS}=K \cdot V_{MULT} \cdot (V_{COMP}-1.5)$

7) Guaranteed by characterization.

TYPICAL CHARACTERISTICS

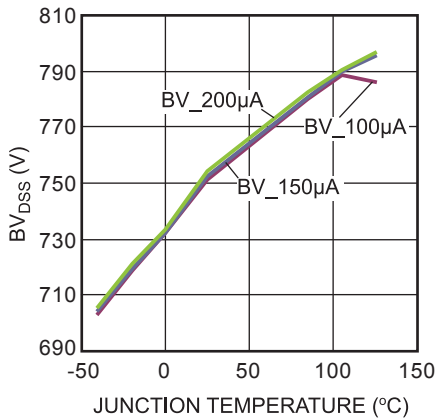
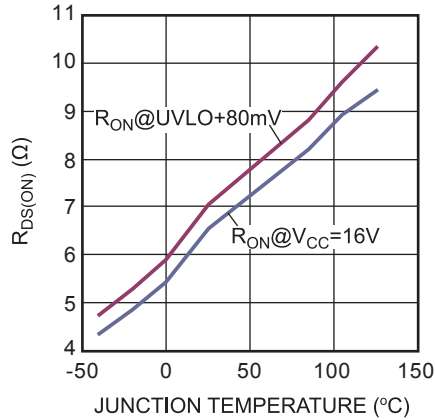
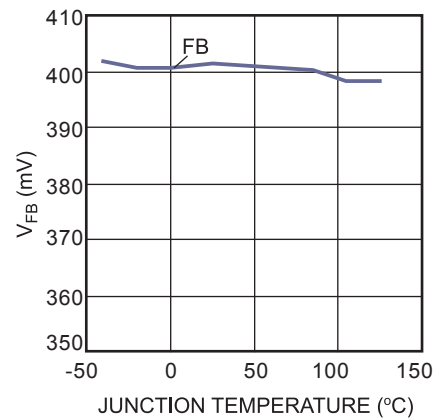
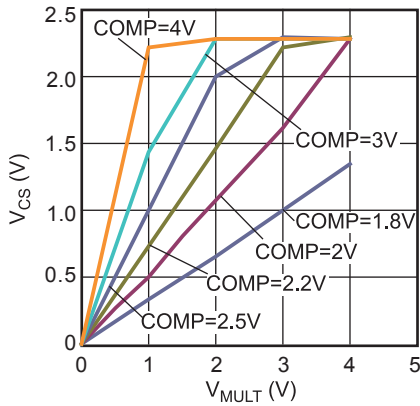
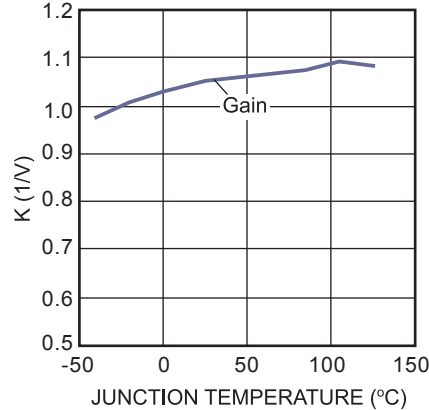
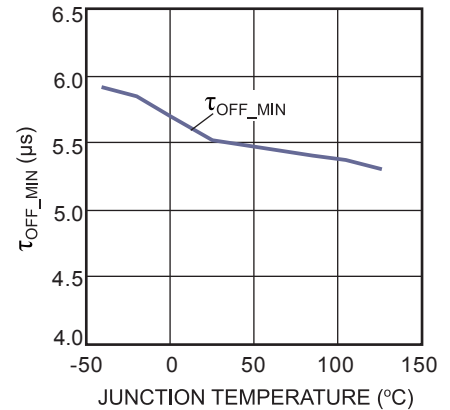
Breakdown Voltage vs. Junction Temperature

Drain-Source On-Resistance vs. Junction Temperature

Feedback Voltage vs. Junction Temperature

Multiplier Gain (K)

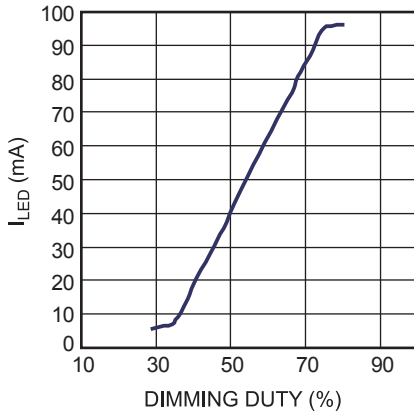
Multiplier Gain (K) vs. Junction Temperature

Minimum Off Time vs. Junction Temperature

TYPICAL PERFORMANCE CHARACTERISTICS

$V_{IN}=230VAC/50Hz$, 18 LEDs in series, $I_{LED}=98mA$, $V_{OUT}=55V$, $L_m=1.45mH$, TRIAC-dimmable, Non-isolated Buck-boost Converter, without ripple suppressor, unless otherwise noted.

Dimming Curve



Conducted EMI

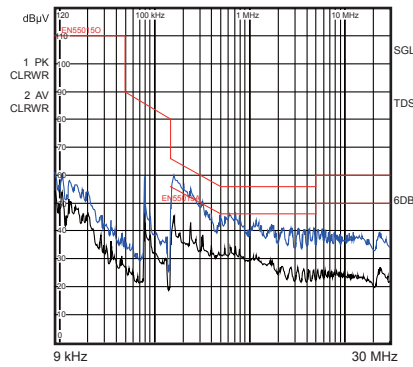

CDN Test

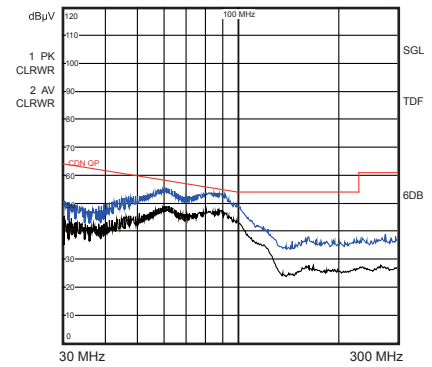

Efficiency vs. V_{IN}

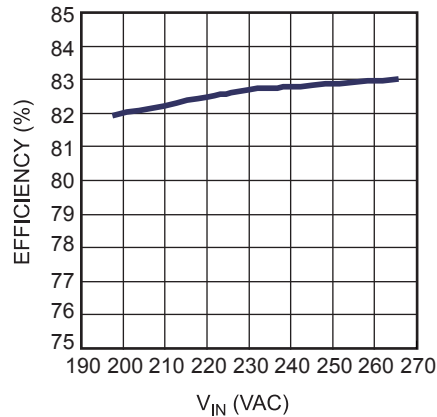

Line Regulation

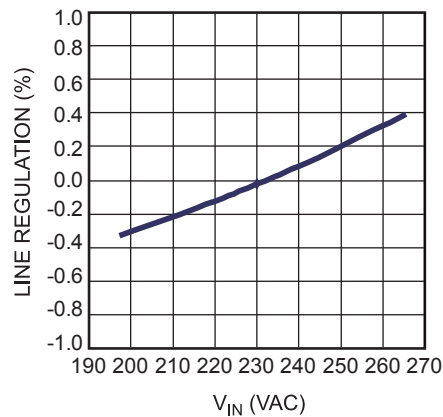

PF vs. V_{IN}

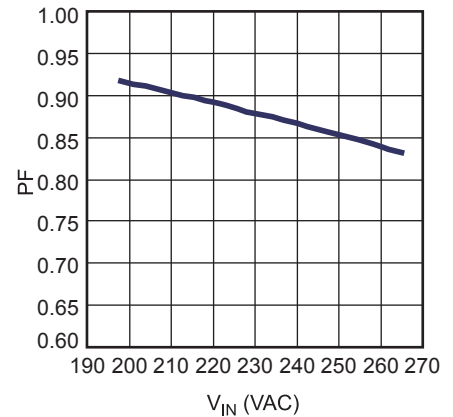

TYPICAL PERFORMANCE CHARACTERISTICS (continued)

$V_{IN}=230VAC/50Hz$, 18 LEDs in series, $I_{LED}=98mA$, $V_{OUT}=55V$, $L_m=1.45mH$, TRIAC-dimmable, Non-isolated Buck-boost Converter, without ripple suppressor, unless otherwise noted.

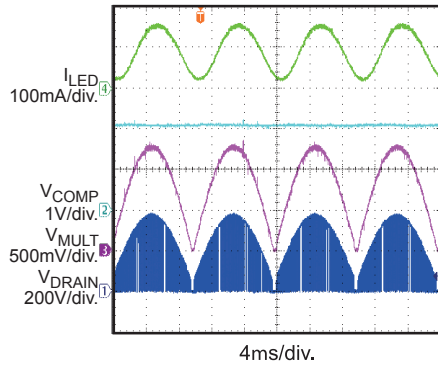
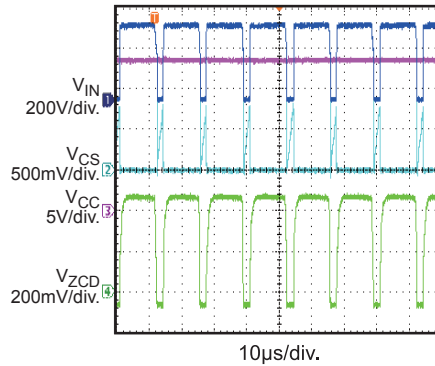
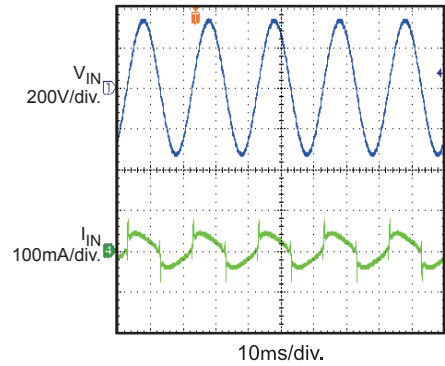
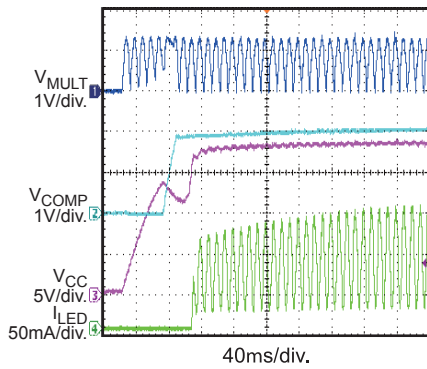
Steady State

Steady State

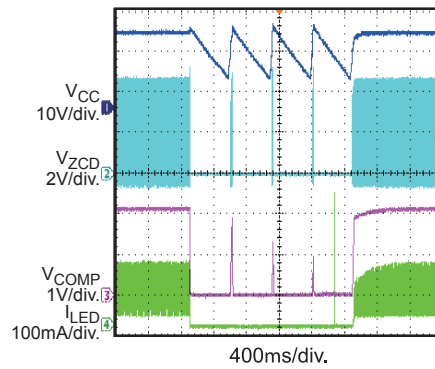
Steady State

 V_{IN} Start Up

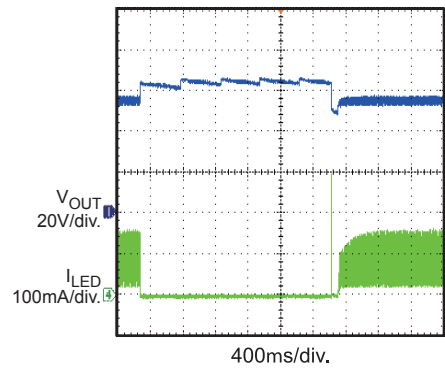
Open Voltage Protection

Open LED Load @ Normal Operation then Recovery

Open Voltage Protection

Open LED Load @ Normal Operation then Recovery

Short Circuit Protection

LED+ Short to LED-
@ Normal Operation then Recovery

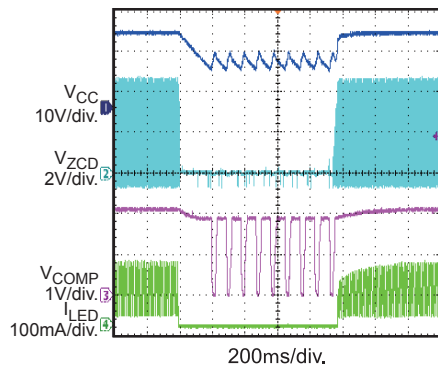

TYPICAL PERFORMANCE CHARACTERISTICS (continued)

$V_{IN}=230VAC/50Hz$, 18 LEDs in series, $I_{LED}=98mA$, $V_{OUT}=55V$, $L_m=1.45mH$, TRIAC-dimmable, Non-isolated Buck-boost Converter, without ripple suppressor, unless otherwise noted.

Dimming Performance

With Leading-Edge Dimmer
JUNG 266 GDE
Duty=80%

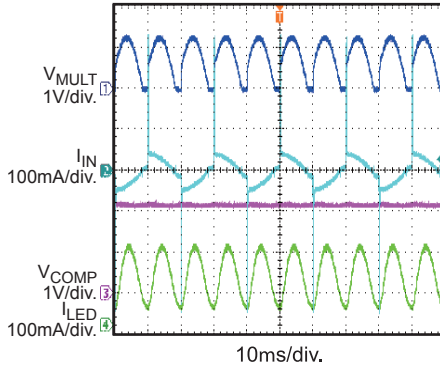
Dimming Performance

With Leading-Edge Dimmer
JUNG 266 GDE
Duty=50%

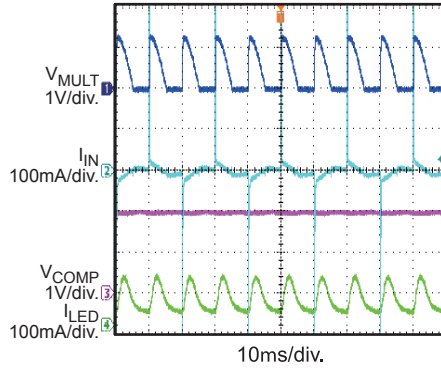
Dimming Performance

With Leading-Edge Dimmer
JUNG 266 GDE
Duty=30%

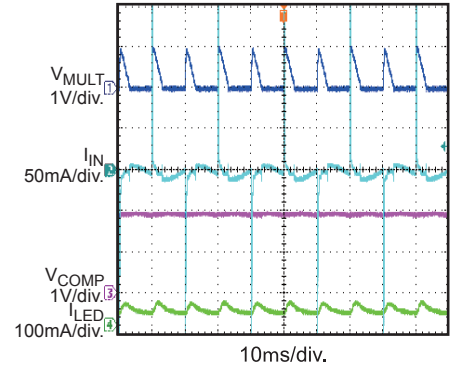
Dimming Performance

With Trailing-Edge Dimmer
MIKA EIM-585
Duty=76%

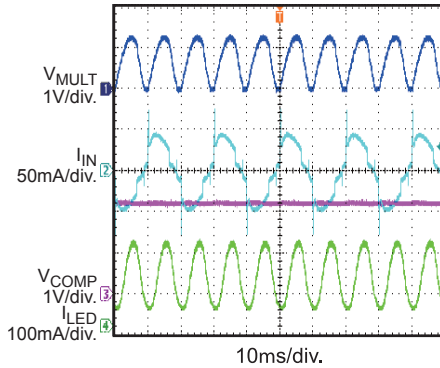
Dimming Performance

With Trailing-Edge Dimmer
MIKA EIM-585
Duty=50%

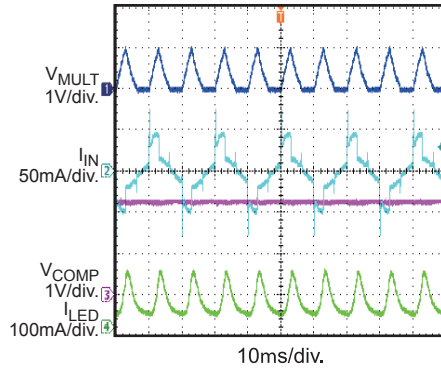
Dimming Performance

With Trailing-Edge Dimmer
MIKA EIM-585
Duty=30%

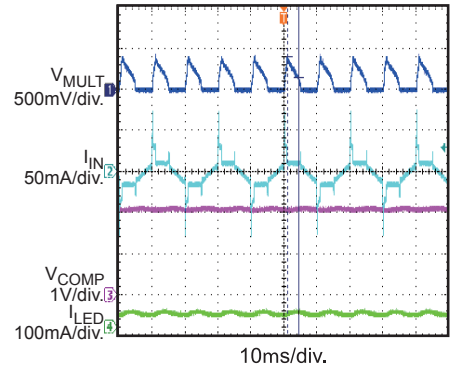

PIN FUNCTIONS

Pin #	Name	Pin Function
1	COMP	Loop Compensation. Connects a compensation network to stabilize the LED driver and get an accurate LED driver current.
2	MULT	Multiplier Input. Connect this pin to the tap of resistor divider from the rectified voltage of the AC line. The half-wave sinusoid signal on this pin provides a reference signal for the internal current control loop.
3	ZCD	Zero Current Detection Input. A negative going-edge triggers the turn-on signal of the internal MOSFET. Connect this pin to a resistor divider between the auxiliary winding to GND. Over-voltage condition is detected through ZCD. For each switching turn-off interval, if the ZCD voltage exceeds the over-voltage-protection (OVP) threshold after the 1.9 μ s blanking time, OVP will trigger and the system will stop switching until auto-restart.
4	VCC	Power Supply Input. Powers both the control signal and the internal high-voltage MOSFET gate driver. Bypass to ground with an external bulk capacitor (typically 22 μ F) to reduce ripple.
5	GND	Ground. Current return for the control signal and the gate drive signal.
6	CS	Internal MOSFET Source and Current Sense Input. Connect a current-sensing resistor from this pin to GND to set the LED current. Senses the MOSFET current. Comparing the resulting voltage and the internal sinusoidal-current reference signal determines when the MOSFET turns off. If the pin voltage exceeds the current limit threshold of 2.24V (after turn-on blanking) the gate drive will turn off.
7	NC	
8	DRAIN	Drain of the Internal MOSFET. Provides charging current from the rectified AC line voltage to VCC for start-up.

FUNCTION DIAGRAM

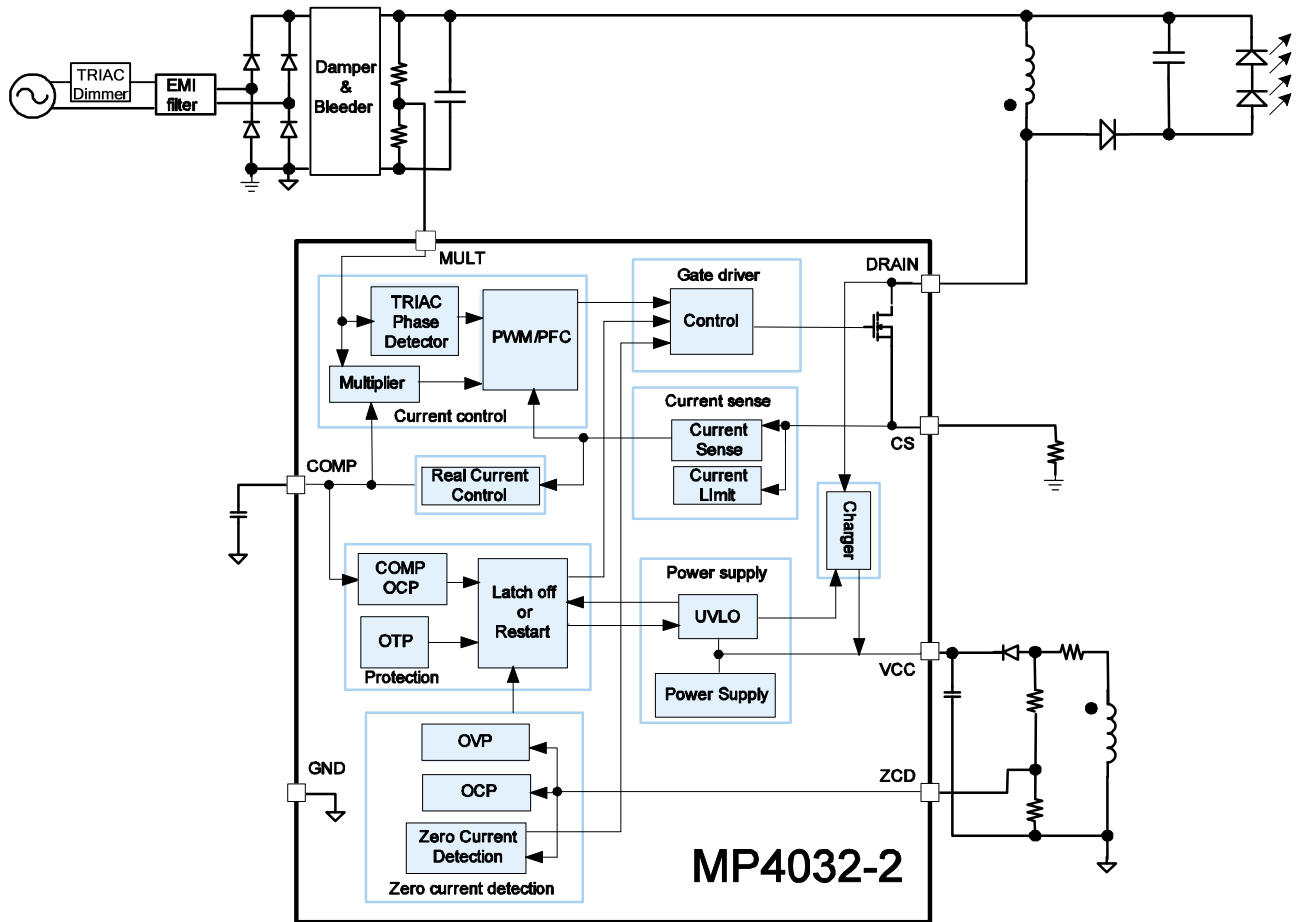

Figure 1: Functional Block Diagram

OPERATION

The MP4032-2 is a TRIAC-dimmable, offline LED driver with an integrated high-voltage MOSFET. It incorporates multiple features specifically for high-performance LED lighting. It uses a real-current-control method to accurately control LED current. It can achieve a high power factor to eliminate pollution on the AC-line.

System Start-Up and Power Supply

The VCC pin supplies power to both the control signal and the gate drive signal. After connecting the AC line, the VCC capacitor charges from the DRAIN pin through an internal high-voltage DRAIN charger. Once VCC reaches 13.8V, the control logic initiates and the gate drive signal forces the integrated high-voltage power MOSFET to begin switching for normal operation. Meanwhile, the DRAIN charger stops. The auxiliary winding takes over the power supply after charging.

If V_{CC} drops below 9.5V without fault, the DRAIN charger resumes function to charge V_{CC} back to 13.8V. If a fault occurs, the system stops switching and the auto-restart function activates once V_{CC} drops to 7.5V.

Power-Factor Correction

The MULT pin connects to the tap of the resistor divider from the rectified instantaneous line voltage. It is one of the inputs of the Multiplier. The multiplier's output has a sinusoidal shape. This signal provides the reference for the current comparator, and is compared with the inductor current sensed by the CS pin: The CS pin shapes the inductor peak-current envelope sinusoid to match the input line voltage. This control method can achieve a high power factor.

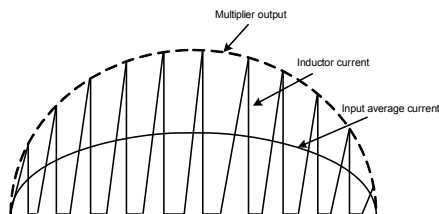

Figure 2: Power-Factor Correction

The maximum voltage of the multiplier output to the current comparator is clamped to 2.24V to limit the cycle-by-cycle current.

Boundary-Conduction Mode

During the internal MOSFET ON time (τ_{ON}), the rectified input voltage (V_{BUS}) applies to the inductor (L_m), and the inductor current (I_L) increases linearly from zero to the peak value (I_{pk}). When the internal MOSFET turns off, the energy stored in the inductor transfers to the LED load and turns on the output rectifier diode to power the load. The inductor current (I_L) then decrease linearly from the peak value to zero. When the inductor current reaches zero, the magnetizing inductance and all the parasitic capacitances decrease the MOSFET drain-source voltage—this decrease is also reflected on the auxiliary winding (see Figure 3). The zero-current detector on the ZCD pin generates the internal MOSFET's turn-on signal when the ZCD voltage falls below 0.35V, and ensures that the MOSFET turns on at a valley voltage (see Figure 4).

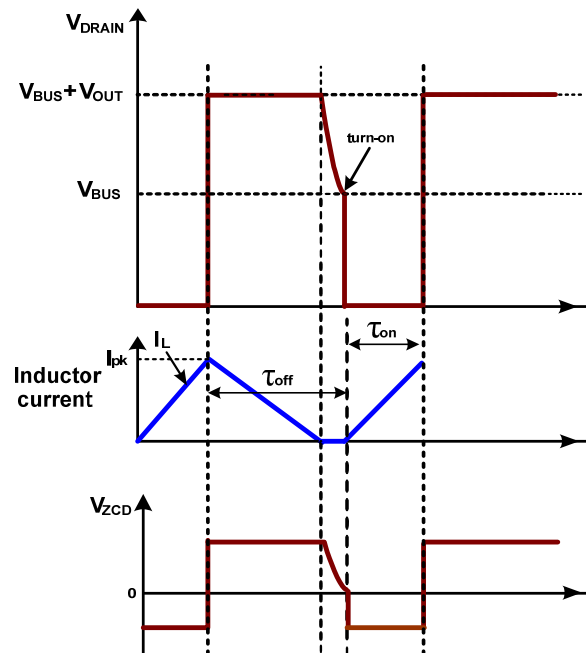
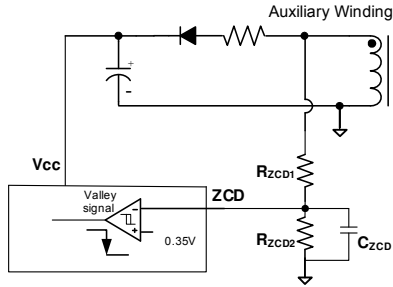

Figure 3: Boundary-Conduction Mode

Figure 4: Zero-Current Detector

As a result, there are virtually no switch turn-on losses and no output diode reverse-recover losses. It ensures high efficiency and low EMI noise.

Real-Current Control

The proprietary real-current control allows the MP4032-2 to control the LED current by sampling the inductor current information through the CS sensing resistor. The mean output LED current is approximately:

$$I_o \approx \frac{V_{FB}}{2 \cdot R_s}$$

Where:

V_{FB} is the internal reference voltage (typically 0.403V)

R_s is the sensing resistor connected between the CS pin and GND.

Auto Start

The MP4032-2 integrates an auto starter. The starter begins a timer when the MOSFET turns on. If ZCD fails to send out another turn-on signal after 130 μ s, the starter will automatically send a turn-on signal to avoid unnecessary IC shutdowns from a missed zero-current detection.

Minimum Off Time

The MP4032-2 operates with variable switching frequency. The frequency changes with the instantaneous input line voltage. To limit the maximum frequency and improve EMI performance, the MP4032-2 employs an internal minimum off-time limiter, with a minimum off-time of 5.3 μ s.

Leading-Edge Blanking

An internal leading-edge blanking (LEB) unit is employed between the CS pin and the current comparator input to prevent the switching pulse from prematurely terminating due to parasitic capacitance discharge when the MOSFET turns on. During the blanking time, the path from the CS pin to the current comparator input is blocked. Figure 5 shows the leading-edge blanking.

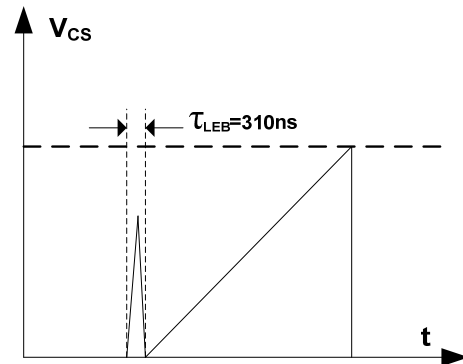
Figure 5: Leading-Edge Blanking

Output Over-Voltage Protection (OVP)

Output over-voltage protection can prevent component damage during an over-voltage condition. Since the auxiliary winding's positive voltage plateau is proportional to the output voltage, OVP uses the auxiliary winding voltage through the ZCD over-voltage detector instead of directly monitoring the output voltage. The OVP sampling unit is shown in Figure 6. Once the ZCD pin voltage exceeds 5.3V, the OVP signal triggers and latches, the gate driver turns off, and the IC functions in quiescent mode until the VCC voltage drops to 7.5V, which causes the system to restart. The output OVP setting point can be calculated as:

$$V_{OUT_OVP} \cdot \frac{N_{AUX}}{N_L} \cdot \frac{R_{ZCD2}}{R_{ZCD1} + R_{ZCD2}} = 5.3V$$

V_{OUT_OVP} is the output over-voltage protection threshold,

N_{AUX} is the number of auxiliary winding turns

N_L is the number of inductor winding turns.

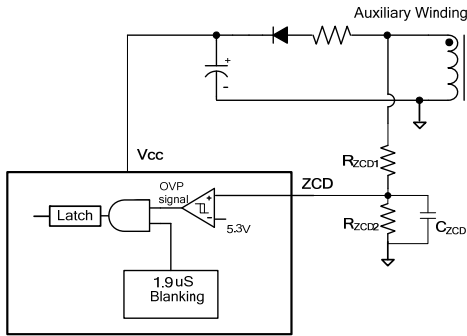
Figure 6: Over-Voltage Sampling Unit

To avoid an oscillation spike mis-triggering the OVP after the switch turns off, the OVP has a blanking period, as shown in Figure 7. The blanking period (τ_{LEB_OVP}) is typically $1.95\mu s$.

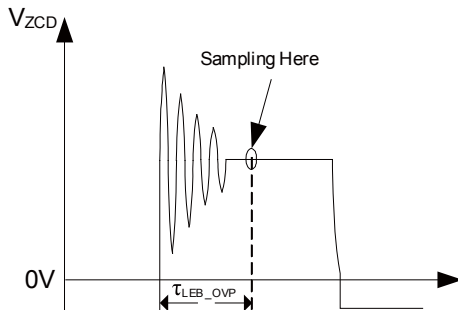
Figure 7: ZCD Voltage and OVP Sampling

Over-Current Protection

The MP4032-2 clamps the CS pin voltage $<2.24V$ to limit the available output power. If a short circuit on LED load occurs, the ZCD pin can't detect the zero-crossing signal and triggers a $130\mu s$ auto-restart process. The COMP voltage drops and the inductor peak current falls, thus limiting the SC current. Meanwhile, the auxiliary winding voltage falls following the output voltage, V_{CC} drops below $9.5V$, and the system restarts. Furthermore, once the COMP level exceeds $5V$, the COMP OCP triggers and the system stops switching until V_{CC} drops to $7.5V$ UVLO, and the system auto-restarts.

Thermal Shutdown

To prevent thermal damage, the MP4032-2 shuts off switching and remains latched once the inner temperature exceeds the OTP threshold. When V_{CC} drops below $7.5V$, the system restarts.

TRIAC-Phase Dimming

The MP4032-2 can implement TRIAC-based dimming. As shown in Figure 8, the TRIAC dimmer is a bi-directional SCR with an adjustable turn-on phase. The MP4032-2 detects the dimming phase signal on the MULT pin that feeds the signal into the control loop for the dimming control.

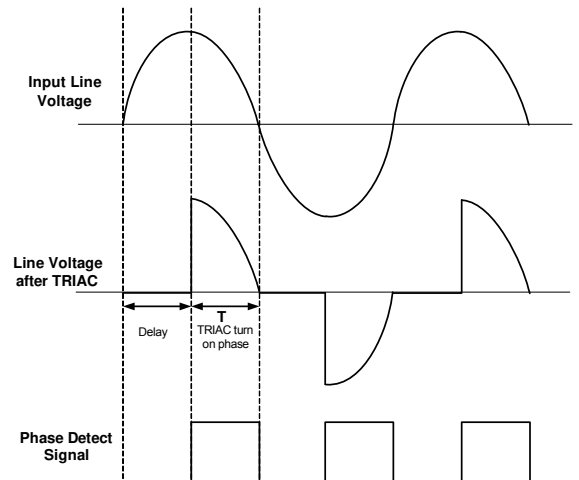
Figure 8: TRIAC-Phase Detection Signal for a Leading-Edge TRIAC Dimmer

APPLICATION INFORMATION

Components Selection

(Please refer to Application Note AN055 for detailed design)

Input EMI Filter

Select EMI component values to pass EMI test standards, as well as to account for the power factor and inrush current when dimming turns on. The input capacitance plays a primary role: a small input capacitance can increase the power factor and decrease the inrush current, so select a relatively small X capacitor.

Input Bridge

The input bridge can use standard, slow-recovery, low-cost diodes. When selecting diodes, take into account these three items: the maximum input RMS current; the maximum-input-line voltage; and thermal performance.

Input Capacitor

The input capacitor mainly provides the transformer's switching frequency magnetizing current. The maximum current occurs at the peak of the input voltage. Limit the capacitor's maximum high-frequency voltage ripple to 10%, or the voltage ripple may cause more peak-current spikes and degrade both the power loss and the EMI performance.

$$C_{in} > \frac{I_{pk_max} - \sqrt{2}I_{inductor_rms_max}}{2 \cdot \pi \cdot f_{s_min} \cdot V_{ac_min} \cdot 0.1}$$

Input capacitor selection requires taking into account the EMI filter, the power factor, and the surge current at the dimming turn-on time. A large capacitor improves EMI, but limits the power factor and increases the inrush current.

Passive Bleeder and Active Damper

Since the LED lamp impedance is relatively large, significant ringing occurs when the leading-edge TRIAC dimmer turns on due to an inrush current charging the input capacitance. The ringing may cause the TRIAC current to fall below the holding current and turn off the TRIAC dimmer, which can cause flickering.

The typical application circuit incorporates both a passive bleeder and an active damping circuit to address this issue. The design details can be found in the corresponding design tools.

Inductor

Usually, the system will define a minimum frequency f_{s_min} at the peak of V_{ac_min} . So setting the value of f_{s_min} can get the inductance L_m . The design details can also be found in the design tools.

Output Rectifier Diode

Choose a diode with an appropriate reverse-voltage rating and current rating. The reverse recovery of the freewheeling diode can affect the efficiency and circuit operation, and a Schottky or ultra-fast diode is recommended.

Output Capacitor

The output voltage ripple has two components: the switching-frequency ripple associated with the converter, and the low-frequency ripple associated with the input-line voltage (100/120Hz). Selecting the output bulk capacitor depends on the LED current ripple, the allowable overvoltage and the desired voltage ripple.

Meanwhile, a pre-load resistor is necessary to discharge the output voltage under open-load conditions.

MULT Pin Resistor Divider

The MULT pin resistor divider requires careful tuning because the MULT voltage determines the COMP voltage level, which directly influences the dimming curve and performance. Test the estimated divider values with different types of TRIAC dimmers to determine precise resistor values: typically use the divider for a COMP level of 2.3V at 120VAC input.

Add a ceramic X7R capacitor to the MULT pin to absorb the switching-frequency ripple on the MULT voltage for accurate dimming-phase detection. Increasing the capacitance can further smooth the MULT voltage, but increase the input-line voltage phase shift and diminish the power factor. Typical values are between 2.2nF and 8.2nF.

VCC Power Supply

After the system starts up, the auxiliary winding takes over the VCC power supply through a rectifying diode with a relatively small current-limiting resistor because of the limited power dissipation. The bulk capacitor stabilizes the VCC voltage to limit the ripple—most applications use 22 μ F. Use the following equation to determine the voltage rating of the rectifying diode:

$$V_D > VCC_{\max} + \frac{N_{\text{aux}}}{N_L} \cdot V_{\text{in_max}} + V_{\text{aux_negative_spike}}$$

Where VCC_{\max} is the maximum VCC voltage, typically 27V, N_{aux} and N_L are the auxiliary winding and inductor winding turns, $V_{\text{aux_negative_spike}}$ is the maximum negative spike on auxiliary winding.

Layout Guide

PCB layout is very important to achieve reliable operation, and good EMI and thermal performance. Follow these guidelines to optimize performance.

- 1) Design a short main-power path. Directly connect the sense resistor GND return to the input capacitor. Use the largest-possible copper pour for the power devices for good thermal performance.
- 2) Separate the power GND and the analog GND, and connect them together only at an IC GND pin.
- 3) Place the components as close as possible to the corresponding IC pins. The ZCD pin bypass capacitor and the COMP pin capacitor have priority.
- 4) Separate the input high voltage wire from other components and GND to avoid surge failures. Select the pull-down resistors for the BUS line to the active damping circuit and the MULT pin for the DIP package.
- 5) Place the output rectifying diode as close as possible to the output filter capacitor, and use a short trace from the inductor output return pin to the return point of the output filter capacitor.

RIPPLE SUPPRESSOR

(Innovative Proprietary)

For dimming LED lighting application, a single stage PFC converter needs large output capacitor to reduce the ripple whose frequency is double of the Grid. And in deep dimming situation, the LED would have shimmer caused by the dimming on duty which is not all the same in every line cycle. What's more, the Grid has noise or inrush which would bring out shimmer even flicker. Figure 9 shows a ripple suppressor, which can shrink the LED current ripple obviously.

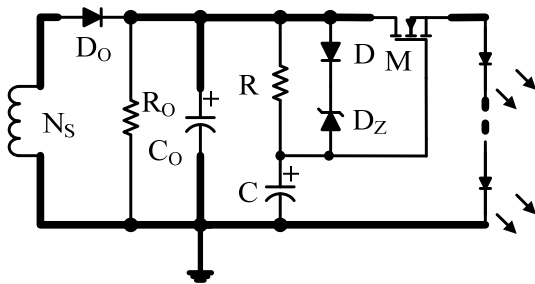

Figure9: Ripple Suppressor

Principle

Shown in Figure 9, Resistor R, capacitor C, and MOSFET M compose the ripple suppressor. Through the RC filter, C gets the mean value of the output voltage V_{Co} to drive the MOSFET M. M works in variable resistance area. C's voltage V_C is steady makes the LEDs voltage is steady, so the LEDs current will be smooth. MOSFET M holds the ripple voltage v_{Co} of the output.

Diode D and Zener diode D_Z are used to restrain the overshoot at start-up. In the start-up process, through D and D_Z , C is charged up quickly to turn on M, so the LED current can be built quickly. When V_C rising up to about the steady value, D and D_Z turn off, and C combines R as the filter to get the mean voltage drop of V_{Co} .

The most important parameter of MOSFET M is the threshold voltage V_{th} which decides the power loss of the ripple suppressor. Lower V_{th} is better if the MOSFET can work in variable resistance area. The BV of the MOSFET can be selected as double as V_{Co} and the Continuous Drain current level can be selected as decuple as the LEDs' current at least.

About the RC filter, it can be selected by $\tau_{RC} \geq 50/f_{LineCycle}$. Diode D can select 1N4148, and the Zener voltage of D_Z is as small as possible when guarantee $V_D + V_{DZ} > 0.5 \cdot V_{Co_PP}$.

Optional Protection Circuit

In large output voltage or large LEDs current application, MOSFET M may be destroyed by over-voltage or over-current when LED+ shorted to LED- at working.

Gate-Source (GS) Over-voltage Protection

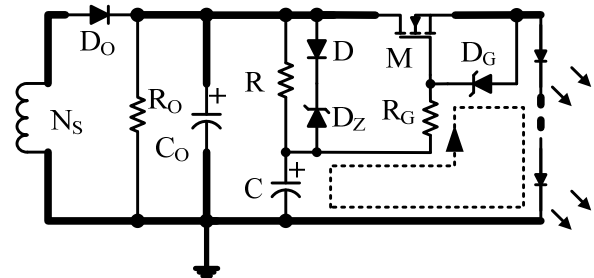

Figure 10: Gate-Source OVP Circuit

Figure 10 shows GS over-voltage protection circuit. Zener diode D_G and resistor R_G are used to protect MOSFET M from GS over-voltage damaged. When LED+ shorted to LED- at normal operation, the voltage drop on capacitor C is high, and the voltage drop on Gate-Source is the same as capacitor C. The Zener diode D_G limits the voltage V_{GS} and R_G limits the charging current to protect D_G . R_G also can limit the current of D_Z at the moment when LED+ shorted to LED-. V_{DG} should bigger than V_{th} .

Drain-Source Over-voltage and Over-current Protection

As Figure 11 shows, NPN transistor T, resistor R_C and R_E are set up to protect MOSFET M from over-current damaged when output short occurs at normal operation. When LED+ shorted to LED-, the voltage v_{DS} of MOSFET is equal to the v_{Co} which has a high surge caused by the parasitic parameter. Zener Diode D_{DS} protects MOSFET from over-voltage damaged. Transistor T is used to pull down the V_{GS} of M. When M turns off, the load is opened, then the OVP mode is triggered,

and the IC functions in quiescent. The pull down

point is set by R_C and R_E : $\frac{R_E}{R_C+R_E} \cdot \frac{V_{CO}}{2} = 0.7V$.

MOSFET LIST

In the Table 1, there are some recommended MOSFET for ripple suppressor.

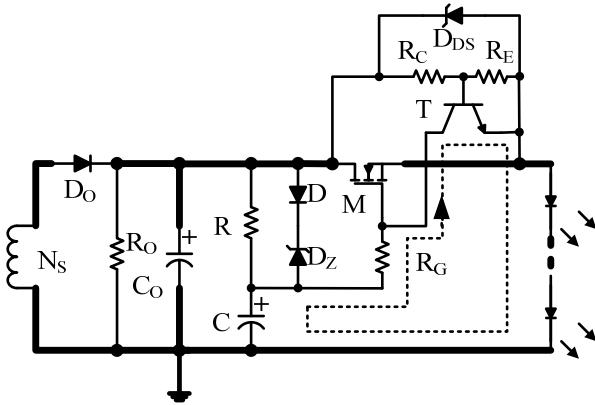

Figure 11: Drain-Source OVP and OCP Circuit

Table 1: MOSFET LIST

Manufacture P/N	Manufacture	V_{DS}/I_D	$V_{th}(V_{DS}=V_{GS}@T_J=25^\circ C)$	Package	Power Stage
Si4446DY	Vishay	40V/3A	0.6-1.6V@ $I_D=250\mu A$	SO-8	<10W
FTD100N10A	IPS	100V/17A	1.0-2.0V@ $I_D=250\mu A$	TO-252	5-15W
P6015CDG	NIKO-SEM	150V/20A	0.45-1.20V@ $I_D=250\mu A$	TO-252	10-20W
EMF65N15A	Excelliancemos	150V/20A	0.45-1.20V@ $I_D=250\mu A$	TO-252	10-20W

TYPICAL APPLICATION CIRCUIT

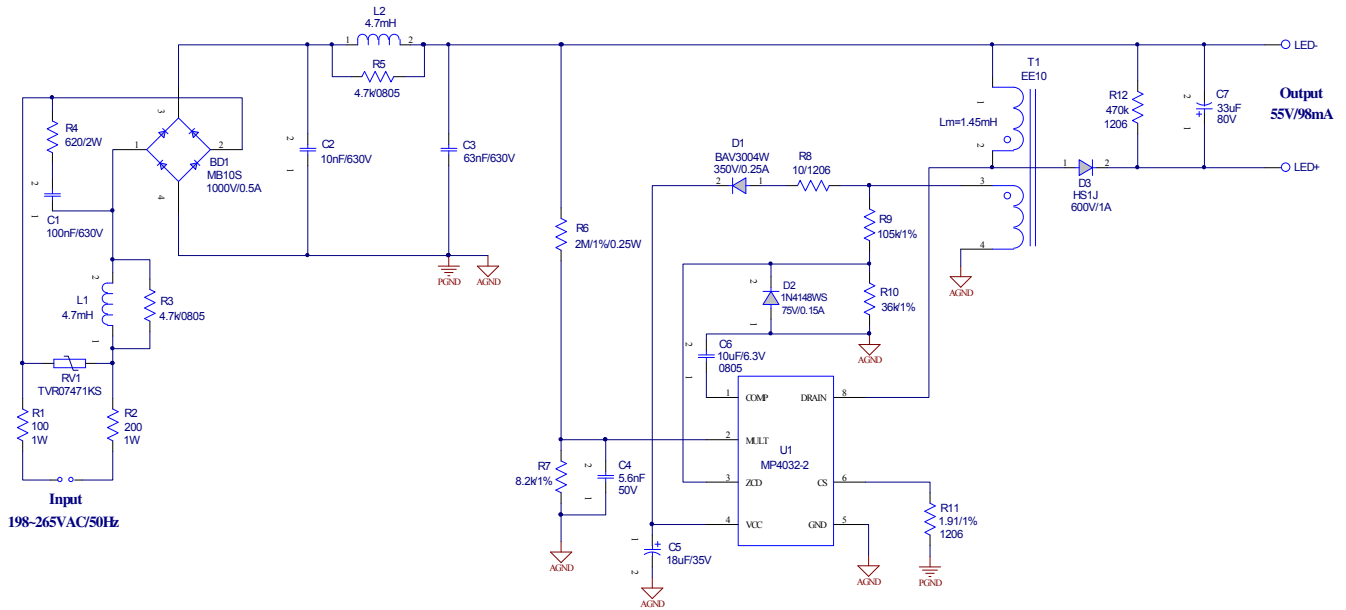
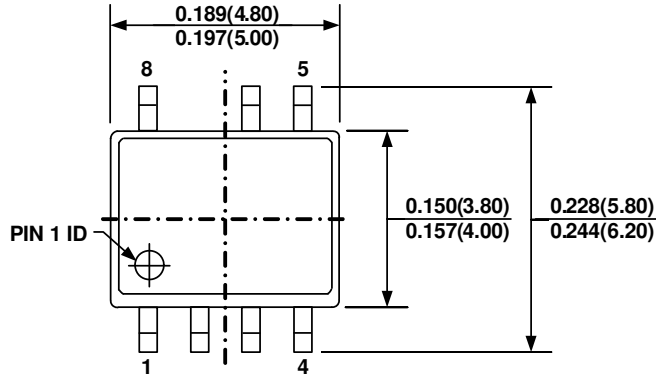

Figure 12: 198VAC-265VAC/50Hz Input, Non-isolated Buck-boost Converter with a 55V/98mA Output for TRIAC-dimmable GU10 LED Bulb

PACKAGE INFORMATION

SOIC8-7A



TOP VIEW

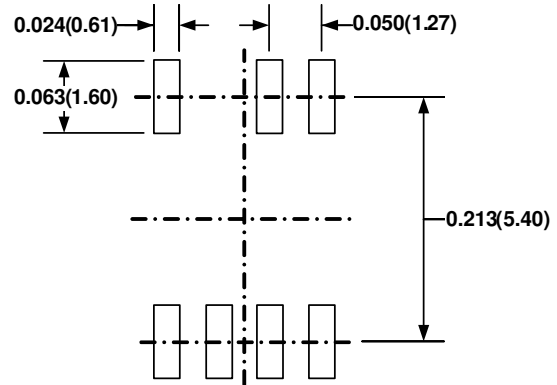

RECOMMENDED LAND PATTERN

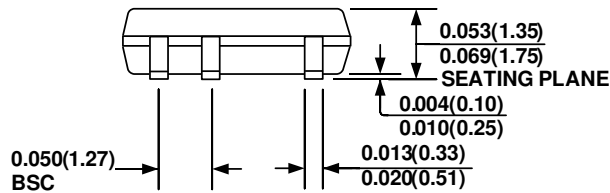

FRONT VIEW

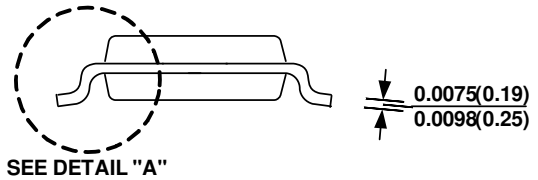

SIDE VIEW

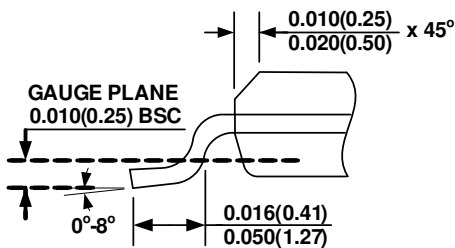

DETAIL "A"

NOTE:

- 1) CONTROL DIMENSION IS IN INCHES DIMENSION IN BRACKET IS IN MILLIMETERS
- 2) PACKAGE LENGTH DOES NOT INCLUDE MOLD FLASH, PROTRUSIONS OR GATE BURRS
- 3) PACKAGE WIDTH DOES NOT INCLUDE INTERLEAD FLASH OR PROTRUSIONS.
- 4) LEAD COPLANARITY(BOTTOM OF LEADS AFTER FORMING) SHALL BE 0.004" INCHES MAX.
- 5) JEDEC REFERENCE IS MS-012.
- 6) DRAWING IS NOT TO SCALE

NOTICE: The information in this document is subject to change without notice. Users should warrant and guarantee that third party Intellectual Property rights are not infringed upon when integrating MPS products into any application. MPS will not assume any legal responsibility for any said applications.