



Chipsmall Limited consists of a professional team with an average of over 10 year of expertise in the distribution of electronic components. Based in Hongkong, we have already established firm and mutual-benefit business relationships with customers from,Europe,America and south Asia,supplying obsolete and hard-to-find components to meet their specific needs.

With the principle of “Quality Parts,Customers Priority,Honest Operation,and Considerate Service”,our business mainly focus on the distribution of electronic components. Line cards we deal with include Microchip,ALPS,ROHM,Xilinx,Pulse,ON,Everlight and Freescale. Main products comprise IC,Modules,Potentiometer,IC Socket,Relay,Connector.Our parts cover such applications as commercial,industrial, and automotives areas.

We are looking forward to setting up business relationship with you and hope to provide you with the best service and solution. Let us make a better world for our industry!



Contact us

Tel: +86-755-8981 8866 Fax: +86-755-8427 6832

Email & Skype: info@chipsmall.com Web: www.chipsmall.com

Address: A1208, Overseas Decoration Building, #122 Zhenhua RD., Futian, Shenzhen, China





The Future of Analog IC Technology®

MP5414

PMU for 3D Glasses

DESCRIPTION

The MP5414 is a highly-efficient fully-integrated PMU with a current-mode step-up converter, four single-pole/double-throw switches, low drop-out, and a battery charger designed for battery-powered supply applications.

The step-up converter can start-up from an input voltage as low as 1.8V. It uses a current-limited variable-frequency control algorithm to optimize efficiency and minimize external component size and cost. The internal low-resistance N-Channel MOSFET switch can withstand up to 10V, allowing the MP5414 to produce a high output voltage with high efficiency from a dual-cell NiCd/NiMH or single-cell Li-ion battery. In addition, the step-up converter can disconnect all loads from the input DC power supply.

The charger features constant-current and constant-voltage charging modes with a programmable charge current (50mA to 300mA), trickle-charge capability, and a charge-status indicator. Charging is enabled with an input voltage greater than 3.5V, and is disabled when unplugged from the AC adaptor. The charger does not need an external reverse-blocking diode.

The low-dropout linear regulator operates with low noise from a 2.7V-to-6.5V input voltage, and regulates the output voltage with 2% accuracy from 1.25V to 5V.

The MP5414 is available in a 4mm x 5mm 28-pin QFN package.

FEATURES

BOOST

- 1.8V Low Voltage Start-Up
- 1.8V to 5.5V Input Range
- Output Disconnect
- Integrated Power MOSFET and Schottky Diode
- Variable Frequency Control
- <1 μ A Shutdown Current
- Current Mode Control with Internal Compensation
- Inrush Current Limiting and Internal Soft-Start
- Input Under-Voltage Lockout

CHARGER

- 0.75% V_{BATT} Accuracy
- Low Reverse-Battery Current (< 1 μ A)
- Programmable Charge Current
- Charge Status Indication
- No External Sense Resistor
- No External Reverse Blocking Diode

LINEAR REGULATOR

- Low 100mV Dropout at 100mA Output
- Programmable Output Voltage with 2% Accuracy
- Up to 6.5V Input Voltage
- High PSRR: 70dB at 1kHz
- Better Than 0.001%/mA Load Regulation
- Stable With Low-ESR Output Capacitor

APPLICATIONS

- 2-Cell and 3-Cell NiCd/NiMH or Single-cell Li-Ion Battery Consumer Products
- 3D Glass Driver
- Small LCD Displays Bias Supply
- Digital Still and Video Cameras
- Smartphones, Netbooks, and Handheld Video Game Consoles

All MPS parts are lead-free and adhere to the RoHS directive. For MPS green status, please visit MPS website under Quality Assurance. "MPS" and "The Future of Analog IC Technology" are Registered Trademarks of Monolithic Power Systems, Inc.

TYPICAL APPLICATION

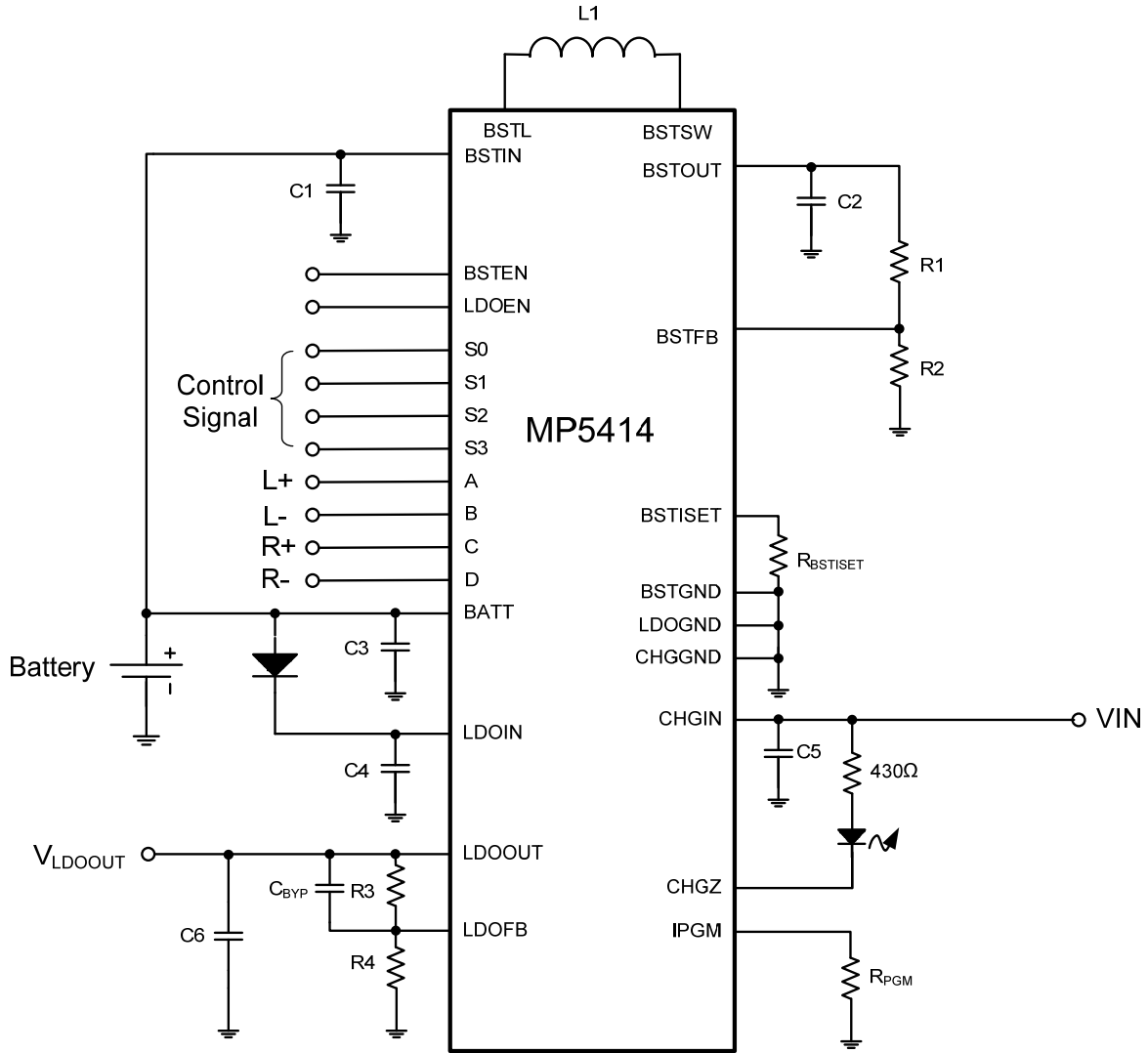

ORDERING INFORMATION

Part Number*	Package	Top Marking
MP5414DV	QFN28 (4x5mm)	MP5414

* For Tape & Reel, add suffix -Z (e.g. MP5414DV-Z);
 For RoHS Compliant Packaging, add suffix -LF (e.g. MP5414DV-LF-Z)

PACKAGE REFERENCE

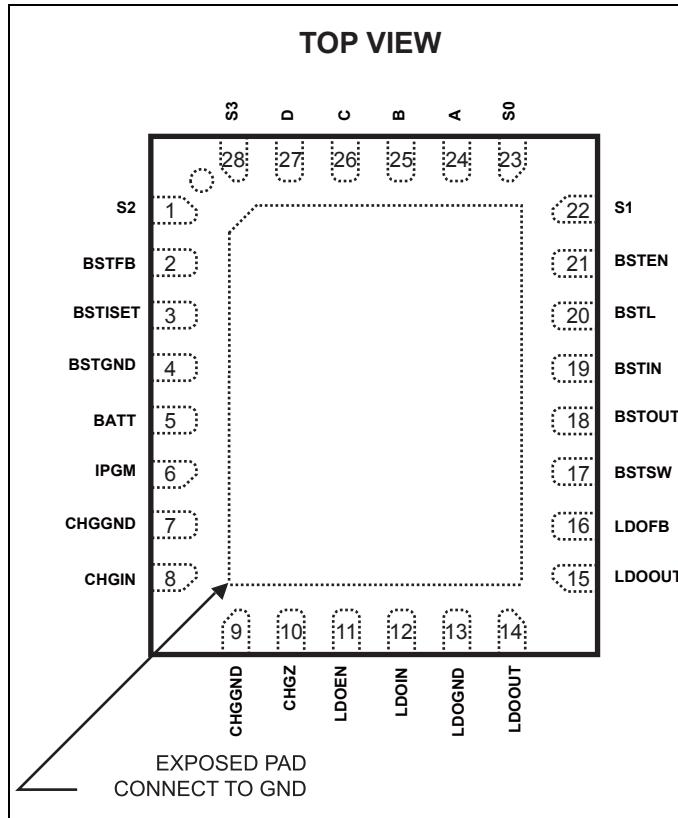

ABSOLUTE MAXIMUM RATINGS ⁽¹⁾

BSTSW, A, B, C, D to BSTGND ...	-0.5V to +12V
CHGIN to CHGGND	-0.3V to +25V
LDOIN to LDOGND.....	-0.3V to +7.0V
LDOFB to LDOGND....	-0.3V to (V _{LDOOUT} + 0.3V)
All other Pins.....	-0.3V to +6.0V
Continuous Power Dissipation (T _A = 25°C) ⁽²⁾	3.1 W
Junction Temperature	140°C
Lead Temperature	260°C
Storage Temperature.....	-65°C to +150°C

Recommended Operating Conditions ⁽³⁾

V _{BSTIN}	1.8V to 5.5V
V _{BSTOUT}	V _{BSTIN} to 10V
V _{CHGIN}	4.75V to 5.25V
V _{LDOIN}	2.7V to 6.5V
V _{LDOOUT}	1.25V to 5V
I _{LDOOUT}	250mA Maximum
Operating Junction Temp. (T _J).	-40°C to +125°C

Thermal Resistance ⁽⁴⁾	θ_{JA}	θ_{JC}
QFN28 (4x5mm)	40	9
	°C/W	

Notes:

- 1) Exceeding these ratings may damage the device.
- 2) The maximum allowable power dissipation is a function of the maximum junction temperature T_J(MAX), the junction-to-ambient thermal resistance θ_{JA}, and the ambient temperature T_A. The maximum allowable continuous power dissipation at any ambient temperature is calculated by P_D(MAX)=(T_J(MAX)-T_A)/ θ_{JA}. Exceeding the maximum allowable power dissipation will cause excessive die temperature, and the regulator will go into thermal shutdown. Internal thermal shutdown circuitry protects the device from permanent damage.
- 3) The device is not guaranteed to function outside of its operation conditions.
- 4) Measured on JESD51-7 4-layer board.

ELECTRICAL CHARACTERISTICS

$V_{BSTIN} = 2.4V$, $V_{BSTOUT} = 10V$, $I_{BSTOUT} = 2mA$, $V_{CHGIN} = V_{LDOIN} = 5V$, $T_A = 25^\circ C$, unless otherwise noted.

Parameters	Symbol	Condition	Min	Typ	Max	Units
Step-Up Converter						
Operating Input Voltage	V_{BSTIN}		1.8		5.5	V
Minimum Startup Voltage	V_{BSTST}	$V_{BSTOUT} = 0V$			1.8	V
Quiescent Current	I_{BSTQ_NS}	$I_{BSTOUT} = 0$, $V_{BSTFB} = 1.3V$, No switching		28	50	μA
Shutdown Current	I_{BSTSD}	$V_{BSTEN} = 0V$		0.1	1	μA
IN Under Voltage Lockout	$V_{BSTUVLO}$	V_{BSTIN} Rising		1.58	1.7	V
Under Voltage Lockout Hysteresis				100		mV
Maximum On Time	T_{BSTON}		4	6	7.5	μs
Minimum Off Time	T_{BSTOFF}		400	550	700	ns
SW On-Resistance	R_{BSTDS_ON}	$I_{BSTSW} = 200mA$		0.73	0.8	Ω
SW Leakage Current	I_{BSTSW_LKG}	$V_{BSTSW} = 12V$			2	μA
SW Current Limit	I_{BSTSW_LIMIT}	$R_{BSTISET} = 300k\Omega$		180		mA
Schottky Diode Forward Voltage	V_{BSTFW}	$I_{BSTFW} = 100mA$	0.4	0.5	0.6	V
Fixed OUT Supply Voltage	V_{BSTOUT_FD}	Let BSTFB pin floating, $1.8V < V_{BSTIN} < 5.5V$	9.7	10	10.3	V
FB Voltage (Regulation Mode)	V_{BSTFB}	Connect R-divider to BSTFB, $1.8V < V_{BSTIN} < 5.5V$	1.20	1.23	1.26	V
FB Input Bias Current	I_{BSTFB}	$V_{BSTFB} = 1.23V$			1	μA
Output Disconnect Switch On-Resistance	R_{DISC_ON}	$V_{BSTOUT} = 10V$		0.7	0.8	Ω
Thermal Shutdown				150		$^\circ C$
Charger						
Supply Current from V_{IN}	I_{SUPPLY}	$I_{CHG} = 0A$,		0.5		mA
Input UVLO		Input falling	1.8	2.3	2.8	V
Battery Reverse Current to BATT Pin		Input=GND or float, $V_{BAT} = 4V$			2	μA
Battery Voltage Regulation	V_{BATT}	$T_A = 0^\circ C$ to $+50^\circ C$, $I_{CHG} = 5mA$	4.16	4.20	4.24	V
Constant Current Regulation	I_{CHG}	$V_{CHGIN} = 5V$, $V_{BATT} = 3.8V$ $R_{PGM} = 1.6k\Omega$	225	250	275	mA
		$V_{CHGIN} = 5V$, $V_{BATT} = 3.8V$, $R_{PGM} = 1.5k\Omega - 7.2k\Omega$, $-40^\circ C < T_A < +85^\circ C$	90	100	110	$\%I_{CHG(5)}$
Trickle Current		$V_{CHGIN} = 5V$, $V_{BATT} = 2.3V$	5	10	15	$\%I_{CHG}$
Trickle Threshold Voltage		V_{BATT} Rising	2.45	2.6	2.75	V
Trickle Voltage Hysteresis				190		mV
CHGZ Low-to-High Threshold				10		$\%I_{CHG}$
CHGZ Sink Current		Pin Voltage = 0.2 V	5			mA

ELECTRICAL CHARACTERISTICS (continued)

 $V_{BSTIN} = 2.4V$, $V_{BSTOUT} = 10V$, $I_{BSTOUT} = 2mA$, $V_{CHGIN} = V_{LDOIN} = 5V$, $T_A = 25^\circ C$, unless otherwise noted.

Parameters	Symbol	Condition	Min	Typ	Max	Units
Dropout Voltage	$V_{CHGIN} - V_{BATT}$	$V_{BATT} = 3.8V$, $I_{CHG} = 150mA$, Current drop 10%		0.25		V
Overcharge Protection		$V_{BATT} = 4.25V$			0	μA
Thermal Limit ⁽⁶⁾				130		$^\circ C$
LDO						
Operating Voltage		$I_{LDOOUT} = 1mA$	2.7		6.5	V
Ground Pin Current		$I_{LDOOUT} = 1mA - 250mA$		125	155	μA
Shutdown Current		$V_{LDOEN} = 0V$, $V_{LDOIN} = 5V$		0.1	1	μA
FB Regulation Voltage			1.197	1.222	1.246	V
			$-40^\circ C \leq T_A \leq +85^\circ C$	1.194	1.222	
Dropout Voltage ⁽⁷⁾		$V_{LDOOUT} = 3V$, $I_{LDOOUT} = 150mA$ $V_{LDOOUT} = 4V$, $I_{LDOOUT} = 150mA$		150		mV
				125		
Output Voltage Noise		$f = 1kHz$, $C_{LDOFB} > 0.1\mu F$, $I_{LDOOUT} = 1mA$		300		nV/\sqrt{Hz}
Line Regulation		$I_{LDOOUT} = 1mA$, $V_{LDOIN} = (V_{LDOOUT} + 0.5V)$ to $6.5V$ ⁽⁸⁾		0.005		%/V
Load Regulation		$I_{LDOOUT} = 1mA$ to $150mA$, $V_{LDOIN} = V_{LDOOUT} + 0.5V$ ⁽⁸⁾		0.001		%/mA
PSRR		$V_{LDOIN} > V_{LDOOUT} + 0.5V$, $C_{LDOOUT} = 2.2\mu F$, $V_{LDOIN(AC)} = 100mV$, $f = 1kHz$		70		dB
				30		dB
LDOEN Input High Voltage			1.5			V
LDOEN Input Low Voltage					0.4	V
LDOEN Input Bias Current		$V_{LDOEN} = 0V$, $5V$		0.01	1	μA
Thermal Protection				155		$^\circ C$
Thermal Protection Hysteresis				30		$^\circ C$
Control Interface						
BSTEN/SX Input High Voltage	V_{BSTEN_H}		1.4			V
BSTEN/SX Input Low Voltage	V_{BSTEN_L}				0.4	V
BSTEN/SX Input Bias Current	I_{BSTEN}				1	μA

ELECTRICAL CHARACTERISTICS *(continued)*
 $V_{BSTIN} = 2.4V$, $V_{BSTOUT} = 10V$, $I_{BSTOUT} = 2mA$, $V_{CHGIN} = V_{LDOIN} = 5V$, $T_A = 25^\circ C$, unless otherwise noted.

Parameters	Symbol	Condition	Min	Typ	Max	Units
SPDT Switch						
Switch On-Resistance	R_{SPDT_ON}	$V_{BSTOUT} = 10V$, $I_A, I_B, I_C, I_D = 2mA$		25	50	Ω
Switch On-Resistance Match Between Channels	ΔR_{SPDT_ON}	$V_{BSTOUT} = 10V$, $I_A, I_B, I_C, I_D = 2mA$			10	Ω
Turn-on Time	T_{ON}	$R_L = 300\Omega$, $C_L = 35pF$		80		ns
Turn-off Time	T_{OFF}	$R_L = 300\Omega$, $C_L = 35pF$		170		ns
Protection						
Output Disconnect Switch On-Resistance	R_{DISC_ON}	$V_{BSTOUT} = 10V$		0.74	0.8	Ω
Thermal Shutdown				150		$^\circ C$

Notes:

- 5) I_{CHG} is the target preprogrammed charge current (Die temperature below $110^\circ C$).
- 6) Guarantee by design
- 7) Dropout Voltage is defined as the input to output differential when the output voltage drops 1% below its normal value
- 8) $V_{LDOIN} = 2.7V$ for $V_{LDOOUT} = 1.25V$ to $2.2V$.

TYPICAL PERFORMANCE CHARACTERISTICS

Step-Up Converter

$V_{BSTIN} = V_{BSTEN} = 2.4V$, $V_{BSTOUT} = 10V$, $I_{BSTOUT} = 2mA$, $L1 = 10\mu H/150m\Omega$, unless otherwise noted.

Efficiency

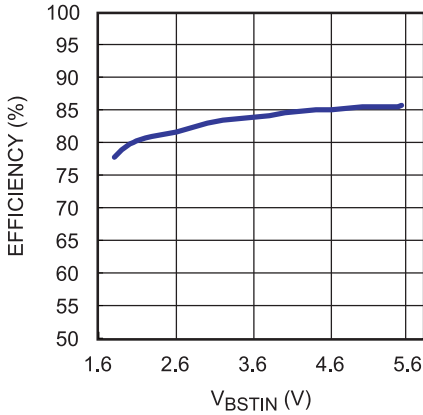

V_{BSTIN} vs. Current Limit

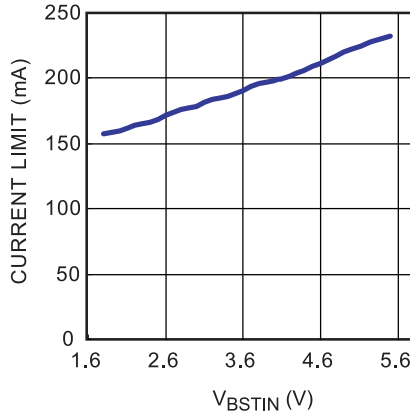

R_{BSTISET} vs. Current Limit

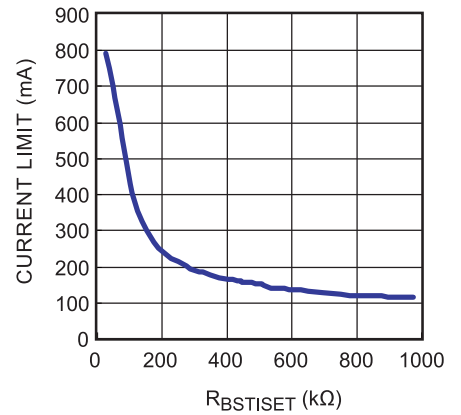

Steady State Waveforms

V_{BSTIN}=2V

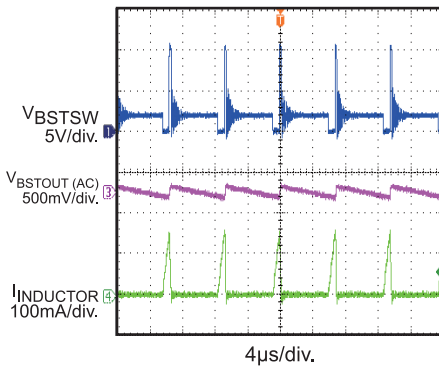

Steady State Waveforms

V_{BSTIN}=4.2V

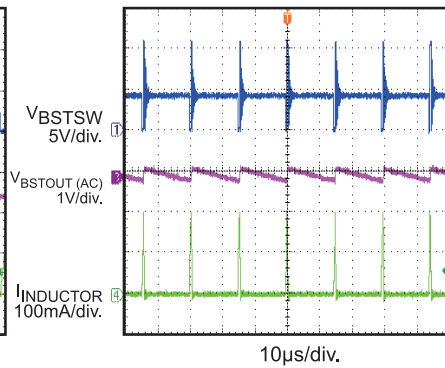

V_{BSTIN} Power On

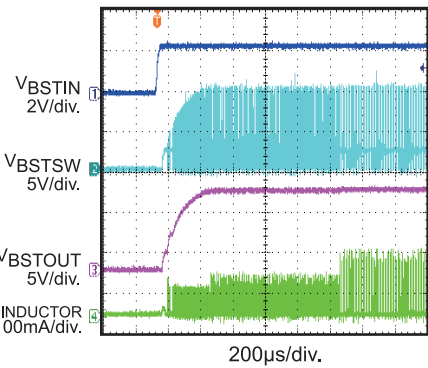

V_{BSTIN} Power Off

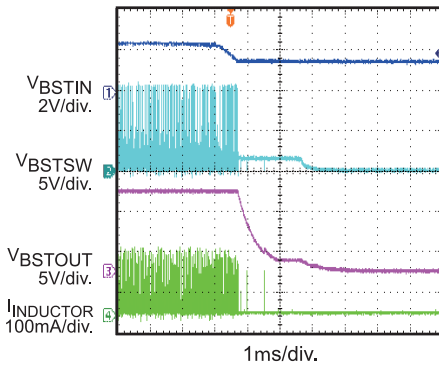

V_{BSTEN} Power On

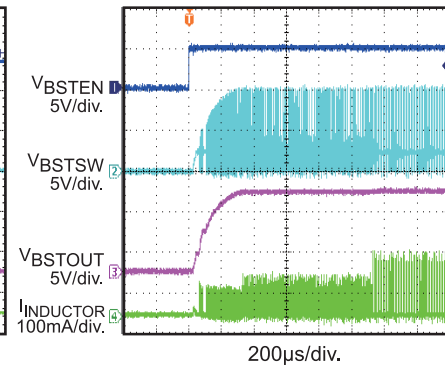

V_{BSTEN} Power Off

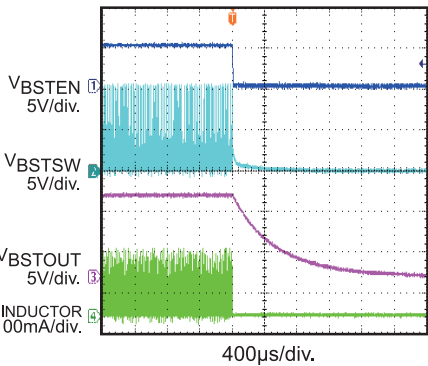

TYPICAL PERFORMANCE CHARACTERISTICS (Continued)

Charger

$V_{CHGIN} = 5V$, $C3 = C5 = 1\mu F$, $T_A = 25^\circ C$, unless otherwise noted.

Battery Charge Curve

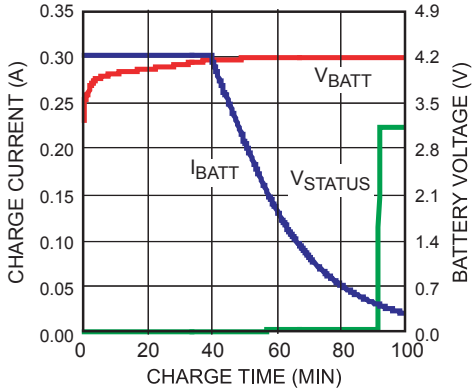

Charge Current vs. Battery Voltage

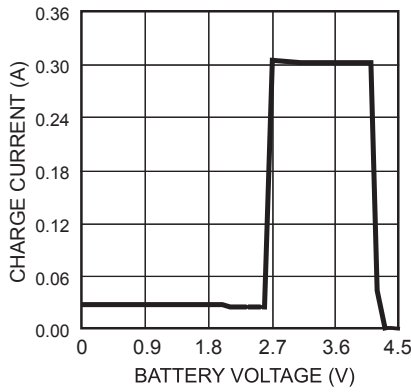

Battery Voltage vs. Input Voltage

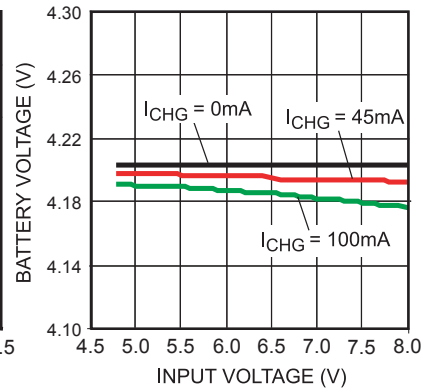

Charge Current vs. Battery Voltage

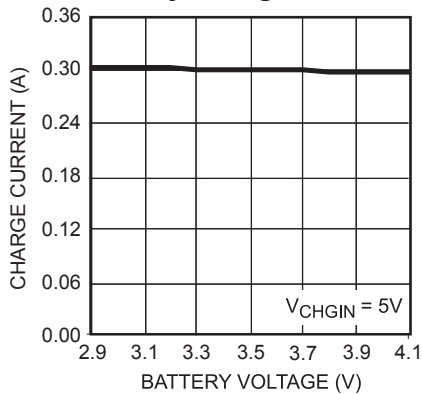

Charge Current vs. Input Voltage

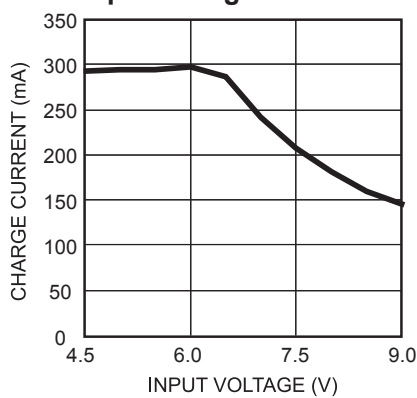

Charge Current vs. RpGM Resistance

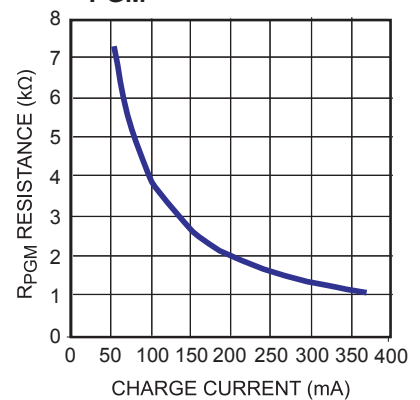

Forward Leakage Current

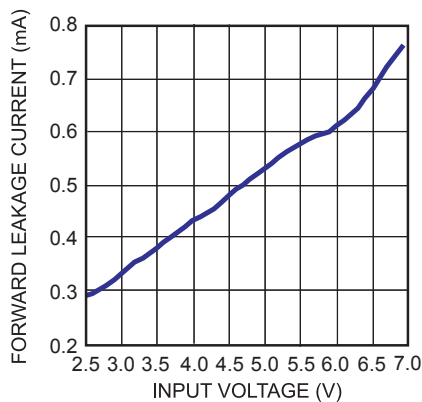

Reverse Current vs. Battery Voltage

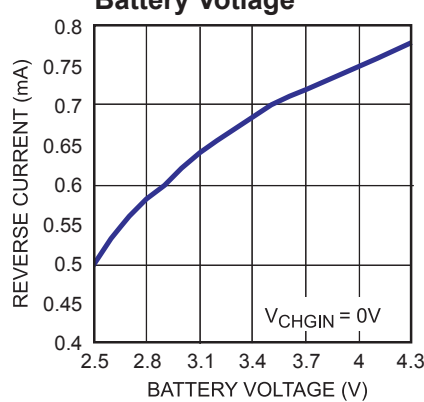

Charge Current vs. Temperature

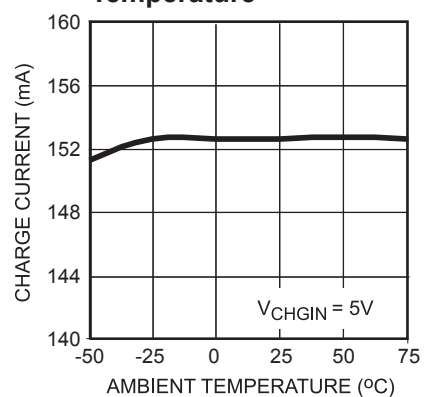

TYPICAL PERFORMANCE CHARACTERISTICS (Continued)

Charger

$V_{CHGIN} = 5V$, $C3 = C5 = 1\mu F$, $T_A = 25^\circ C$, unless otherwise noted.

Battery Voltage vs. Temperature

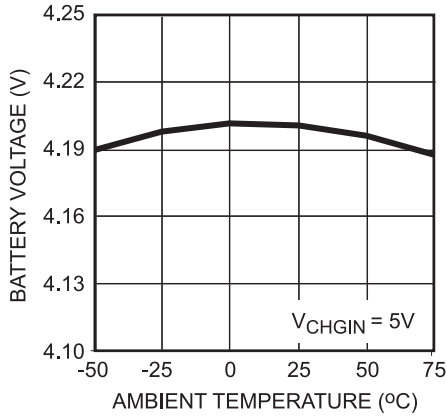

Power-On

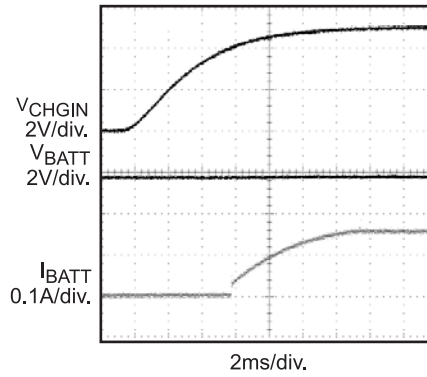

Power-Off

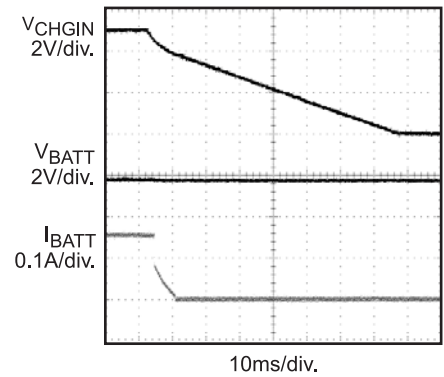

TYPICAL PERFORMANCE CHARACTERISTICS (Continued)

LDO

$V_{LDOIN} = 4.5V$, $V_{LDOOUT} = 2.85V$, $C4 = 1\mu F$, $C_{BYP} = 0.1\mu F$, $C6 = 2.2\mu F$, $T_A = 25^\circ C$, unless otherwise noted.

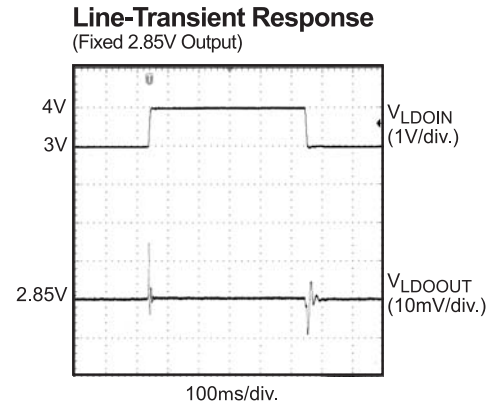
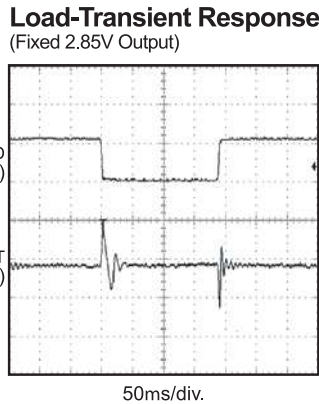
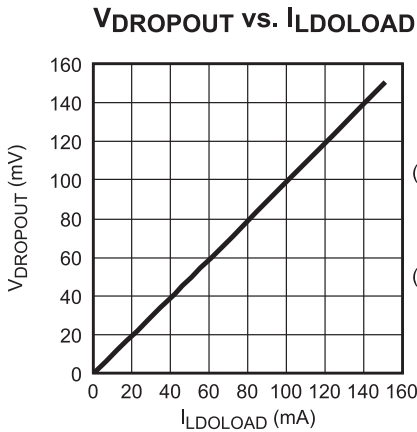
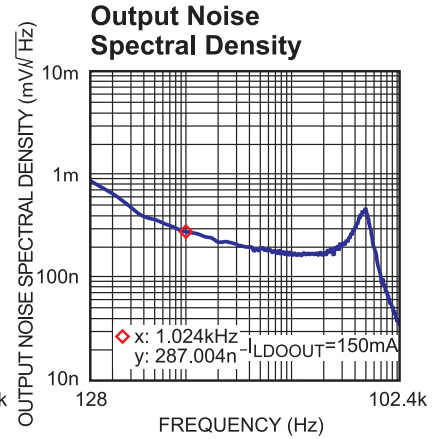
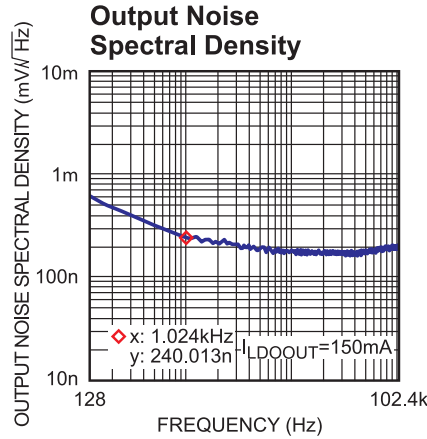
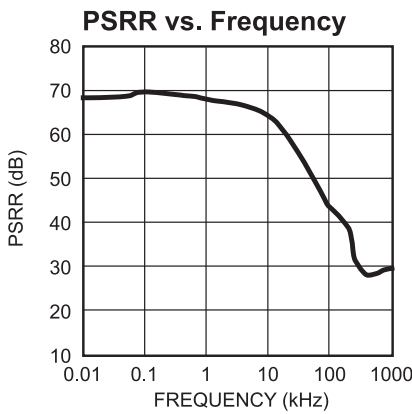
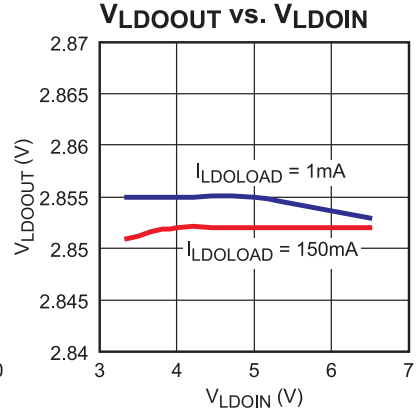
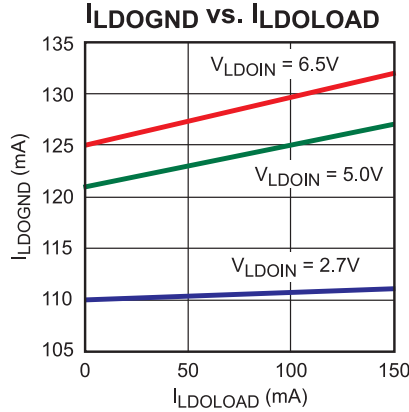
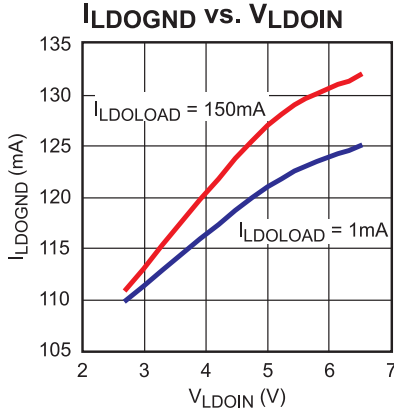

TYPICAL PERFORMANCE CHARACTERISTICS (Continued)

SPDT Switch

$V_{BSTIN} = V_{BSTEN} = 2.4V$, $V_{BSTOUT} = 10V$, $I_{BSTOUT} = 2mA$, $L1 = 10\mu H/150m\Omega$, unless otherwise noted.

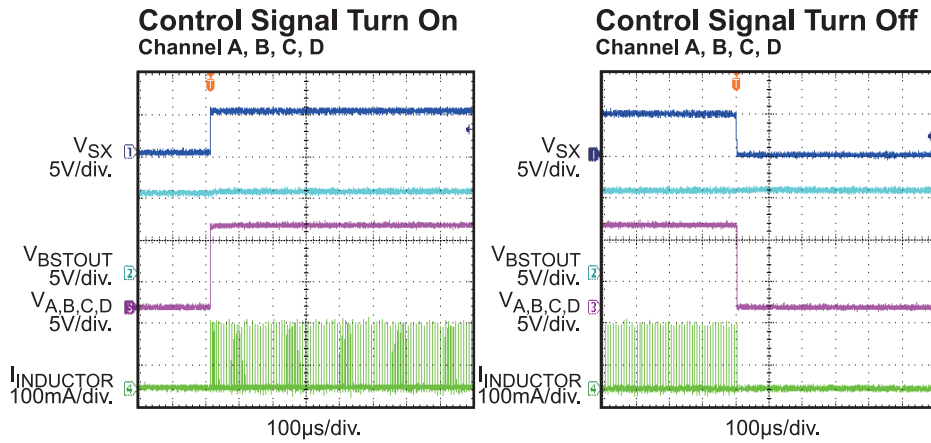

PIN FUNCTIONS

Pin #	Name	Pin Function
1	S2	C-Channel SPDT Switch Control Input. If the chip is enabled, a logic low input switches C to GND and a logic high input switches C to BSTOUT. Do not leave this pin floating.
2	BSTFB	Step-Up Converter Regulator Feedback. Connect to the tap of an external resistor divider from the output to BSTFB to set the boost converter output voltage. Float this pin to achieve fixed 10V output.
3	BSTISET	Step-Up Converter Constant Peak Current Set. Connect to an external resistor to BSTGND to set the boost converter peak current.
4	BSTGND	Step-Up Converter and SPDT Ground.
5	BATT	Charger Output.
6	IPGM	Constant-Charge–Current Programmer. Connect to an external resistor to ground to program the charging current in constant-current mode. Do not connect a capacitor to this pin.
7, 9	CHGGND	Charger Ground.
8	CHGIN	Charger Input Supply. CHGIN receives the AC adapter.
10	CHGZ	Open-Drain Charger Status Indicator.
11	LDOEN	Low Dropout Enabled. Drive LDOEN high to turn on the low dropout, drive LDOEN low to turn it off. For automatic startup, connect LDOEN to LDOIN.
12	LDOIN	Low Dropout Power Source Input. LDOIN supplies the internal power to the low dropout and is the source of the pass transistor. Bypass LDOIN to LDOGND with a 1 μ F or greater capacitor.
13	LDOGND	Low Dropout Ground.
14, 15	LDOOUT	Low Dropout Regulator Output. LDOOUT is the output of the linear regulator. Bypass LDOOUT to LDOGND with a 1 μ F or greater capacitor.
16	LDOFB	Low Dropout Feedback Input. Connect a resistor divider from LDOOUT to LDOFB to set the output voltage.
17	BSTSW	Step-Up Converter Output Switch Node. BSTSW is the drain node of the internal low-side N-Channel MOSFET. Connect the inductor from BSTL to BSTSW to complete the step-up converter.
18	BSTOUT	Step-Up Converter Output.
19	BSTIN	Step-Up Converter and SPDT Input Supply. BSTIN pin powers the internal circuitry and is the drain of the internal disconnecting N-channel MOSFET. Bypass locally.
20	BSTL	Step-Up Converter Inductor Output. BSTL is the source/body of the internal N-channel MOSFET, M3. Connect the inductor from this pin to BSTSW.
21	BSTEN	Step-Up Converter and SPDT On/Off Control Input. A logic high input turns the chip on.. Do not leave this pin floating.
22	S1	B-Channel SPDT Switch Control Input. If the chip is enabled, a logic low input switches B to GND and a logic high input switches B to BSTOUT. Do not leave this pin floating.
23	S0	A-Channel SPDT Switch Control Input. If the chip is enabled, a logic low input switches A to GND and a logic high input switches A to BSTOUT. Do not leave this pin floating.

PIN FUNCTIONS *(continued)*

Pin #	Name	Pin Function
24	A	A-Channel SPDT Switch Output.
25	B	B-Channel SPDT Switch Output.
26	C	C-Channel SPDT Switch Output.
27	D	D-Channel SPDT Switch Output.
28	S3	D-Channel SPDT Switch Control Input. If the chip is enabled, a logic low input switches D to GND and a logic high input switches D to BSTOUT. Do not leave this pin floating.
	Exposed Pad	Connect exposed pad to ground plane in PCB for proper thermal performance.

FUNCTIONAL BLOCK DIAGRAM

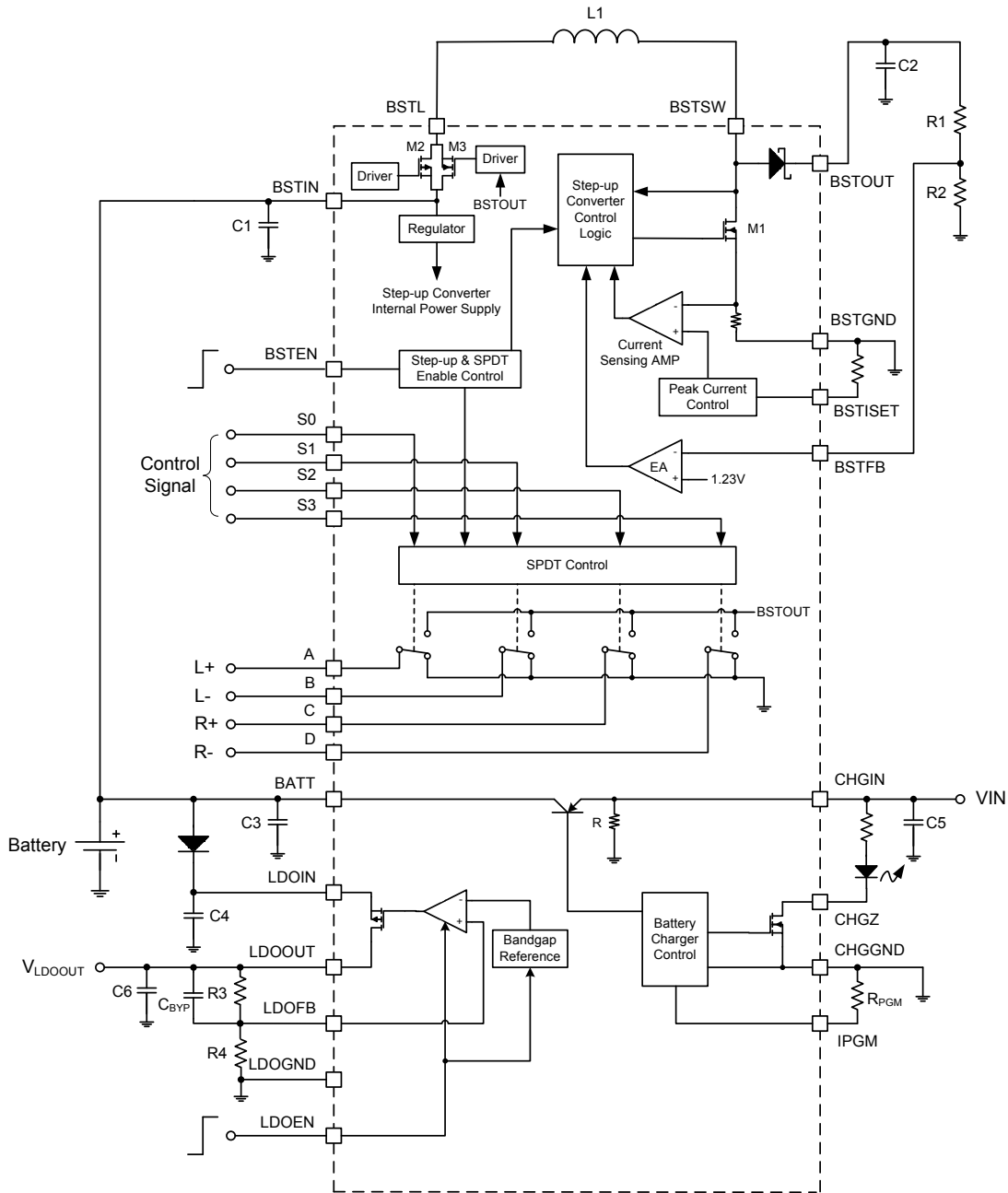

Figure 1—Functional Block Diagram

OPERATION

The MP5414 is a high-efficiency fully-integrated PMU with a current-mode step-up converter, four single-pole/double-throw (SPDT) switches, low dropout (LDO), and a battery charger designed for low-power battery-operated bias-supply applications.

Step-Up Converter

Output Disconnection

The step-up converter integrates a disconnect switch between the BSTIN and the BSTL pins. The switch is composed of an NMOS and a PMOS in parallel. The step-up converter can disconnect all loads from input DC power supply when the BSTEN pin is connected to ground.

Under Voltage Lockout

An under-voltage lockout (UVLO) function prevents device startup for values of $V_{BATT} < 1.5V$. If V_{BSTIN} falls below 1.5V during device operation and battery discharge, the device automatically enters the shutdown mode.

Step-Up Converter Start-Up

The converter undergoes the following steps after first applying the input signal and followed by the enable signal:

1. PMOS of the disconnect switch turns on,
2. Internal soft-start boosts step-up converter, causing V_{BSTOUT} to rise,
3. V_{BSTOUT} drives the NMOS of the disconnect switch when V_{BSTOUT} reaches threshold.

Because the on-resistance of the NMOS is smaller than that of PMOS, the NMOS shorts the PMOS under normal operation to reduce conduction loss.

The MP5414 offers both soft-start and inrush current limiting during start-up and under normal operation.

Soft-Start

The step-up converter implements a soft-start by charging an internal capacitor with a very weak current source. The voltage on this capacitor, in turn, slowly ramps the peak inductor current limit from zero to the setting value. The step-up

converter limits this inrush current by increasing the current limit in three steps, rising from 0A to $I_{LIM}/4$ in 256 switching cycles, then $I_{LIM}/4$ to $I_{LIM}/2$ for the next 256 cycles, before rising to the full current limit. The soft-start time varies greatly with load current; output voltage, and input voltage.

Variable Frequency

Constant-Peak-Current Operation

When the power MOSFET M1 is turned on, the inductor current increases until it hits its current limit. The power MOSFET then turns off for a set minimum-off time. If the feedback pin is still lower than the 1.23V internal reference at the end of this minimum off time, the power MOSFET will turn on again. Otherwise the step-up converter waits until the voltage drops below the threshold before turning on the MOSFET again. This process allows for optimal use of the inductor while minimizing the output ripple, reducing the size of the output capacitor, and maintaining low operating current.

Integrated Schottky Diode

A high switching frequency requires high-speed rectification for optimum efficiency. The step-up converter integrates a low-voltage-drop schottky diode to reduce the number of external parts to save critical board space.

Four SPDT Switches

The MP5414 includes four SPDT analog switches, where pins S0 through S3 control the switches, respectively. While the chip is enabled, a logic-low input switches the corresponding channel output to BSTGND. Conversely, a logic-high input switches the channel to BSTOUT. Table 1 shows the control logic.

Table 1—Switching Selection Control Logic

BSTEN	Control Input				Switch Output			
	S0	S1	S2	S3	A	B	C	D
L	X	X	X	X	Open	Open	Open	Open
H	L	L	L	L	BSTGND	BSTGND	BSTGND	BSTGND
H	H	L	L	L	BSTOUT	BSTGND	BSTGND	BSTGND
H	L	H	L	L	BSTGND	BSTOUT	BSTGND	BSTGND
H	H	H	L	L	BSTOUT	BSTOUT	BSTGND	BSTGND
H	L	L	H	L	BSTGND	BSTGND	BSTOUT	BSTGND
H	H	L	H	L	BSTOUT	BSTGND	BSTOUT	BSTGND
H	L	H	H	L	BSTGND	BSTOUT	BSTOUT	BSTGND
H	H	H	H	L	BSTOUT	BSTOUT	BSTOUT	BSTGND
H	L	L	L	H	BSTGND	BSTGND	BSTGND	BSTOUT
H	H	L	L	H	BSTOUT	BSTGND	BSTGND	BSTOUT
H	L	H	L	H	BSTGND	BSTOUT	BSTGND	BSTOUT
H	H	H	L	H	BSTOUT	BSTOUT	BSTGND	BSTOUT
H	L	L	H	H	BSTGND	BSTGND	BSTOUT	BSTOUT
H	H	L	H	H	BSTOUT	BSTGND	BSTOUT	BSTOUT
H	L	H	H	H	BSTGND	BSTOUT	BSTOUT	BSTOUT
H	H	H	H	H	BSTOUT	BSTOUT	BSTOUT	BSTOUT

H: High Level L: Low Level X: Irrelevant

Charger

The charger is enabled when the input supply voltage reaches 3.5V, the UVLO threshold, or the battery voltage—whichever voltage is highest. An internal 500kΩ pull-down resistor connects the CHGIN and CHGGND pins. The charger automatically switches between CC/CV charging algorithms depending on the battery status. Figure 2 shows a typical charging sequence.

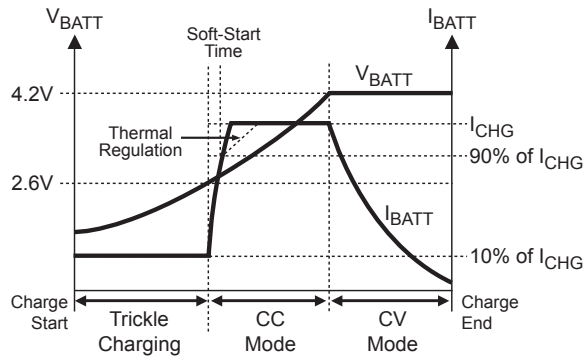

Figure 2—Charger Typical Charging Procedure

Programming of Charge Current and Battery Full Current

Table 2—R_{PGM} and I_{CHG} Relationship

R _{PGM} (kΩ)	I _{CHG} (mA)
7.210	54.67
5.555	70.99
4.010	98.70
3.742	105.90
2.497	159.80
1.873	214.30
1.492	269.90
1.249	323.00
1.080	371.00

A resistor (R_{PGM}) connecting the IPGM pin to ground programs the charge current, I_{CHG}. Table 2 and Figure 3 show the relationship between the charge current and the value of the programming resistor.

When the battery voltage falls below the trickle-charge threshold (2.6V), the charge current is limited to 10% of the programmed value. After the battery voltage reaches 2.6V, the charger switches to constant-current (CC) mode using a

programmed current value, I_{CHG}. Once the battery voltage reaches 4.2V, the charger will operate in the Constant Voltage (CV) mode until the battery is fully charged.

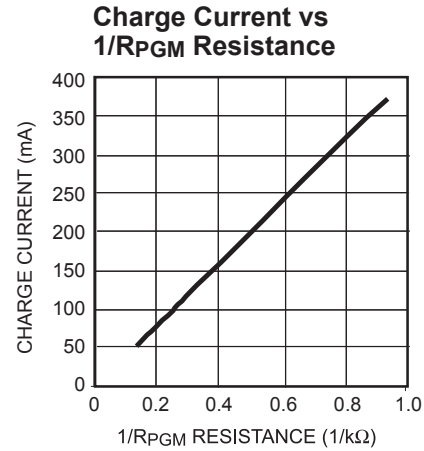

Figure 3—Charge Current vs. 1/R_{PGM} Resistance

Charge Status (CHGZ)

The open-drain CHGZ pin monitors charge status by connecting to V_{BATT} through an LED, a resistor, or both. The CHGZ pin signals the end-of-charge—or battery full—when its voltage goes from LOW to HIGH (i.e. the LED turns off), which occurs when I_{CHG} decreases to 10% of the programmed value.

Thermal Protection

The charger automatically limits the die temperature to 130°C by reducing the current to prevent overheating. The current remains continuous throughout.

LDO

The MP5414 has an integrated low-current, low-noise, high-PSRR, low-dropout linear regulator. It is suitable for use in devices that require very low noise power supplies and high-PSRR such as PLL VCO supplies for mobile handsets and 802.11 PC Cards, as well as audio codecs and microphones. The LDO uses a PMOS pass element and features internal thermal shutdown. An optional feed-forward capacitor C_{BYP} between LDOFB and LDOOUT pins for improves transient response.

APPLICATION INFORMATION

Components referenced below apply to Typical Application Circuit on page 2.

Setting the Step-Up Converter BSTSW Current Limit

The resistor on the BSTISET pin sets the BSTSW current limit. Figure 4 illustrates the relationship of the BSTSW current limit vs. the BSTISET resistor. In constant-peak-current mode, the inductor current increases until the current limit is reached after the power MOSFET turns on. Since the response delay, the actual BSTSW peak current value exceeds the setting current limit a little. Under same condition, a lower current limit allows lower BSTSW current and higher switching frequency, while a higher current limit allows higher BSTSW current and lower switching frequency.

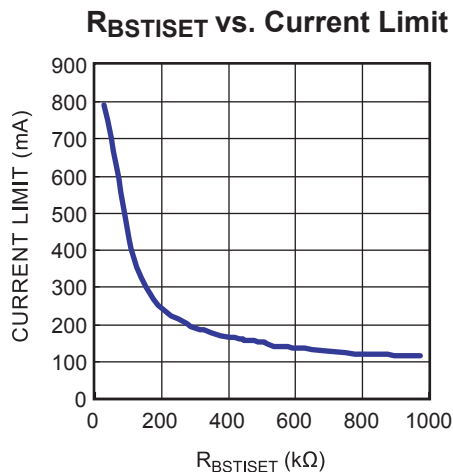

Figure 4—BSTISET Resistance vs. BSTSW Current Limit

Setting the BSTOUT Output Voltage

MP5414's step-up converter features an internal resistor divider that allows the device to output a fixed 10V when the BSTFB is left floating. Connecting the BSTFB pin to the tap of an external resistor divider between BSTOUT to ground otherwise sets the boost converter output voltage, where:

$$V_{\text{BSTOUT}} = V_{\text{BSTFB}} \times \frac{R1 + R2}{R2}$$

Where $V_{\text{BSTFB}} = 1.23\text{V}$.

For example, if $R1=178\text{k}\Omega$ and $R2 = 24.9\text{k}\Omega$, then $V_{\text{BSTOUT}} = 10\text{V}$.

Selecting the Step-Up Converter Inductor

Select an inductor with a DC current rating of at least 40% higher than the maximum input current. For best efficiency, select an inductor with the lowest-possible DC resistance.

Selecting the Step-Up Converter Input Capacitor

The input capacitor, C1, reduces both the surge current drawn from the input supply and the switching noise from the device. Select a capacitor with a switching frequency impedance less than the input source impedance to prevent high-frequency switching current from passing through the input: for example, ceramic capacitors with X5R or X7R dielectrics with low ESR and small temperature coefficients. A $4.7\mu\text{F}$ or $10\mu\text{F}$ capacitor will suffice for most applications.

Selecting the Step-Up Converter Output Capacitor

The output capacitor, C2, limits the output voltage and improves feedback loop stability. Select an output capacitor with a low switching frequency impedance, such as ceramic capacitors with X7R dielectrics with low ESR characteristics. A ceramic capacitor with a value of less than $10\mu\text{F}$ will suffice for most applications.

Flow Chart of Charger Operation

The power-on reset (POR) feature can ensure that the device initiates in a known state. The flow chart in Figure 5 describes the conditions that lead to charger operation modes, such as constant voltage charge (CVC) and constant-current charge (CCC).

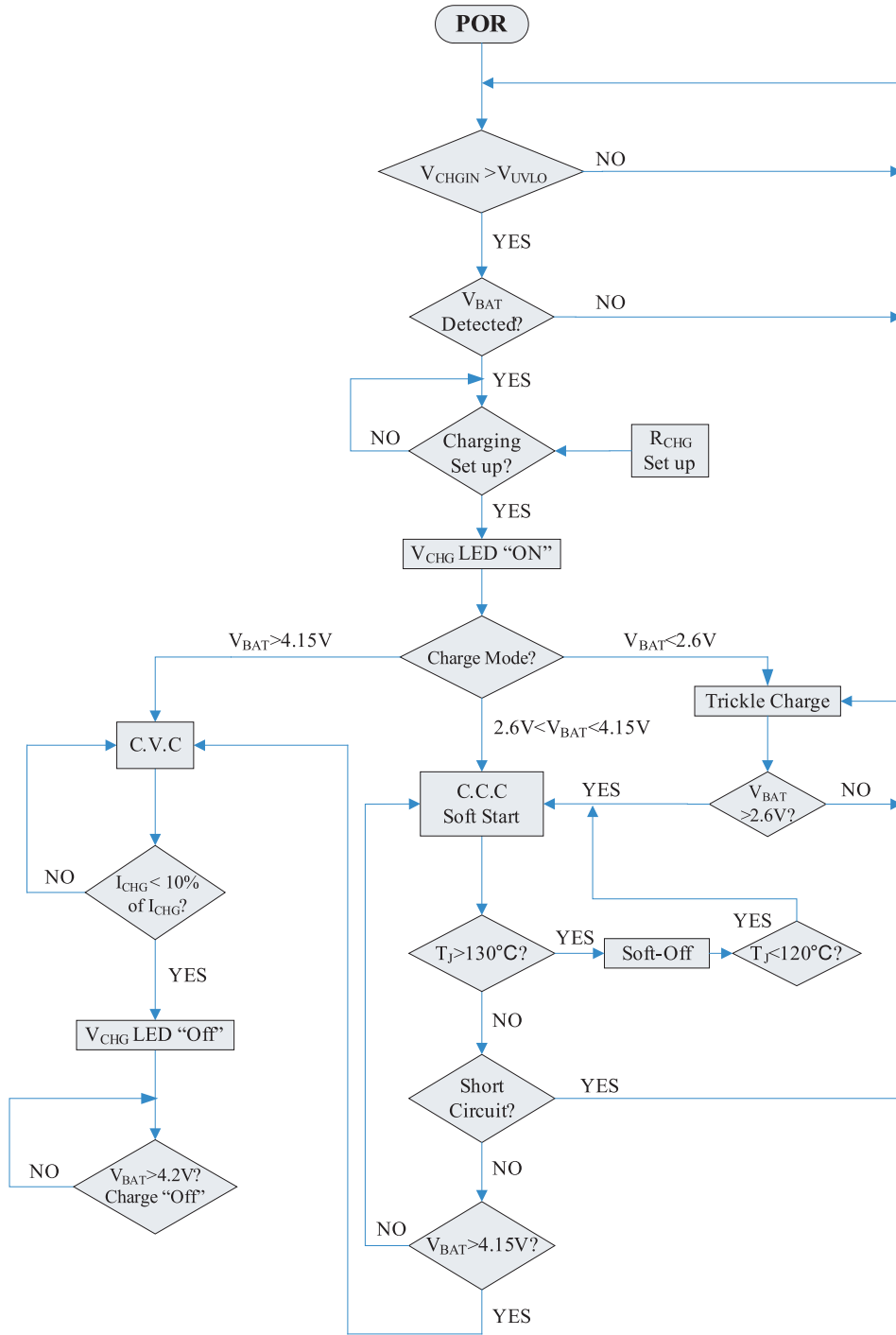

Figure 5—Flow Chart of Charger Operation

Setting the LDO Output Voltage

The LDO output voltage can be also adjusted by using an external resistor divider (R3 and R4 in the Functional Block Diagram). However, the value of R3 and R4 in series should not exceed 100kΩ to minimize the impact on the internal resistor divider. To accurately set the output voltage, use 10kΩ (±1%) for the low-side resistor (R4), and determine the value of the high-side resistor R3 using the following equation:

$$R3 = R4 \times \left(\frac{V_{LDOOUT} - V_{LDOFB}}{V_{LDOFB}} \right)$$

Where V_{LDOFB} is the OUT feedback threshold voltage equal to 1.222V.

For example, for a 2.5V output

$$R3 = \frac{2.5V - 1.222V}{\left(\frac{1.222V}{10k\Omega} \right)} = 10.41k\Omega$$

You can select a standard 10.5kΩ (±1%) resistor for R3.

The following table lists the selected standard R3 values for correlated with their output voltages:

Table 3—Adjustable LDO Output Voltage R3 Values

V _{LDOOUT} (V)	R3 (Ω)	R4 (Ω)
1.25	232	10k
1.5	2.26k	
1.8	4.75k	
2	6.34k	
2.5	10.5k	
2.8	13k	
3	14.7k	
3.3	16.9k	
4	22.6k	
5	30.9k	

Selecting the LDO Input Capacitor

For proper operation, place a ceramic capacitor (C4) between 1μF and 10μF of dielectric type X5R or X7R between the LDOIN pin and ground. Larger values in this range will help improve line transient response at the cost of increased size.

Selecting the LDO Output Capacitor

For stable operation, use a ceramic capacitor of type X5R or X7R between 1μF and 10μF for the LDOOUT capacitor, C6. Larger values in this range will help improve load transient response and reduce noise at the cost of increased size. Other dielectric types can be used, but their temperature-sensitivity can unduly influence their capacitances.

To improve load transient response, add a small ceramic (X5R, X7R or Y5V dielectric) 100nF feed-forward capacitor in parallel with R3. The feed-forward capacitor is not required for stable operation.

Layout Considerations

Proper layout of the high frequency switching path is critical to limit noise issues and electromagnetic interference. The circuit loop from BSTOUT pin, output capacitor to BSTGND pin is flowing with high frequency pulse current. It must be as short as possible. The BSTIN pin is the power supply input for the internal MOSFET switch gate driver and the internal control circuitry and requires decoupling. For the LDO, the input and output need bypass ceramic capacitors close to the LDOIN pin and LDOOUT pin respectively. Ensure all feedback connections are short and direct. Place the feedback resistors and compensation components as close to the chip as possible. Connect LDOIN, LDOOUT and especially LDOGND respectively to a large copper area to cool the chip to improve thermal performance and long-term reliability. See the MP5414 demo board layout for reference.

PACKAGE INFORMATION

QFN28 (4x5mm)

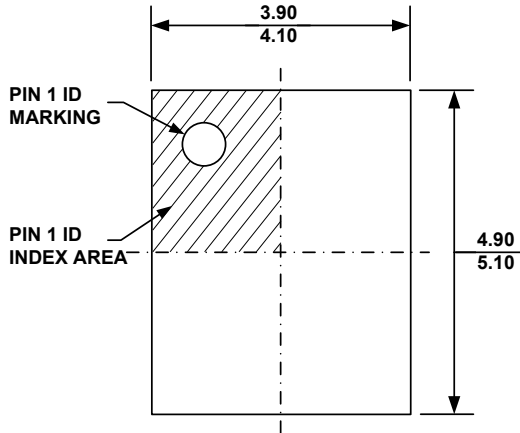

TOP VIEW

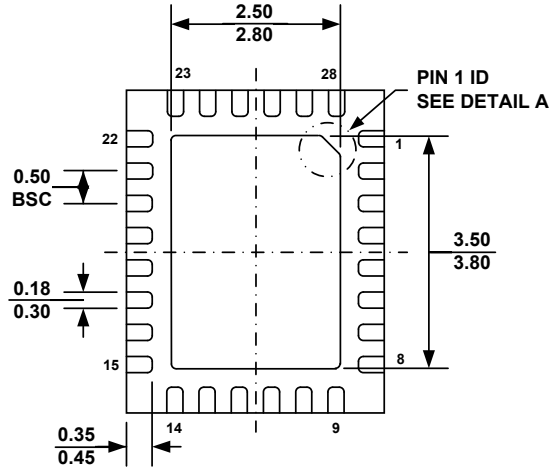

BOTTOM VIEW

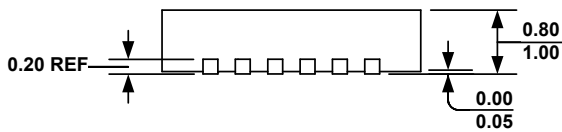

SIDE VIEW

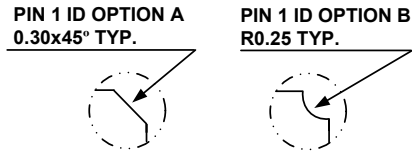

DETAIL A

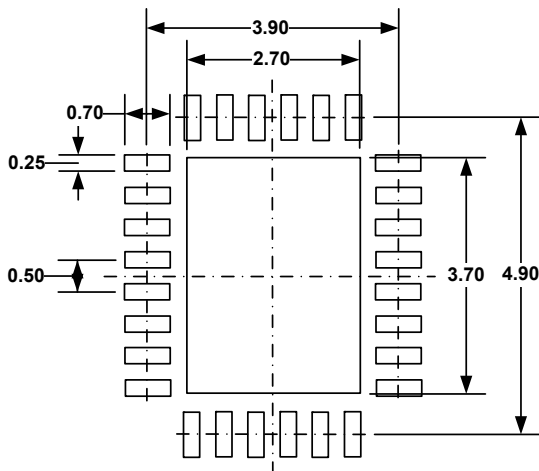

RECOMMENDED LAND PATTERN

NOTE:

- 1) ALL DIMENSIONS ARE IN MILLIMETERS.
- 2) EXPOSED PADDLE SIZE DOES NOT INCLUDE MOLD FLASH.
- 3) LEAD COPLANARITY SHALL BE 0.10 MILLIMETER MAX.
- 4) DRAWING CONFORMS TO JEDEC MO-220, VARIATION VGHD-3.
- 5) DRAWING IS NOT TO SCALE.

NOTICE: The information in this document is subject to change without notice. Users should warrant and guarantee that third party Intellectual Property rights are not infringed upon when integrating MPS products into any application. MPS will not assume any legal responsibility for any said applications.