



Chipsmall Limited consists of a professional team with an average of over 10 year of expertise in the distribution of electronic components. Based in Hongkong, we have already established firm and mutual-benefit business relationships with customers from,Europe,America and south Asia,supplying obsolete and hard-to-find components to meet their specific needs.

With the principle of “Quality Parts,Customers Priority,Honest Operation,and Considerate Service”,our business mainly focus on the distribution of electronic components. Line cards we deal with include Microchip,ALPS,ROHM,Xilinx,Pulse,ON,Everlight and Freescale. Main products comprise IC,Modules,Potentiometer,IC Socket,Relay,Connector.Our parts cover such applications as commercial,industrial, and automotives areas.

We are looking forward to setting up business relationship with you and hope to provide you with the best service and solution. Let us make a better world for our industry!



Contact us

Tel: +86-755-8981 8866 Fax: +86-755-8427 6832

Email & Skype: info@chipsmall.com Web: www.chipsmall.com

Address: A1208, Overseas Decoration Building, #122 Zhenhua RD., Futian, Shenzhen, China



DESCRIPTION

The MP62180/MP62181 Power Distribution Switch features internal current limiting to prevent damage to host devices due to faulty load conditions. The MP62180/MP62181 operates from a 3.3V or 5V nominal input voltage and includes an 85mΩ Power MOSFET to handle up to 2A continuous load with a 2.8A typical current limit. The MP62180/MP62181 has built-in protection for both over current and increased thermal stress. For over-current protection (OCP), the device will limit the current by going into a constant current mode.

When continuous output overload condition exceeds power dissipation of the package, the thermal protection will shut the part off. The device will recover once the device temperature reduces to approx 120°C.

The MP62180/MP62181 is available in QFN8E, MSOP8E and SOIC8 packages.

FEATURES

- 2A Continuous Current
- 2.8A accurate Current Limit
- 2.7V to 5.5V Supply Range
- 90uA Quiescent Current
- 75mΩ MOSFET
- Thermal-Shutdown Protection
- Under-Voltage Lockout
- 8ms FLAG Deglitch Time
- No FLAG Glitch During Power Up
- Reverse Current Blocking
- Active High & Active Low Options

APPLICATIONS

- Smartphone and PDA
- Portable GPS Device
- Notebook PC
- Set-top-box
- Telecom and Network Systems
- PC Card Hot Swap
- USB Power Distribution

"MPS" and "The Future of Analog IC Technology" are Registered Trademarks of Monolithic Power Systems, Inc.

TYPICAL APPLICATION

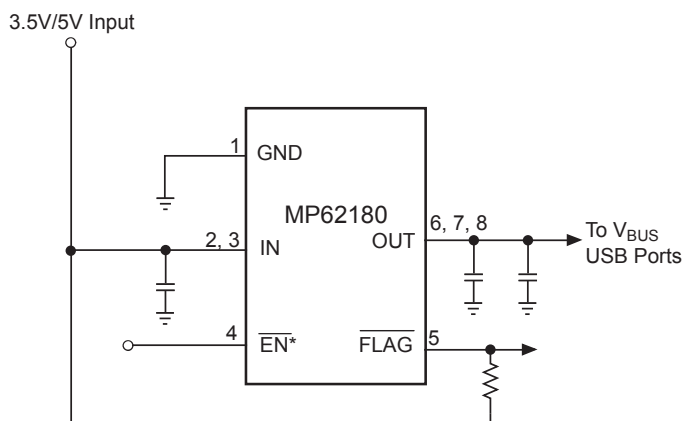

SINGLE-CHANNEL
 * EN is active high for MP62181

ORDERING INFORMATION

| Part Number | Enable | Switch | Maximum Continuous Load Current | Typical Short-Circuit Current @ T _A =25°C | Package | Top Marking | Free Air Temperature (T _A) |
|-------------|-------------|--------|---------------------------------|--|-------------------|-------------|--|
| MP62180DS | Active Low | Single | 2A | 2.8A | SOIC8 | 62180DS | -40°C to +85°C |
| MP62180DD | | | | | QFN8E (2mm x 3mm) | 62180DD | |
| MP62180DH | | | | | MSOP8E | 62180DH | |
| MP62181DS | Active High | | | | SOIC8 | 62181DS | |
| MP62181DD | | | | | QFN8E (2mm x 3mm) | 62181DD | |
| MP62181DH | | | | | MSOP8E | 62181DH | |

* For Tape & Reel, add suffix -Z (e.g. MP62180DH-Z).

For RoHS Compliant Packaging, add suffix -LF (e.g. MP62180DH-L)

PACKAGE REFERENCE

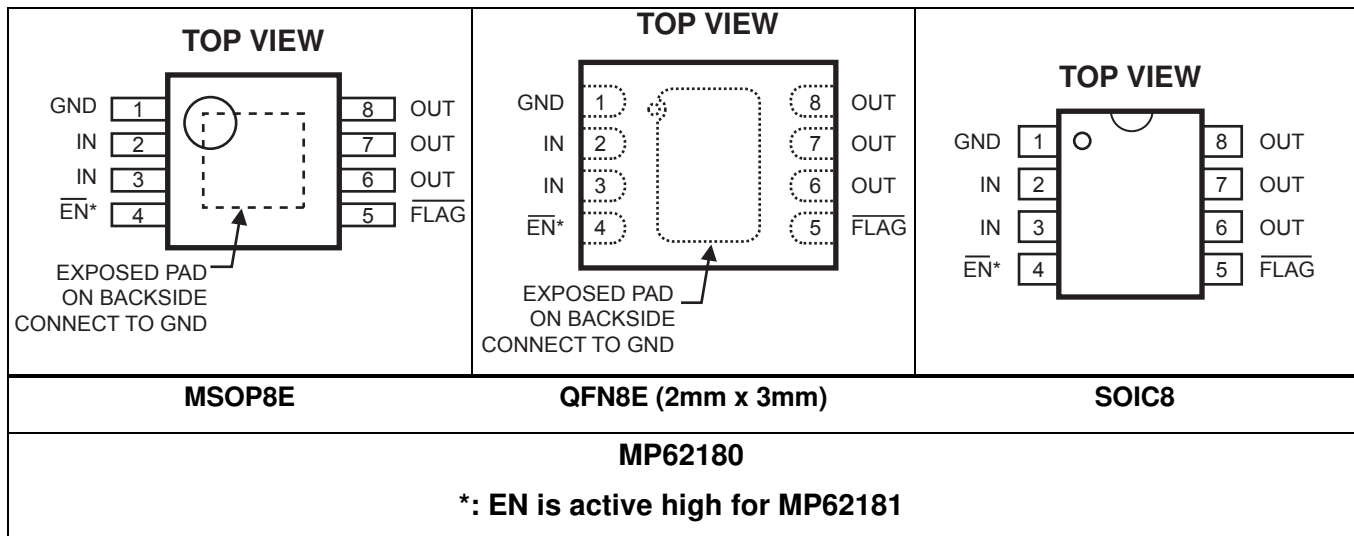

ABSOLUTE MAXIMUM RATINGS ⁽¹⁾

| | |
|--|-----------------|
| IN | -0.3V to +6.0V |
| EN, FLAG, OUT to GND | -0.3V to +6.0V |
| Continuous Power Dissipation (T _A = +25°C) ⁽²⁾ | |
| MSOP8E | 2.3W |
| QFN8E (2mm x 3mm) | 2.3W |
| SOIC8 | 1.4W |
| Junction Temperature | 150°C |
| Lead Temperature | 260°C |
| Storage Temperature | -65°C to +150°C |
| Operating Temperature | -40°C to +85°C |

| <i>Thermal Resistance</i> ⁽³⁾ | θ_{JA} | θ_{JC} |
|--|---------------|---------------|
| MSOP8E | 55 | 12... °C/W |
| QFN8E (2mm x 3mm) | 55 | 12... °C/W |
| SOIC8 | 90 | 42... °C/W |

Notes:

- 1) Exceeding these ratings may damage the device.
- 2) The maximum allowable power dissipation is a function of the maximum junction temperature T_J(MAX), the junction-to-ambient thermal resistance θ_{JA} , and the ambient temperature T_A. The maximum allowable continuous power dissipation at any ambient temperature is calculated by P_D(MAX)=(T_J(MAX)-T_A)/ θ_{JA} . Exceeding the maximum allowable power dissipation will cause excessive die temperature, and the regulator will go into thermal shutdown. Internal thermal shutdown circuitry protects the device from permanent damage.
- 3) Measured on JESD51-7, 4-layer PCB.

ELECTRICAL CHARACTERISTICS ⁽⁴⁾
 $V_{IN}=5V$, $T_A=+25^{\circ}C$, unless otherwise noted.

| Parameter | Condition | Min | Typ | Max | Units | |
|--|--|----------------------|-----|------|-------------|------------|
| IN Voltage Range | | 2.7 | | 5.5 | V | |
| Supply Current | Device Active, $I_{OUT}=0$ | | 90 | 120 | μA | |
| Shutdown Current | Device Disable, $V_{OUT}=\text{float}$, $V_{IN}=5.5V$ | | 1 | | μA | |
| Off Switch Leakage | Device Disable, $V_{IN}=5.5V$ | | 1 | | μA | |
| Current Limit | | 2.1 | 2.8 | 3.5 | A | |
| Trip Current | Current Ramp (slew rate $\leq 100A/s$) on Output | | 3.1 | 4 | A | |
| Under-voltage Lockout | Rising Edge | 1.95 | | 2.65 | V | |
| Under-voltage Hysteresis | | | 250 | | mV | |
| FET On Resistance | $I_{OUT}=100mA$ ($-40^{\circ}C \leq T_A \leq 85^{\circ}C$) | MSOP8E | | 75 | 120 | m Ω |
| | | QFN8E (2mm x 3mm) | | 75 | 120 | m Ω |
| | | SOIC8 | | 85 | 130 | m Ω |
| EN Input Logic High Voltage | | 2 | | | V | |
| EN Input Logic Low Voltage | | | | 0.8 | V | |
| FLAG Output Logic Low Voltage | $I_{SINK}=5mA$ | | | 0.4 | V | |
| FLAG Output High Leakage Current | $V_{IN}=V_{FLAG}=5.5V$ | | | 1 | μA | |
| Thermal Shutdown | | | 140 | | $^{\circ}C$ | |
| Thermal Shutdown Hysteresis | | | 20 | | $^{\circ}C$ | |
| V_{OUT} Rising Time, T_r ⁽⁵⁾ | $V_{IN}=5.5V$, $C_L=1\mu F$, $R_L=5\Omega$ | | 0.9 | | ms | |
| | $V_{IN}=2.7V$, $C_L=1\mu F$, $R_L=5\Omega$ | | 1.7 | | ms | |
| V_{OUT} Falling Time, T_f ⁽⁶⁾ | $V_{IN}=5.5V$, $C_L=1\mu F$, $R_L=5\Omega$ | | | 0.5 | ms | |
| | $V_{IN}=2.7V$, $C_L=1\mu F$, $R_L=5\Omega$ | | | 0.5 | ms | |
| Turn On Time, T_{on} ⁽⁷⁾ | $C_L=100\mu F$, $R_L=5\Omega$ | | | 3 | ms | |
| Turn Off Time, T_{off} ⁽⁸⁾ | $C_L=100\mu F$, $R_L=5\Omega$ | | | 10 | ms | |
| FLAG Deglitch Time | | 4 | 8 | 15 | ms | |
| EN Input Leakage | | -1 | | | μA | |
| Reverse Leakage Current | OUT=5.5V, IN=GND | | 0.2 | | μA | |

NOTE:

- 4) Production test at $+25^{\circ}C$. Specifications over the temperature range are guaranteed by design and characterization.
- 5) Measured from 10% to 90%.
- 6) Measured from 90% to 10%.
- 7) Measured from (50%) EN signal to (90%) output signal.
- 8) Measured from (50%) EN signal to (10%) output signal.

PIN FUNCTIONS

| Pin # SOIC8 | Pin # MSOP8E | Pin # QFN8E | Name | Description |
|----------------|-----------------|----------------|--------------------------|---|
| 1 | 1 | 1 | GND | Ground. |
| 2, 3 | 2, 3 | 2, 3 | IN | Input Voltage. Accepts 2.7V to 5.5V input. |
| 4 | 4 | 4 | $\overline{\text{EN}}$ | Active Low: (MP62180), Active High: (MP62181) |
| 5 | 5 | 5 | $\overline{\text{FLAG}}$ | IN-to-OUT Over-current, active-low output flag. Open-Drain. |
| 6, 7, 8 | 6, 7, 8 | 6, 7, 8 | OUT | IN-to-OUT Power-Distribution Output (for all 3 output pins) |

TYPICAL PERFORMANCE CHARACTERISTICS

$T_A = +25^\circ\text{C}$, unless otherwise noted.

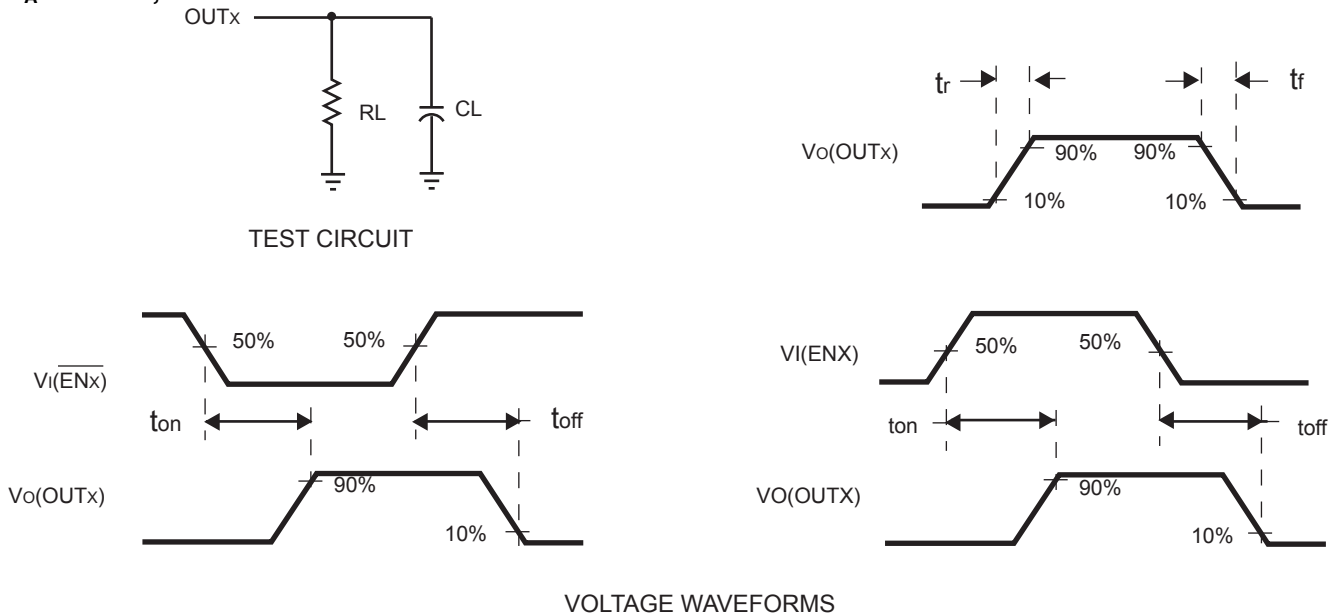
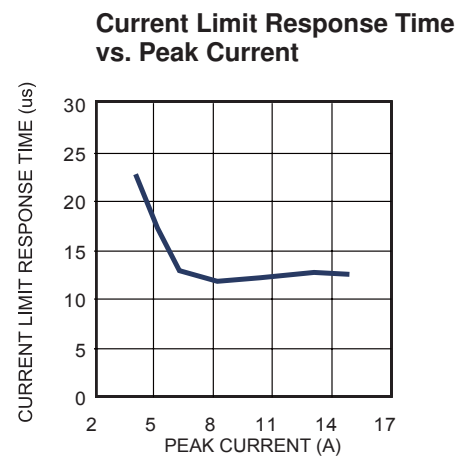
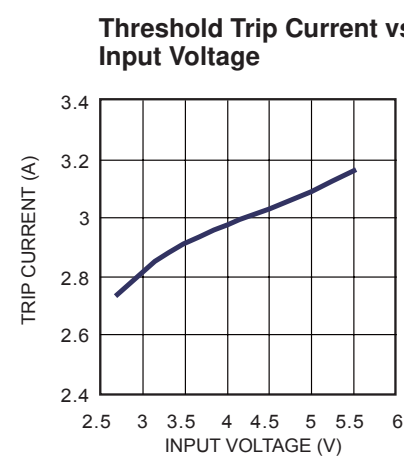
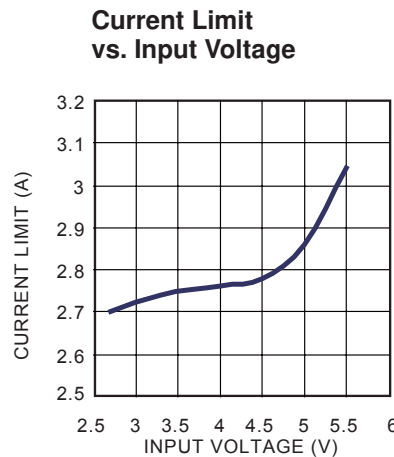
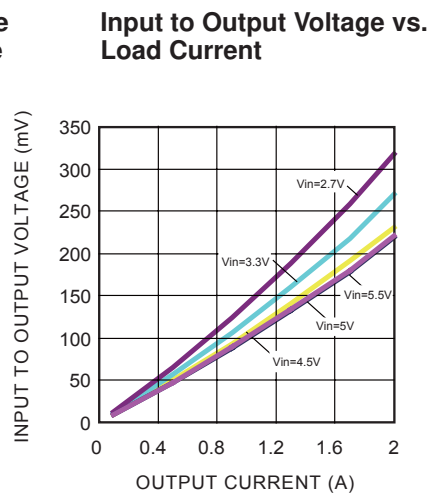
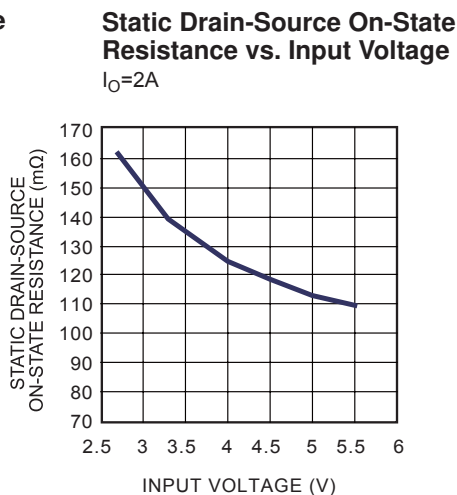
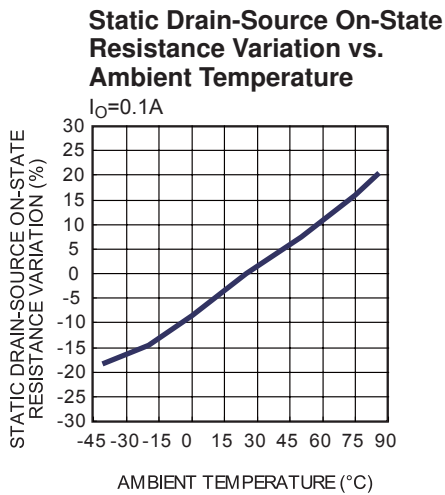
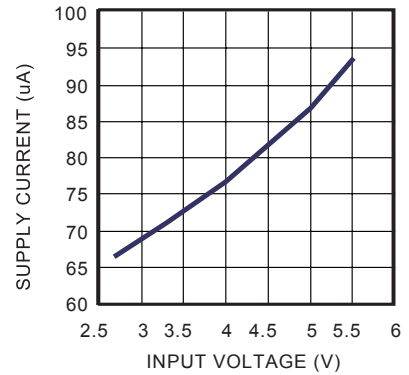
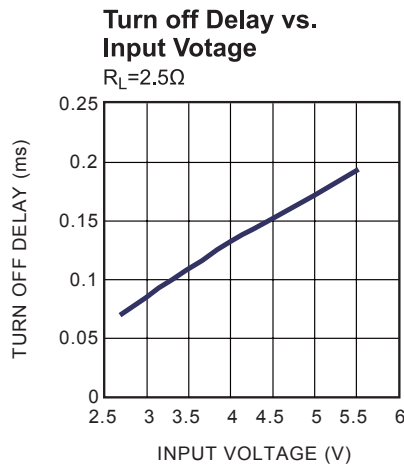
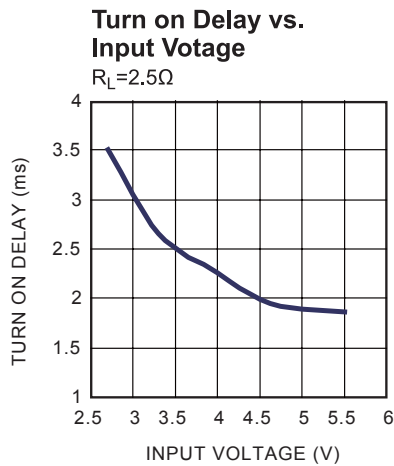

Figure 1—Test Circuit and Voltage Waveforms

TYPICAL PERFORMANCE CHARACTERISTICS

$V_{IN} = 5V$, $V_{EN} = 0V$ for MP62180 or 5V for MP62181, $C_L = 2.2\mu F$, $T_A = +25^\circ C$, unless otherwise noted.
Supply Current, Output Enabled vs. Input Voltage



TYPICAL PERFORMANCE CHARACTERISTICS *(continued)*

$V_{IN} = 5V$, $V_{EN} = 0V$ for MP62180 or $5V$ for MP62181, $C_L = 2.2\mu F$, $T_A = +25^\circ C$, unless otherwise noted.

Turn On Delay and Rise Time with 0.22 μF Load
 $C_L = 0.22\mu F$

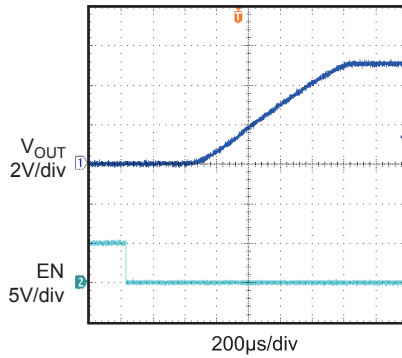

Turn Off Delay and Fall Time with 0.22 μF Load
 $C_L = 0.22\mu F$

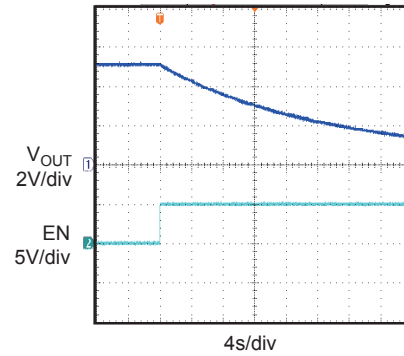

Turn On Delay and Rise Time with 2.2 μF Load
 $R_L = 2.5\Omega$

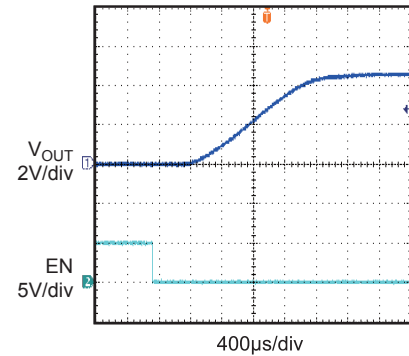

Turn Off Delay and Fall Time with 2.2 μF Load
 $R_L = 2.5\Omega$

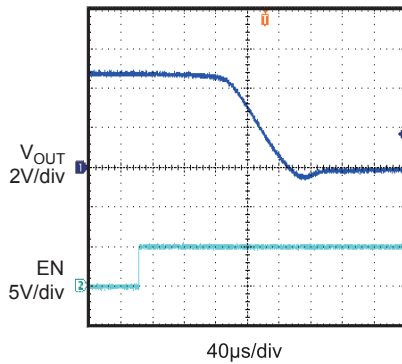

Short Circuit Current, Device Enabled into Short

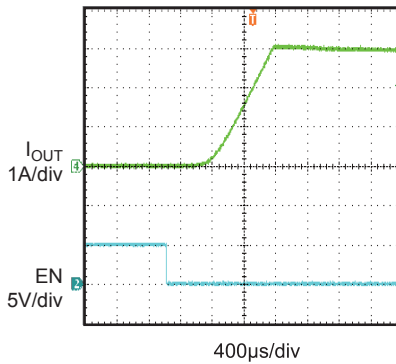

Threshold Trip Current with Ramped Load on Enabled Device

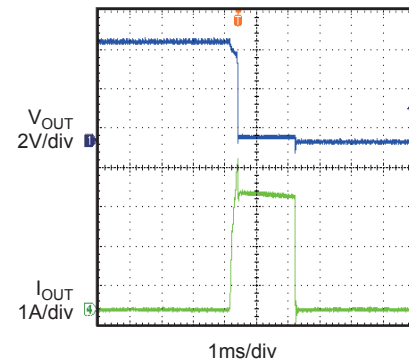

Ramped Load on Enabled Device

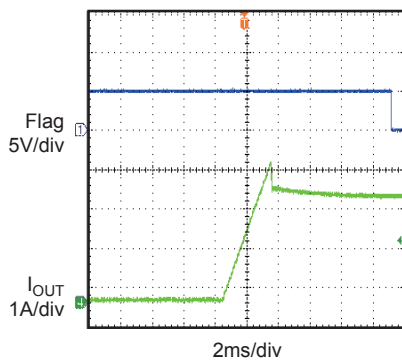

Inrush Current with Different Load Capacitance
 $R_L = 2.5\Omega$

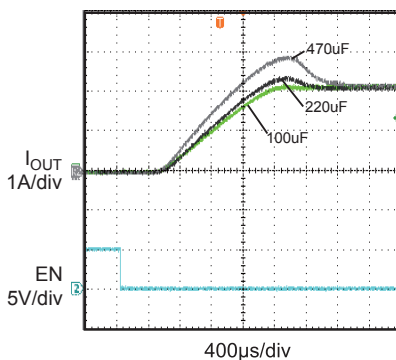

1 Ω Load Connected to Enabled Device

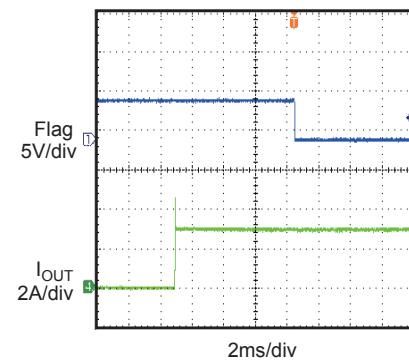

FUNCTION BLOCK DIAGRAM

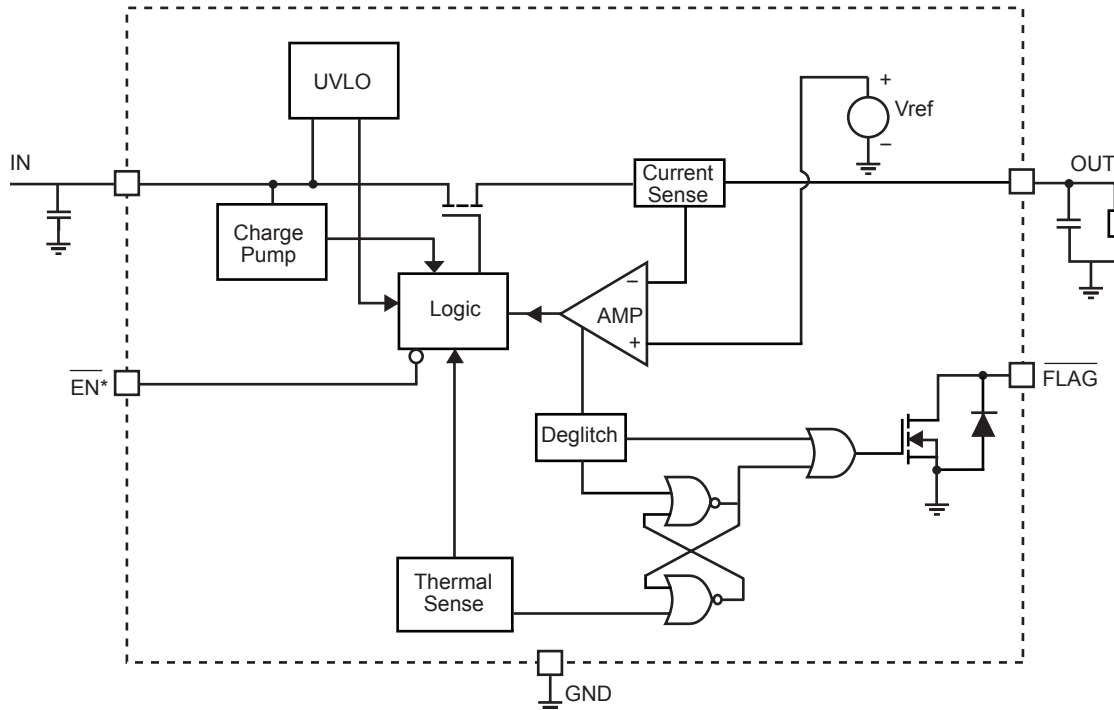

*: EN is active high for MP62181; EN is active low for MP62180

Figure2—Function Block Diagram

DETAILED DESCRIPTION

Over Current

When the load exceeds trip current (minimum threshold current triggering constant-current mode) or a short is present, MP62180/MP62181 switches into to a constant-current mode (current limit value). MP62180/MP62181 will be shutdown only if the overcurrent condition stays long enough to trigger thermal protection.

Trigger overcurrent protection for different overload conditions occurring in applications:

- 1) The output has been shorted or overloaded before the device is enabled or input applied. MP62180/MP62181 detects the short or overload and immediately switches into a constant-current mode.
- 2) A short or an overload occurs after the device is enabled. After the current-limit circuit has been tripped (reached the trip current threshold), the device switches into constant-current mode. However, high current may

flow for a short period of time before the current-limit circuit can react.

- 3) Output current has been gradually increased beyond the recommended operating current. The load current rises until the trip current threshold is reached or until the thermal limit of the device is exceeded. The MP62180/MP62181 is capable of delivering current up to the trip current threshold without damaging the device. Once the trip threshold has been reached, the device switches into its constant-current mode.

Flag Response

The FLAG pin is an open drain configuration. This FAULT will report a fail mode after an 8ms deglitch timeout. This is used to ensure that no false fault signals are reported. This internal deglitch circuit eliminates the need for extend components. The FLAG pin is not deglitched during an over temp. or a voltage lockout.

Thermal Protection

The purpose of thermal protection is to prevent damage in the IC by allowing excessive current to flow and heating the junction. The die temperature is internally monitored until the thermal limit is reached. Once this temperature is reached, the switch will turn off and allow the chip to cool. The switch has a built-in hysteresis.

Under-voltage Lockout (UVLO)

This circuit is used to monitor the input voltage to ensure that the MP62180/MP62181 is operating correctly.

This UVLO circuit also ensures that there is no operation until the input voltage reaches the minimum spec.

Enable

The logic pin disables the switch to reduce overall supply current. Once the EN pin reaches logic enable threshold, the MP62180/MP62181 is enabled.

APPLICATION INFORMATION

Power-Supply Considerations

Over 10 μ F capacitor between IN and GND is recommended. This precaution reduces power-supply transients that may cause ringing on the input and improves the immunity of the device to short-circuit transients.

In order to achieve smaller output load transient ripple, placing a high-value electrolytic capacitor on the output pin(s) is recommended when the load is heavy.

PACKAGE INFORMATION

MSOP8E (EXPOSED PAD)

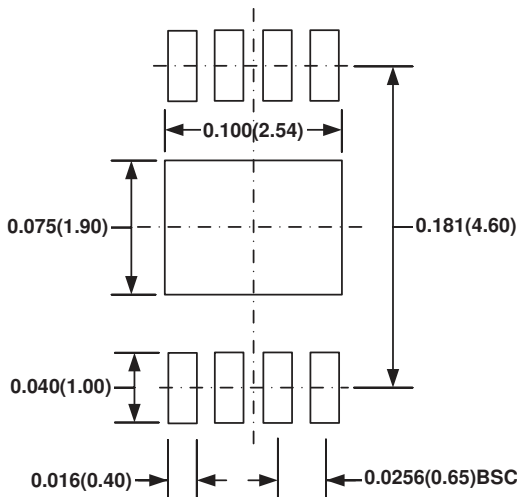
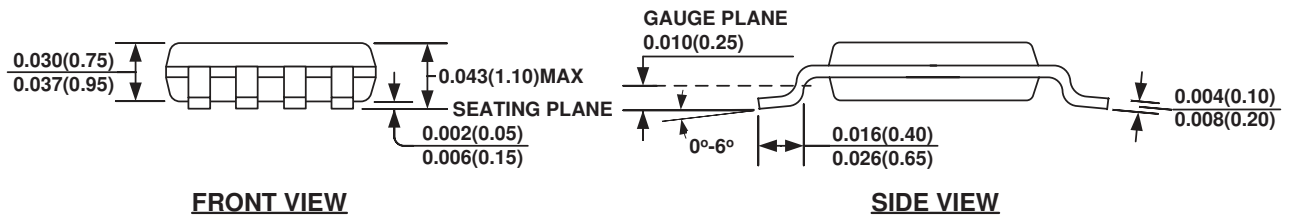
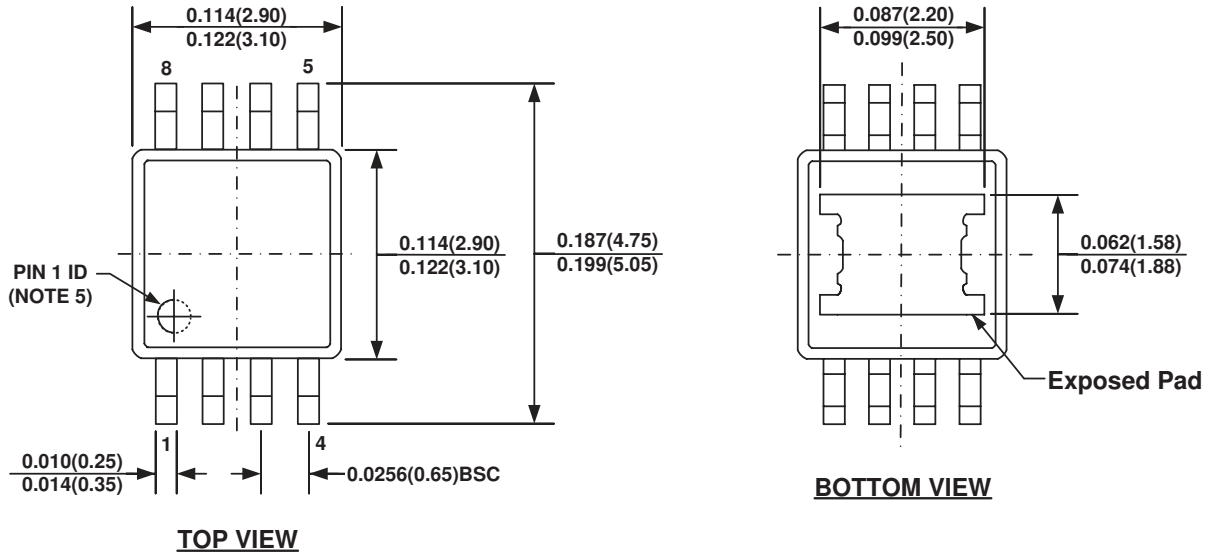

NOTE:

- 1) CONTROL DIMENSION IS IN INCHES. DIMENSION IN BRACKET IS IN MILLIMETERS.
- 2) PACKAGE LENGTH DOES NOT INCLUDE MOLD FLASH, PROTRUSION OR GATE BURR.
- 3) PACKAGE WIDTH DOES NOT INCLUDE INTERLEAD FLASH OR PROTRUSION.
- 4) LEAD COPLANARITY (BOTTOM OF LEADS AFTER FORMING) SHALL BE 0.004" INCHES MAX.
- 5) PIN 1 IDENTIFICATION HAS HALF OR FULL CIRCLE OPTION.
- 6) DRAWING MEETS JEDEC MO-187, VARIATION AA-T.
- 7) DRAWING IS NOT TO SCALE.

QFN8E (2mm x 3mm)

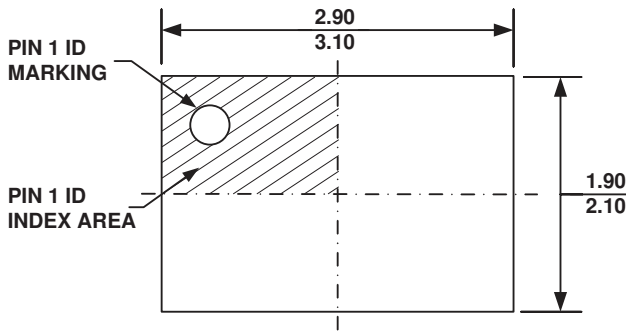

TOP VIEW

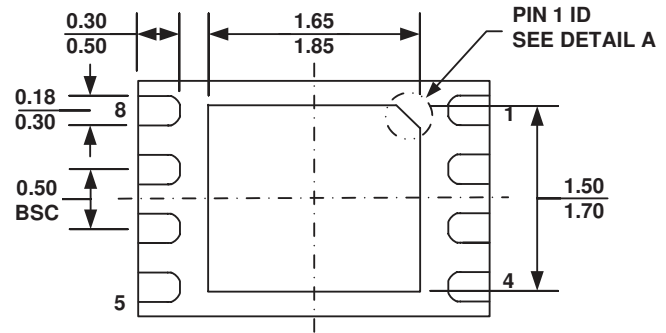

BOTTOM VIEW

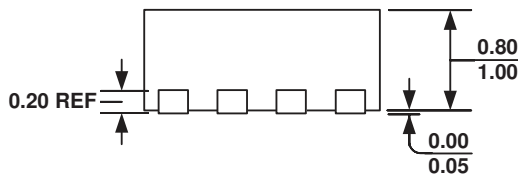

SIDE VIEW

PIN 1 ID OPTION A
0.30x45° TYP.

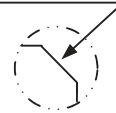

PIN 1 ID OPTION B
R0.20 TYP.

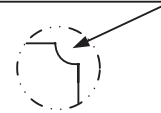

DETAIL A

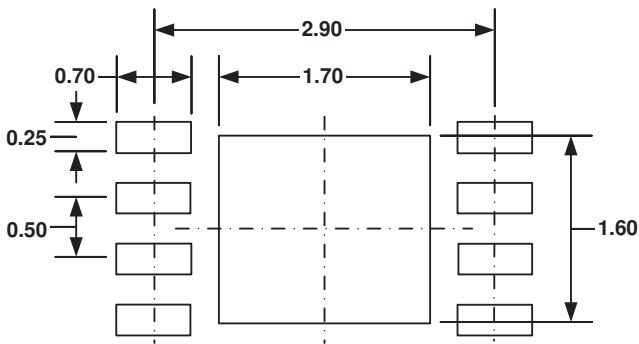

RECOMMENDED LAND PATTERN

NOTE:

- 1) ALL DIMENSIONS ARE IN MILLIMETERS.
- 2) EXPOSED PADDLE SIZE DOES NOT INCLUDE MOLD FLASH.
- 3) LEAD COPLANARITY SHALL BE 0.10 MILLIMETER MAX.
- 4) DRAWING CONFORMS TO JEDEC MO-229, VARIATION VCED-2.
- 5) DRAWING IS NOT TO SCALE.

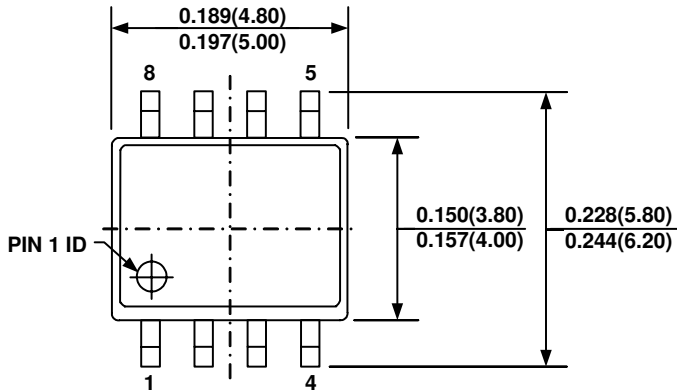
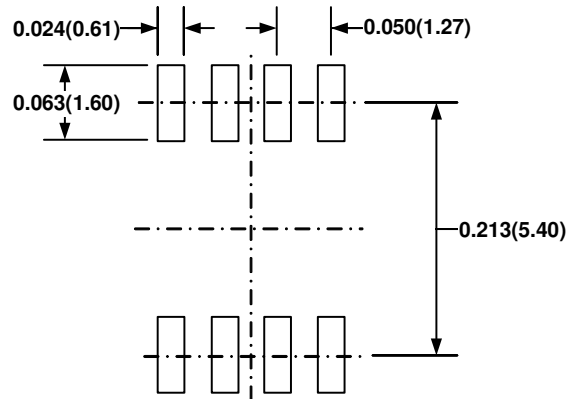
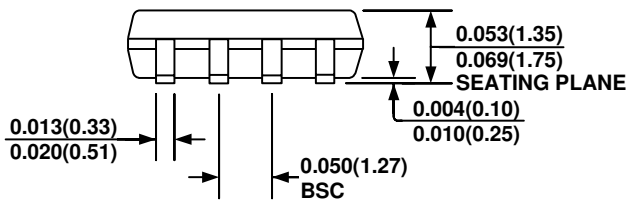
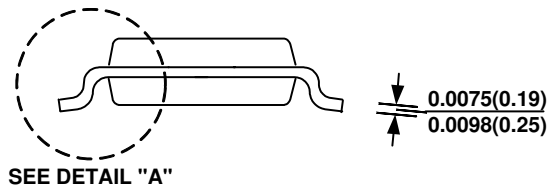
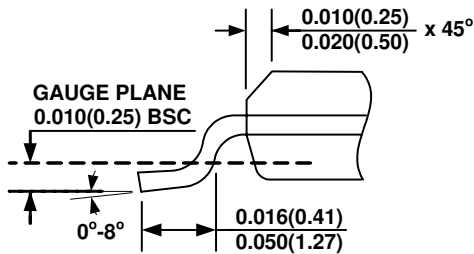
SOIC8

TOP VIEW

RECOMMENDED LAND PATTERN

FRONT VIEW

SIDE VIEW

DETAIL "A"
NOTE:

- 1) CONTROL DIMENSION IS IN INCHES. DIMENSION IN BRACKET IS IN MILLIMETERS.
- 2) PACKAGE LENGTH DOES NOT INCLUDE MOLD FLASH, PROTRUSIONS OR GATE BURRS.
- 3) PACKAGE WIDTH DOES NOT INCLUDE INTERLEAD FLASH OR PROTRUSIONS.
- 4) LEAD COPLANARITY (BOTTOM OF LEADS AFTER FORMING) SHALL BE 0.004" INCHES MAX.
- 5) DRAWING CONFORMS TO JEDEC MS-012, VARIATION AA.
- 6) DRAWING IS NOT TO SCALE.

NOTICE: The information in this document is subject to change without notice. Users should warrant and guarantee that third party Intellectual Property rights are not infringed upon when integrating MPS products into any application. MPS will not assume any legal responsibility for any said applications.