



Chipsmall Limited consists of a professional team with an average of over 10 year of expertise in the distribution of electronic components. Based in Hongkong, we have already established firm and mutual-benefit business relationships with customers from,Europe,America and south Asia,supplying obsolete and hard-to-find components to meet their specific needs.

With the principle of "Quality Parts,Customers Priority,Honest Operation,and Considerate Service",our business mainly focus on the distribution of electronic components. Line cards we deal with include Microchip,ALPS,ROHM,Xilinx,Pulse,ON,Everlight and Freescale. Main products comprise IC,Modules,Potentiometer,IC Socket,Relay,Connector.Our parts cover such applications as commercial,industrial, and automotives areas.

We are looking forward to setting up business relationship with you and hope to provide you with the best service and solution. Let us make a better world for our industry!



Contact us

Tel: +86-755-8981 8866 Fax: +86-755-8427 6832

Email & Skype: info@chipsmall.com Web: www.chipsmall.com

Address: A1208, Overseas Decoration Building, #122 Zhenhua RD., Futian, Shenzhen, China





The Future of Analog IC Technology®

MP6902

Fast Turn-off Intelligent Controller

DESCRIPTION

The MP6902 is a Low-Drop Diode Emulator IC for Flyback converters which combined with an external switch replaces Schottky rectification diodes for high efficiency. The chip regulates the forward drop of an external switch to about 70mV and switches it off as soon as the voltage becomes negative. MP6902 has a light-load sleep mode that reduces the quiescent current to <300uA.

FEATURES

- Supports DCM and Quasi-Resonant Flyback Converters
- Works with 12V Standard and 5V Logic Level FETS
- Compatible with Energy Star, 1W Standby Requirements
- V_{DD} Range From 8V to 24V
- 70mV V_{DS} Regulation Function ⁽¹⁾
- Fast Turn-off Total Delay of 20ns
- Max 400kHz Switching Frequency
- Light Load Mode Function ⁽¹⁾ with <300µA Quiescent Current
- Supports High-side and Low-side Rectification
- Power Savings of Up to 1.5W in a Typical Notebook Adapter

APPLICATIONS

- Industrial Power Systems
- Distributed Power Systems
- Battery Powered Systems
- Flyback Converters

All MPS parts are lead-free and adhere to the RoHS directive. For MPS green status, please visit MPS website under Quality Assurance.

"MPS" and "The Future of Analog IC Technology" are Registered Trademarks of Monolithic Power Systems, Inc.

Notes:

- 1) Related issued patent: US Patent US8,067,973; US8,400,790. CN Patent ZL201010504140.4; ZL200910059751.X. Other patents pending.

TYPICAL APPLICATION

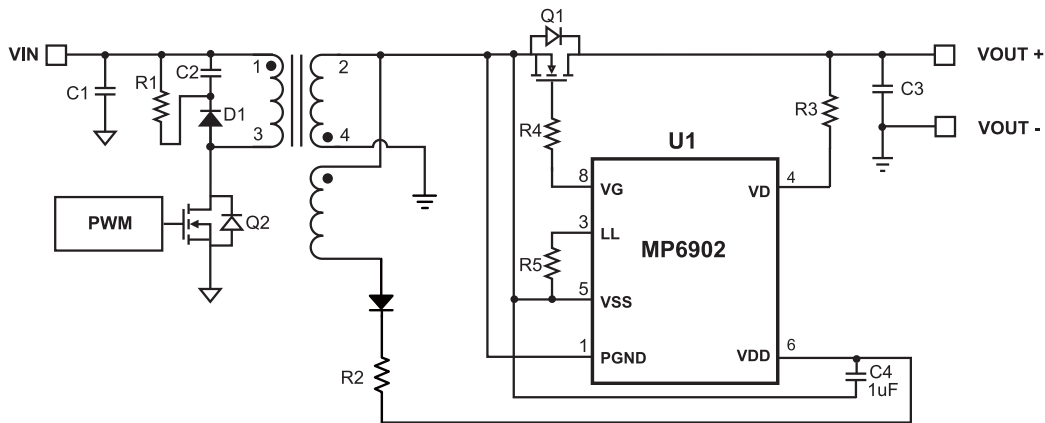

ORDERING INFORMATION

Part Number*	Package	Top Marking
MP6902DS	SOIC8	MP6902DS

* For Tape & Reel, add suffix -Z (e.g. MP6902DS-Z);
 For RoHS Compliant Packaging, add suffix -LF; (e.g. MP6902DS-LF-Z)

PACKAGE REFERENCE

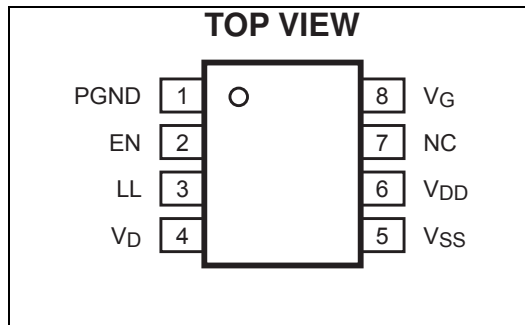

ABSOLUTE MAXIMUM RATINGS ⁽²⁾

V_{DD} to V_{SS}	-0.3V to +27V
PGND to V_{SS}	-0.3V to +0.3V
V_G to V_{SS}	-0.3V to V_{CC}
V_D to V_{SS}	-0.7V to +180V
LL, EN to V_{SS}	-0.3V to +6.5V
Maximum Operating Frequency	400 kHz
Continuous Power Dissipation ($T_A=+25^\circ\text{C}$) ⁽³⁾	1.4W
Junction Temperature	150°C
Lead Temperature (Solder)	260°C
Storage Temperature	-55°C to +150°C

Recommended Operation Conditions ⁽⁴⁾

V_{DD} to V_{SS}	8V to 24V
Operating Junction Temp. (T_J)	-40°C to +125°C

<i>Thermal Resistance</i> ⁽⁵⁾	θ_{JA}	θ_{JC}
SOIC8	90	45 ... °C/W

Notes:

- 2) Exceeding these ratings may damage the device.
- 3) The maximum allowable power dissipation is a function of the maximum junction temperature $T_J(\text{MAX})$, the junction-to-ambient thermal resistance θ_{JA} , and the ambient temperature T_A . The maximum allowable continuous power dissipation at any ambient temperature is calculated by $P_D(\text{MAX})=(T_J(\text{MAX})-T_A)/\theta_{JA}$. Exceeding the maximum allowable power dissipation will cause excessive die temperature, and the regulator will go into thermal shutdown. Internal thermal shutdown circuitry protects the device from permanent damage.
- 4) The device is not guaranteed to function outside of its operating conditions.
- 5) Measured on JESD51-7, 4-layer PCB.

ELECTRICAL CHARACTERISTICS

$V_{DD} = 12V$, $T_A = +25^{\circ}C$, unless otherwise noted.

Parameter	Symbol	Conditions	Min	Typ	Max	Units
V_{DD} Voltage Range			8		24	V
V_{DD} UVLO Rising			5.0	6.0	7.0	V
V_{DD} UVLO Hysteresis			0.8	1	1.2	V
Operating Current	I_{CC}	$C_{LOAD}=5nF$, $F_{SW}=100kHz$		8	10	mA
Quiescent Current	I_q	$V_{SS}-V_D=0.5V$		2	3	mA
Shutdown Current		$V_{DD}=4V$		210	255	μA
		$V_{DD}=20V$, $EN=0V$		375	440	
Light-load Mode Current				290	380	μA
Thermal Shutdown				150		$^{\circ}C$
Thermal Shutdown Hysteresis				30		$^{\circ}C$
Enable UVLO Rising			1.1	1.5	1.9	V
Enable UVLO Hysteresis				0.2	0.4	V
Internal Pull-up Current On EN Pin				10	15	μA
CONTROL CIRCUITRY SECTION						
$V_{SS}-V_D$ Forward Voltage	V_{fwd}		55	70	85	mV
Turn-on Delay	T_{Don}	$C_{LOAD} = 5nF$		150		ns
	T_{Don}	$C_{LOAD} = 10nF$		250		ns
Input Bias Current On V_D Pin		$V_D = 180V$			1	μA
Minimum On-time ⁽⁵⁾	T_{MIN}	$C_{LOAD} = 5nF$		1.6		μs
Light-load-enter Delay	$T_{LL-Delay}$	$R_{LL}=100k\Omega$		100		μs
Light-load-enter Pulse Width	T_{LL}	$R_{LL}=100k\Omega$	1.3	1.75	2.2	μs
Light-load-enter Pulse Width Hysteresis	T_{LL-H}	$R_{LL}=100k\Omega$		0.2		μs
Light-load Resistor Value	R_{LL}		30		300	k Ω
Light-load Mode Exit Pulse Width Threshold (V_{DS})	V_{LL-DS}		-400	-250	-150	mV
Light-load Mode Enter Pulse Width Threshold (V_{GS}) ⁽⁶⁾	V_{LL-GS}			1.0		V
GATE DRIVER SECTION						
V_G (Low)		$I_{LOAD}=1mA$		0.05	0.1	V
V_G (High)		$V_{DD} > 17V$	13	14	15	V
		$V_{DD} < 17V$	$V_{DD}-2.2$			
Turn-off Threshold ($V_{SS}-V_D$)				30		mV
Turn-off Propagation Delay		$V_D=V_{SS}$		15		ns
Turn-off Total Delay	T_{Doff}	$V_D = V_{SS}$, $C_{LOAD}=5nF$, $R_{GATE}=0\Omega$		35		ns
	T_{Doff}	$V_D = V_{SS}$, $C_{LOAD}=10nF$, $R_{GATE}=0\Omega$		45		ns
Pull Down Impedance				1	2	Ω
Pull Down Current ⁽⁶⁾		$3V < V_G < 10V$		2		A

Notes:

6) Guaranteed by Design and Characterization.

PIN FUNCTIONS

Pin #	Name	Description
1	PGND	Power Ground, return for driver switch
2	EN	Enable pin, active high
3	LL	Light load timing setting. Connect a resistor to set the light load timing.
4	VD	FET drain voltage sense
5	VSS	Ground, also used as reference for VD
6	VDD	Supply Voltage
7	NC	No connection
8	VG	Gate drive output

TYPICAL PERFORMANCE CHARACTERISTICS

$V_{DD} = 12V$, unless otherwise noted.

V_{FWD} vs. Temperature

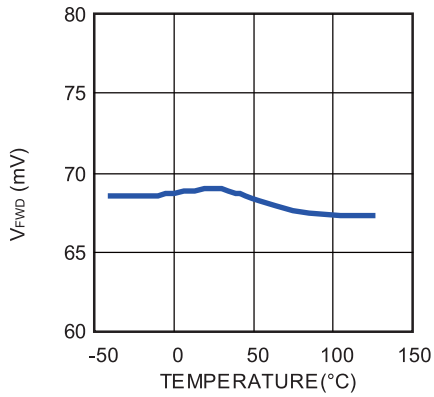

Turn off threshold vs. Temperature

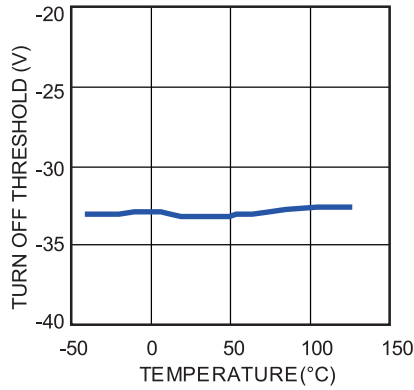

Quiescent Current vs. Temperature

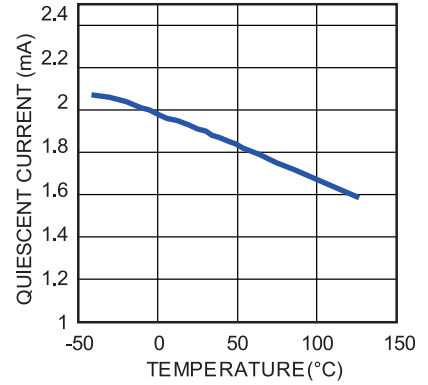

Shutdown Current vs. Temperature

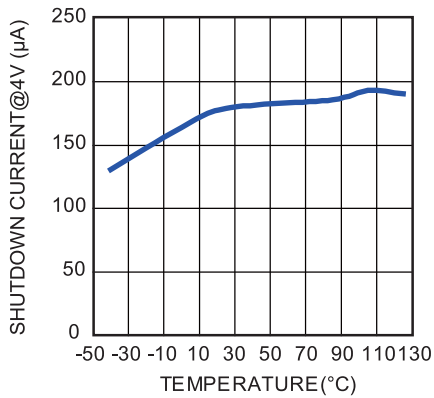

V_{DD} UVLO Rising vs. Temperature

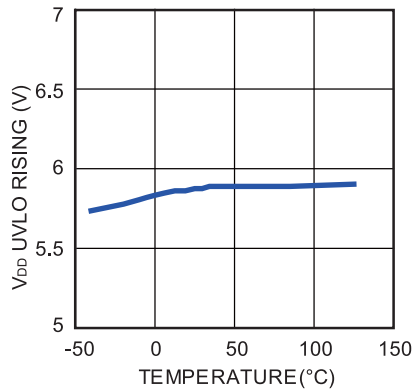

Operation in 90W Flyback Application

($V_{IN}=250Vac$, $I_{OUT}=1A$)

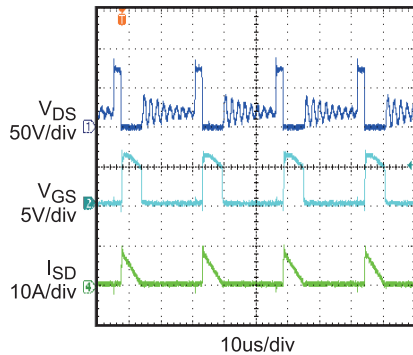

Operation in 90W Flyback Application

($V_{IN}=250Vac$, $I_{OUT}=4.7A$)

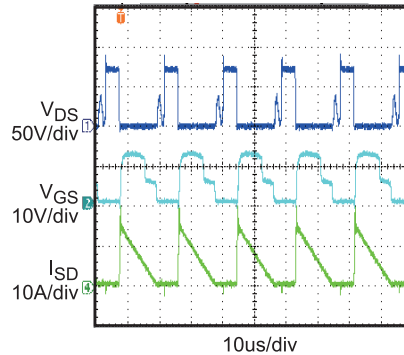

Notes:

7) See Figure 13 for the test circuit.

BLOCK DIAGRAM

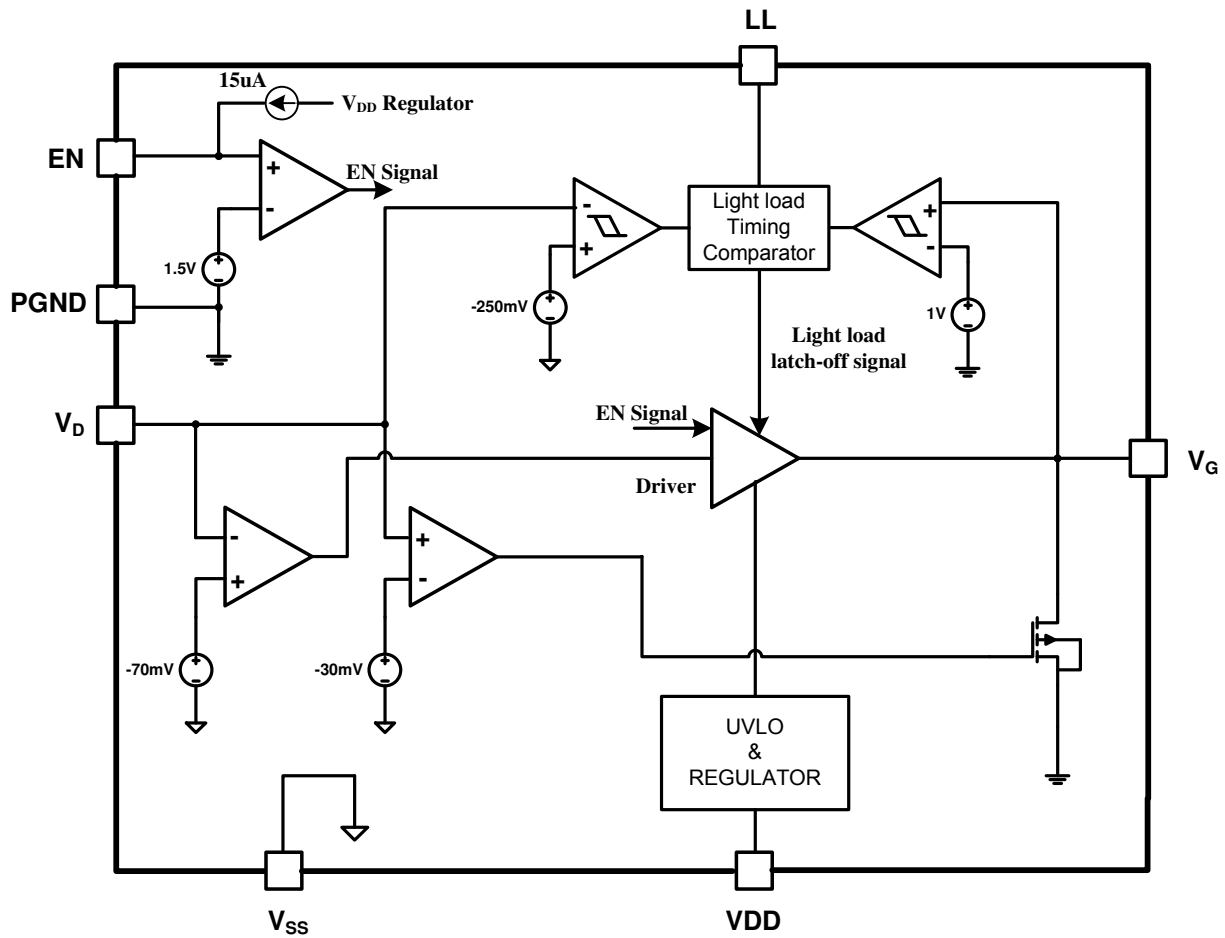

Figure 1—Function Block Diagram

OPERATION

The MP6902 supports operation in DCM and Quasi-Resonant Flyback converters. The control circuitry controls the gate in forward mode and will turn the gate off when the MOSFET current is fairly low.

Blanking

The control circuitry contains a blanking function. When it pulls the MOSFET on/off, it makes sure that the on/off state at least lasts for some time. The turn on blanking time is $\sim 1.6\mu\text{s}$, which determines the minimum on-time. During the turn on blanking period, the turn off threshold is not totally blanked, but changes the threshold voltage to $\sim +50\text{mV}$ (instead of -30mV). This assures that the part can always be turned off even during the turn on blanking period. (Albeit slower)

VD Clamp

Because V_D can go as high as 180V, a High-Voltage JFET is used at the input. To avoid excessive currents when V_g goes below -0.7V , a small resistor is recommended between V_D and the drain of the external MOSFET.

Under-Voltage Lockout (UVLO)

When the V_{DD} is below UVLO threshold, the part is in sleep mode and the V_g pin is pulled low by a $10\text{k}\Omega$ resistor.

Enable pin

If EN is pulled low, the part is in sleep mode.

Thermal shutdown

If the junction temperature of the chip exceeds 170°C , the V_g will be pulled low and the part stops switching. The part will return to normal function after the junction temperature has dropped to 120°C .

Thermal Design

If the dissipation of the chip is higher than 100mW due to switching frequencies above 100kHz .

Turn-on Phase

When the synchronous MOSFET is conducting, current will flow through its body diode which generates a negative V_{ds} across it. Because this

body diode voltage drop ($< -500\text{mV}$) is much smaller than the turn on threshold of the control circuitry (-70mV), which will then pull the gate driver voltage high to turn on the synchronous MOSFET after about 150ns turn on delay (Defined in Figure 2).

As soon as the turn on threshold (-70mV) is triggered, a blanking time (Minimum on-time: $\sim 1.6\mu\text{s}$) will be added during which the turn off threshold will be changed from -30mV to $+50\text{mV}$. This blanking time can help to avoid error trigger on turn on turn off threshold caused by the turn on ringing of the synchronous MOSFET.

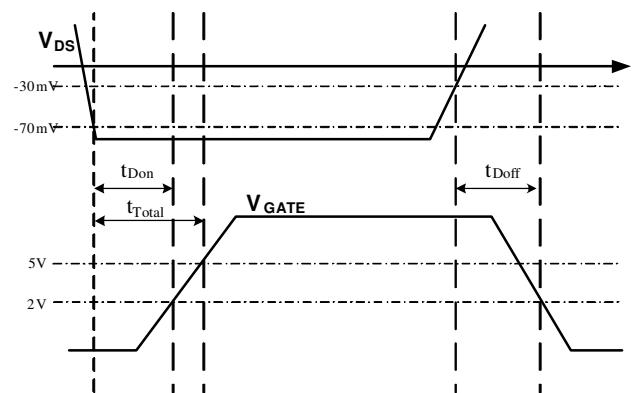

Figure 2—Turn on and Turn off delay

Conducting Phase

When the synchronous MOSFET is turned on, V_{ds} becomes to rise according to its on resistance, as soon as V_{ds} rises above the turn on threshold (-70mV), the control circuitry stops pulling up the gate driver which leads the gate voltage is pulled down by the internal pull-down resistance ($10\text{k}\Omega$) to larger the on resistance of synchronous MOSFET to ease the rise of V_{ds} . By doing that, V_{ds} is adjusted to be around -70mV even when the current through the MOS is fairly small, this function can make the driver voltage fairly low when the synchronous MOSFET is turned off to fast the turn off speed (this function is still active during turn on blanking time which means the gate driver could still be turned off even with very small duty of the synchronous MOSFET).

Turn-off Phase

When V_{ds} rises to trigger the turn off threshold (-30mV), the gate voltage is pulled to low after about 20ns turn off delay (defined in Figure 2) by the control circuitry. Similar with turn-on phase, a 200ns blanking time is added after the synchronous MOSFET is turned off to avoid error trigger.

Figure 3 shows synchronous rectification operation at heavy load condition. Due to the high current, the gate driver will be saturated at first, during which the gate driver voltage is kept at ~2V lower than V_{DD} (when $V_{DD} > 16V$, gate driver will be internal clamped at 14V). After V_{ds} goes to above -70mV, gate driver voltage decreases to adjust the V_{ds} to typical -70mV.

Figure 4 shows synchronous rectification operation at light load condition. Due to the low current, the gate driver voltage never saturates but begins to decrease as soon as the synchronous MOSFET is turned on and adjust the V_{ds} .

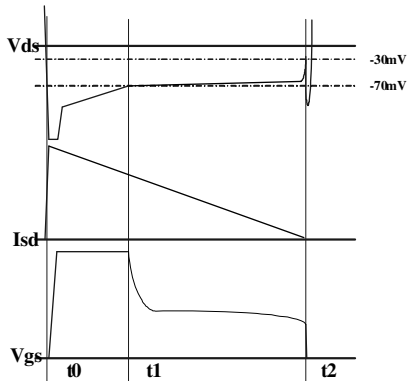

Figure 3—Synchronous Rectification Operation at heavy load

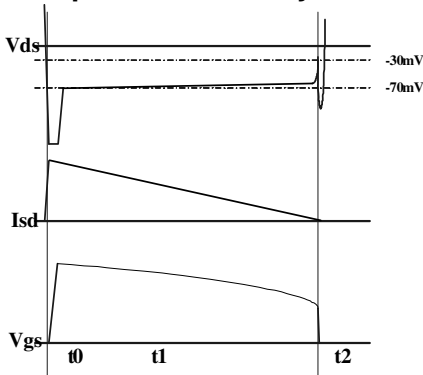

Figure 4—Synchronous Rectification Operation at light load

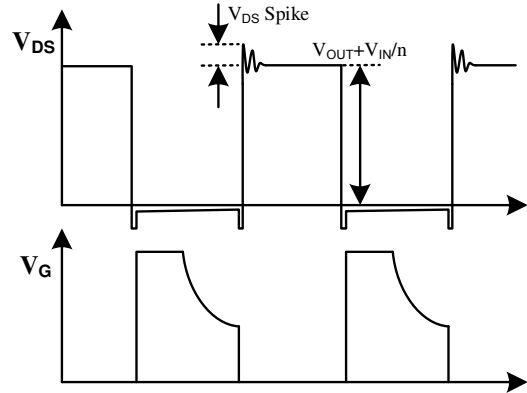

Figure 5—Drain-Source and Gate Driver voltage on SR MOFET

Figure 5 shows the whole synchronous rectification waveform on drain-source voltage V_{DS} and gate driver signal V_{GS} . For safe operation of the IC, it is required:

$$V_{OUT} + V_{IN} / n + V_{DS_Spike} < 180V * k$$

Where 180V is the maximum voltage rating on V_D pin of MP6902, V_{IN}/V_{OUT} is the input/output DC voltage, n is the turn ratio from primary to secondary of the power transformer, V_{DS_Spike} is the spike voltage on drain-source which is lead by leakage inductance, while k is the de-rating factor which is usually selected as 0.7~0.8.

Light-load Latch-off Function

The gate driver of MP6902 is latched to save the driver loss at light-load condition to improve efficiency. When the synchronous MOSFET's conducting period keeps lower than light load timing (T_{LL}) for longer than the light-load-enter delay ($T_{LL-Delay}$), MP6902 enters light-load mode and latches off the gate driver. Here the synchronous MOSFET's conducting period is from turn on of the gate driver to the moment when V_{GS} drops to below 1V (V_{LL_GS}). During light-load mode, MP6902 monitors the synchronous MOSFET's body diode conducting period by sensing the time duration of the V_{DS} below -250mV (V_{LL_DS}). If it is longer than $T_{LL} + T_{LL-H}$ (T_{LL-H} , light-load-enter pulse width hysteresis), the light-load mode is finished and gate driver of MP6902 is unlatched to restart the synchronous rectification.

For MP6902, the light load enter timing (T_{LL}) is programmable by connecting a resistor (R_{LL}) on LL pin, by monitoring the LL pin current (the LL pin voltage keeps at $\sim 2V$ internally), T_{LL} is set as following:

$$T_{LL} \approx R_{LL} (k\Omega) \cdot \frac{2.2\mu s}{100k\Omega}$$

SR MOSFET Selection and Driver Ability

The Power Mosfet selection proved to be a trade off between R_{on} and Q_g . In order to achieve high efficiency, the Mosfet with smaller R_{on} is always preferred, while the Q_g is usually larger with smaller R_{on} , which makes the turn-on/off speed lower and lead to larger power loss. For MP6902, because V_{ds} is regulated at $\sim 70mV$ during the driving period, the Mosfet with too small R_{on} is not recommend, because the gate driver may be pulled down to a fairly low level with too small R_{on} when the Mosfet current is still fairly high, which make the advantage of the low R_{on} inconspicuous.

Figure 6 shows the typical waveform of QR flyback. Assume 50% duty cycle and the output current is I_{OUT} .

To achieve fairly high usage of the Mosfet’s R_{on} , it is expected that the Mosfet be fully turned on at least 50% of the SR conduction period:

$$V_{ds} = -I_c \times R_{on} = -2 \cdot I_{OUT} \times R_{on} \leq -V_{fwd}$$

Where V_{ds} is Drain-Source voltage of the Mosfet and V_{fwd} is the forward voltage threshold of MP6902, which is $\sim 70mV$.

So the Mosfet’s R_{on} is recommended to be no lower than $\sim 35/I_{OUT}$ (m Ω). (For example, for 5A application, the R_{on} of the Mosfet is recommended to be no lower than 7m Ω)

Figure 7 shows the corresponding total delay during turn-on period (t_{Total} , see Figure 2) with driving different Q_g Mosfet by MP6902. From Figure 7, with driving a 120nC Q_g Mosfet, the driver ability of MP6902 is able to pull up the gate driver voltage of the Mosfet to $\sim 5V$ in 300ns as soon as the body diode of the Mosfet is conducting, which greatly save the turn-on power loss in the Mosfet’s body diode.

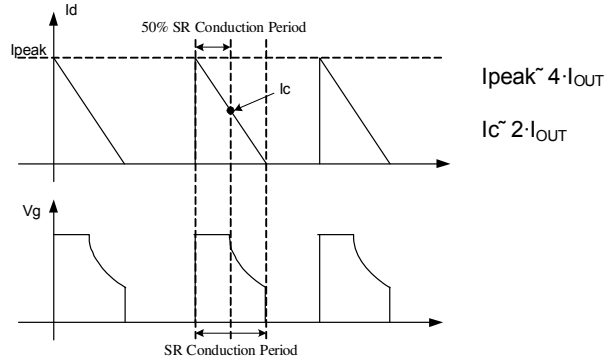

Figure 6—Synchronous Rectification typical waveforms in QR Flyback

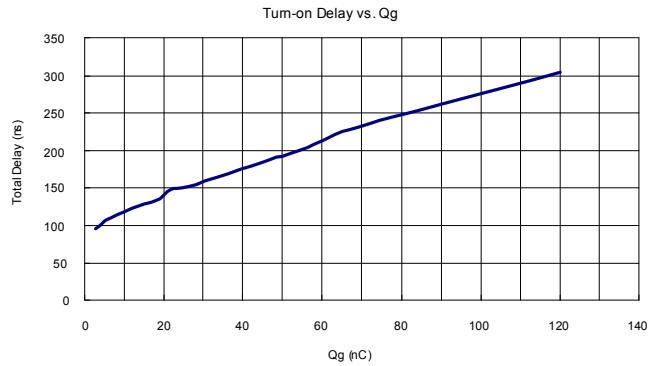

Figure 7—Total Turn-on Delay vs. Qg

Typical System Implementations

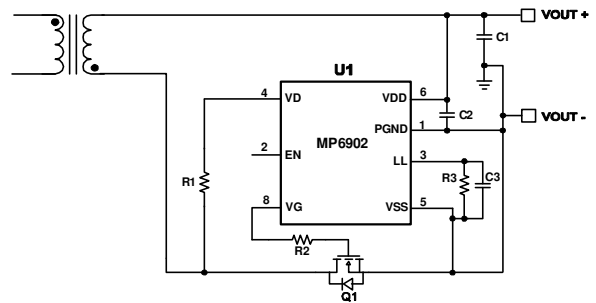

Figure 8— IC Supply derived directly from Output Voltage

Figure 8 shows the typical system implementation for the IC supply derived from output voltage, which is available in low-side rectification and the output voltage is recommended to be in the V_{DD} range of MP6902 (from 8V to 24V).

If output voltage is out of the V_{DD} range of MP6902 or high-side rectification is used, it is recommended to use an auxiliary winding from the power transformer for the IC supply, which is shown in Figure 9 and Figure.10.

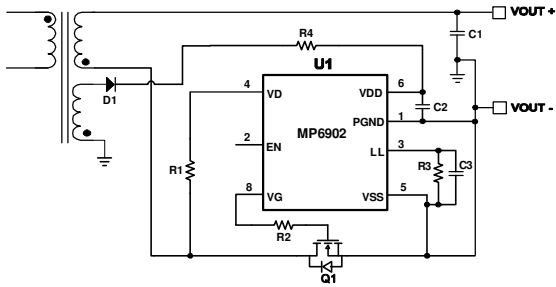

Figure 9— IC Supply derived from Auxiliary Winding in Low-Side Rectification

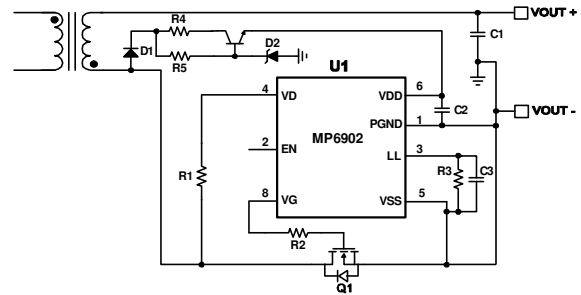

Figure 11— IC Supply derived from Secondary Winding through External LDO in Low-Side Rectification

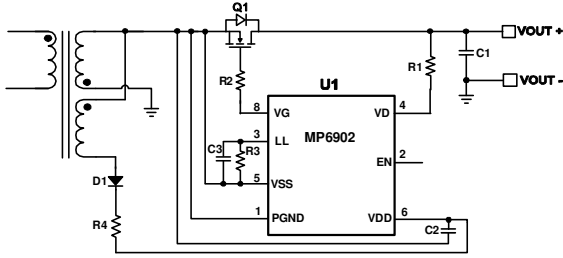

Figure 10— IC Supply derived from Auxiliary Winding in High-Side Rectification

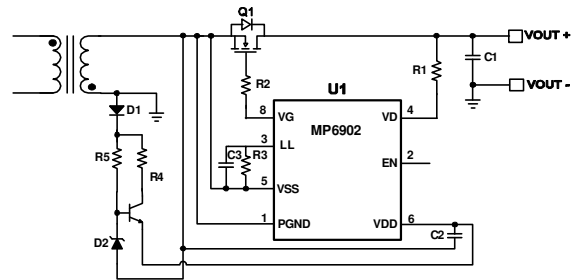
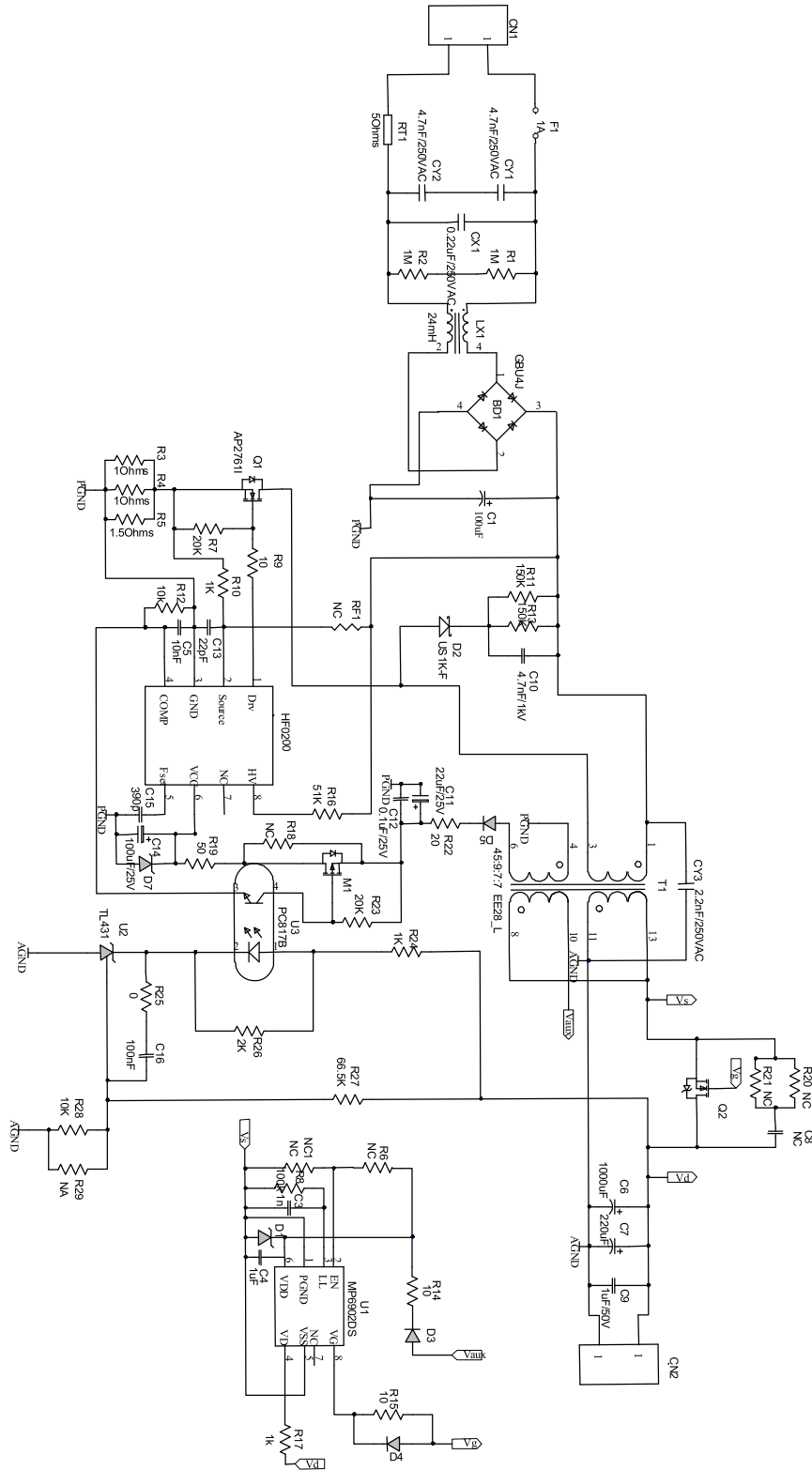
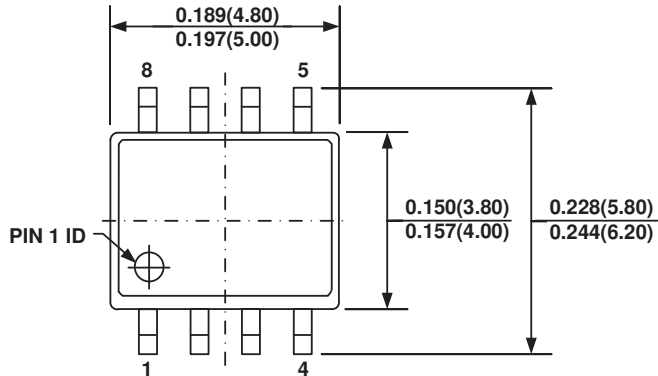
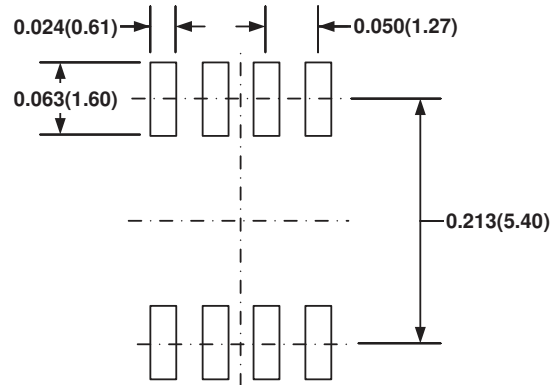
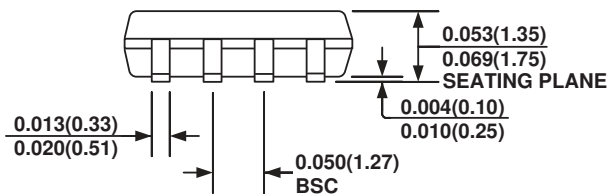
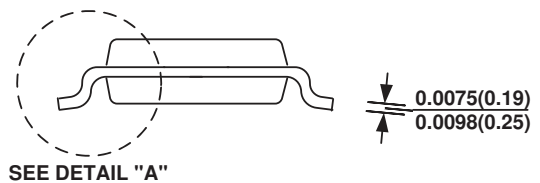
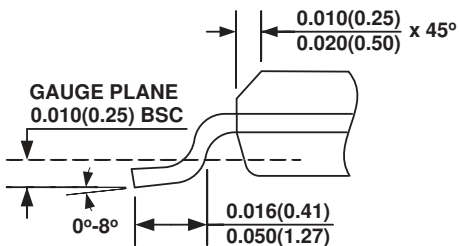

Figure 12— IC Supply derived from Secondary Winding through External LDO in High-Side Rectification

There is another non-auxiliary winding solution for the IC supply, which uses an external LDO circuit from the secondary transformer winding. See Figure.11 and Figure.12, compared with using auxiliary winding for IC supply, this solution has a bit higher power loss which is dissipate on the LDO circuit especially when the secondary winding voltage is high.

TYPICAL APPLICATION CIRCUIT

Figure 13—MP6902 for Secondary Synchronous Controller in 90W Flyback Application

PACKAGE INFORMATION
SOIC8

TOP VIEW

RECOMMENDED LAND PATTERN

FRONT VIEW

SIDE VIEW

DETAIL "A"
NOTE:

- 1) CONTROL DIMENSION IS IN INCHES. DIMENSION IN BRACKET IS IN MILLIMETERS.
- 2) PACKAGE LENGTH DOES NOT INCLUDE MOLD FLASH, PROTRUSIONS OR GATE BURRS.
- 3) PACKAGE WIDTH DOES NOT INCLUDE INTERLEAD FLASH OR PROTRUSIONS.
- 4) LEAD COPLANARITY (BOTTOM OF LEADS AFTER FORMING) SHALL BE 0.004" INCHES MAX.
- 5) DRAWING CONFORMS TO JEDEC MS-012, VARIATION AA.
- 6) DRAWING IS NOT TO SCALE.

NOTICE: The information in this document is subject to change without notice. Users should warrant and guarantee that third party Intellectual Property rights are not infringed upon when integrating MPS products into any application. MPS will not assume any legal responsibility for any said applications.