



Chipsmall Limited consists of a professional team with an average of over 10 year of expertise in the distribution of electronic components. Based in Hongkong, we have already established firm and mutual-benefit business relationships with customers from,Europe,America and south Asia,supplying obsolete and hard-to-find components to meet their specific needs.

With the principle of “Quality Parts,Customers Priority,Honest Operation,and Considerate Service”,our business mainly focus on the distribution of electronic components. Line cards we deal with include Microchip,ALPS,ROHM,Xilinx,Pulse,ON,Everlight and Freescale. Main products comprise IC,Modules,Potentiometer,IC Socket,Relay,Connector.Our parts cover such applications as commercial,industrial, and automotives areas.

We are looking forward to setting up business relationship with you and hope to provide you with the best service and solution. Let us make a better world for our industry!



Contact us

Tel: +86-755-8981 8866 Fax: +86-755-8427 6832

Email & Skype: info@chipsmall.com Web: www.chipsmall.com

Address: A1208, Overseas Decoration Building, #122 Zhenhua RD., Futian, Shenzhen, China



DESCRIPTION

The MP7748S is a Class D Audio Amplifier for driving stereo speakers in single-ended configuration or a mono speaker in bridge-tied-load configuration. It is fully integrated audio amplifier which dramatically reduces solution size by integrating the following:

- 200m Ω power MOSFETs
- Startup / Shutdown pop elimination
- Short circuit protection circuits

The MP7748S is capable of delivering 30W per channel into 4 Ω speaker in single-ended output structure, or delivering 60W into 8 Ω speaker in bridge-tied-load output structure. MPS Class D Audio Amplifiers exhibit the high fidelity of a Class A/B amplifier at high efficiencies. The circuit is based on the MPS' proprietary variable frequency topology that delivers excellent linearity, fast response time and operates on a single power supply.

MP7748S features programmable VDD shutdown voltage for each channel by controlling the UVP node voltage. The default VDD shutdown (rising threshold) voltage is 8.4V if the UVP pin is NC.

The MP7748S is available in TSSOP28-Exposed Package.

FEATURES

- 9.5V to 36V Operation from a Single Supply
- ± 5.5 A Peak Current Output
- Output Power at 30V and 10%THD:
 - Stereo Single Ended: 2 x 30W into 4 Ω Load,
 - Bridge Tied Load: 60W into 8 Ω Load
- THD+N = 0.02% at 1W, 8 Ω
- > 90% Efficiency at 10%THD
- Low Noise (160 μ V with SE configuration, 145 μ V with BTL configuration)
- Switching Frequency Up to 1MHz
- Integrated Startup and Shutdown Pop Elimination Circuit
- Programmable UVP
- Thermal and Short Circuit Protection
- Integrated Power FETs
- Available in TSSOP28-Exposed Package

APPLICATIONS

- Portable Docking Stations
- Surround Sound DVD Systems
- Televisions
- Flat Panel Monitors
- Multimedia Computers
- Home Stereo Systems

All MPS parts are lead-free and adhere to the RoHS directive. For MPS green status, please visit MPS website under Products, Quality Assurance page. "MPS" and "The Future of Analog IC Technology" are registered trademarks of Monolithic Power Systems, Inc.

TYPICAL APPLICATION

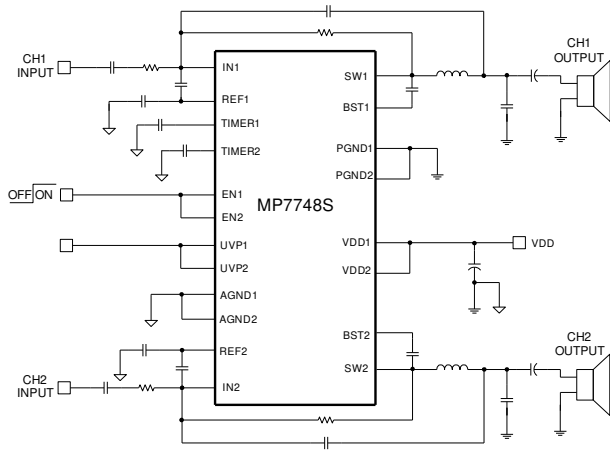

Stereo SE Application Circuit

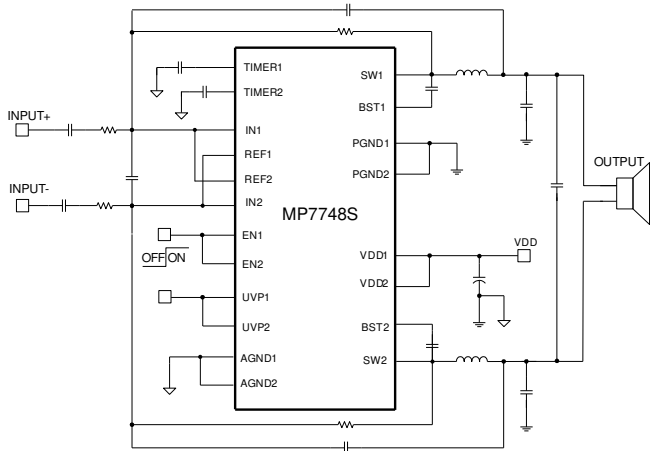
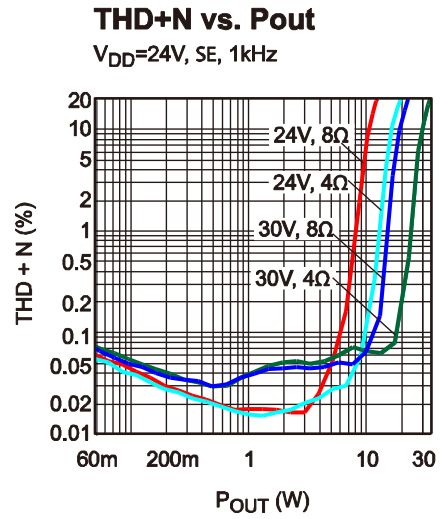

Mono BTL Application Circuit

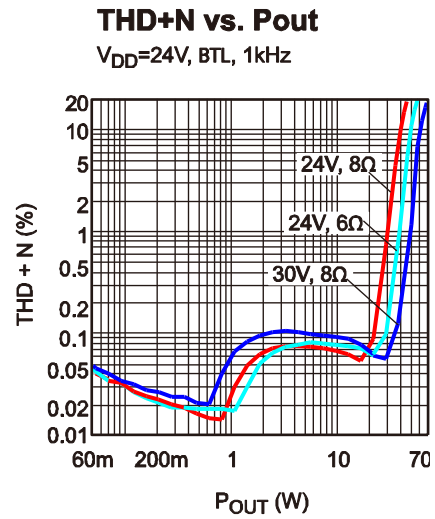

ORDERING INFORMATION

Part Number*	Package	Top Marking
MP7748SGF	TSSOP28-EP	MP7748S

* For Tape & Reel, add suffix -Z (e.g. MP7748SGF-Z).

PACKAGE REFERENCE

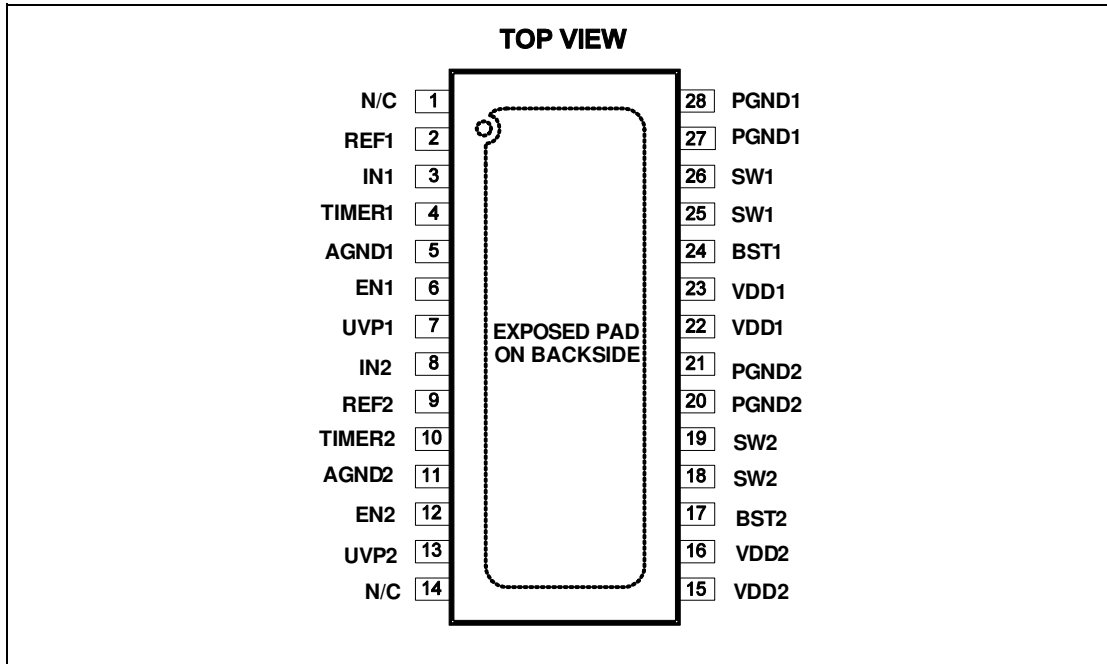

ABSOLUTE MAXIMUM RATINGS ⁽¹⁾

Supply Voltage V_{DD}	40V
BS Voltage.....	$V_{SW} - 0.3V$ to $V_{SW} + 6.5V$
V_{UVP} , V_{TIMER} , V_{EN}	-0.3V to +6V
V_{SW}	-0.3V to $V_{DD} + 1V$
V_{REF} , V_{IN}	-0.3V to +34V
AGND to PGND.....	-0.3V to +0.3V
Continuous Power Dissipation ($T_A = +25^\circ C$) ⁽²⁾	3.9W
Junction Temperature.....	150°C
Lead Temperature.....	260°C
Storage Temperature.....	-65°C to +150°C

Recommended Operating Conditions ⁽³⁾

Supply Voltage V_{DD}	9.5V to 36V
Operating Junct. Temp (T_J).....	-40°C to +125°C

Thermal Resistance ⁽⁴⁾	θ_{JA}	θ_{JC}
TSSOP28-EP.....	32.....	6..... °C/W

Notes:

- Exceeding these ratings may damage the device.
- The maximum allowable power dissipation is a function of the maximum junction temperature T_J (MAX), the junction-to-ambient thermal resistance θ_{JA} , and the ambient temperature T_A . The maximum allowable continuous power dissipation at any ambient temperature is calculated by P_D (MAX) = $(T_J$ (MAX) - T_A) / θ_{JA} . Exceeding the maximum allowable power dissipation will cause excessive die temperature, and the regulator will go into thermal shutdown. Internal thermal shutdown circuitry protects the device from permanent damage.
- The device is not guaranteed to function outside of its operating conditions.
- Measured on JESD51-7, 4-layer PCB.

ELECTRICAL CHARACTERISTICS (5, 6)

$V_{DD} = 24V$, $V_{EN} = 5V$, $T_A = +25^{\circ}C$, unless otherwise noted.

Parameters	Symbol	Condition	Min	Typ	Max	Units
Standby Current		$V_{EN} = 0V, NIN=PIN=Float$		100	130	μA
Quiescent Current	I_Q	SW=Low		3.1	3.5	mA
SW On Resistance		Sourcing and Sinking		0.2		Ω
Short Circuit Current		Sourcing and Sinking	4.5	5.5	6.5	A
EN Enable Threshold Voltage		V_{EN} Rising		1.4	2.0	V
		V_{EN} Falling	0.4	1.0		V
EN Enable Input Current		$V_{EN} = 5V$		5		μA
External Undervoltage Detection	V_{UVP}		2	2.2	2.4	V
External Undervoltage Detection Hysteresis Voltage	V_{Hys}			0.3		V
Thermal Shutdown Trip Point		T_J Rising		150		$^{\circ}C$
Thermal Shutdown Hysteresis				30		$^{\circ}C$

Note:

- 5) The device is not guaranteed to function outside its operating rating.
- 6) Electrical Characteristics are for the IC only with no external components except bypass capacitors.

OPERATING SPECIFICATIONS ⁽⁷⁾

Circuit of figure 5, single-ended output configuration, $V_{DD} = 30V$, $Gain=8.25V/V$, $V_{EN} = 5V$, $T_A = +25^{\circ}C$, unless otherwise noted.

Parameters	Symbol	Condition	Min	Typ	Max	Units	
Standby Current		$V_{EN} = 0V$		100		μA	
Quiescent Current		Switching, no load		22		mA	
Power Output		$f = 1kHz$, THD+N = 10%, 4 Ω Load		30		W	
		$f = 1kHz$, THD+N = 10%, 8 Ω Load		17		W	
THD+ Noise		$P_{OUT} = 1W$, $f = 1kHz$, 4 Ω Load		0.04		%	
		$P_{OUT} = 1W$, $f = 1kHz$, 8 Ω Load		0.02		%	
Efficiency		$f = 1kHz$, $P_{OUT} = 30W$, 4 Ω Load		90		%	
		$f = 1kHz$, $P_{OUT} = 17W$, 8 Ω Load		94		%	
Maximum Power Bandwidth				20		kHz	
Dynamic Range				96		dB	
Noise Floor		A-Weighted		160		μV	
Power Supply Rejection		$V_{CC}=24V$, Gain=8.25V/V, $V_{RIPPLE}=200mV_{PP}$ $C_R=100\mu F$	$f = 1kHz$		-59		dB
			$f = 217Hz$		-59		dB

Circuit of figure 6, bridge-tied-load output configuration, $V_{DD} = 30V$, $Gain=15V/V$, $V_{EN} = 5V$, $T_A = +25^{\circ}C$, unless otherwise noted.

Parameters	Symbol	Condition	Min	Typ	Max	Units	
Standby Current		$V_{EN} = 0V$		100		μA	
Quiescent Current		Switching, no load		26		mA	
Power Output		$f = 1kHz$, THD+N = 10%, 8 Ω Load		60		W	
THD+ Noise		$P_{OUT} = 1W$, $f = 1kHz$, 8 Ω Load		0.02		%	
Efficiency		$f = 1kHz$, $P_{OUT} = 60W$, 8 Ω Load		94		%	
Maximum Power Bandwidth				20		kHz	
Dynamic Range				103		dB	
Noise Floor		A-Weighted		145		μV	
Power Supply Rejection		$V_{CC}=24V$, Gain=15V/V, $V_{RIPPLE}=200mV_{PP}$	$f = 1kHz$		-60		dB
			$f = 217Hz$		-60		dB

Note:

7) Operating Specifications are for the IC in Typical Application circuit.

PIN FUNCTIONS

Pin #	Name	Description
1, 14	N/C	Not connected internally
2	REF1	Internal analog reference (VDD/2) for Amplifier 1. For SE configuration, connect a bypass capacitor from REF1 to AGND (10 μ F).
3	IN1	Inverting input for amplifier 1.
4	TIMER1	Internal timer input for Amplifier 1. Connect a capacitor from TIMER1 to AGND (2.2 μ F) to set the internal timer for startup pop elimination.
5	AGND1	Analog ground for Amplifier 1. Connect AGND1 to AGND2. Connect PGND to AGND at a single point.
6	EN1	Enable input for Amplifier 1. Drive EN1 high to turn on the Amplifier 1, low to turn it off.
7	UVP1	Under-voltage protection reference input for Amplifier 1. Connect UVP1 to UVP2.
8	IN2	Inverting input for amplifier 2.
9	REF2	Internal analog reference (VDD/2) for Amplifier 2. For SE configuration, connect a bypass capacitor from REF2 to AGND (10 μ F).
10	TIMER2	Internal timer input for Amplifier 2. Connect a capacitor from TIMER2 to AGND (2.2 μ F) to set the internal timer for startup pop elimination.
11	AGND2	Analog ground for Amplifier 2. Connect AGND2 to AGND1. Connect PGND to AGND at a single point.
12	EN2	Enable input for Amplifier 2. Drive EN2 high to turn on the Amplifier 2, low to turn it off.
13	UVP2	Under-voltage protection reference input for Amplifier 2. Connect UVP2 to UVP1.
15, 16	VDD2	Power supply input for Amplifier 2. Bypass VDD2 to PGND2 with a 1 μ F X7R capacitor (in addition to the main bulk capacitor), placed close to the VDD2 and PGND2 pins.
17	BST2	High-side MOSFET bootstrap input for Amplifier 2. A capacitor from BST2 to SW2 supplies the gate drive current to the internal high-side MOSFET.
18, 19	SW2	Switched power output for Amplifier 2.
20, 21	PGND2	Power ground for Amplifier 2. Connect PGND2 to PGND1. Connect PGND to AGND at a single point.
22, 23	VDD1	Power supply input for Amplifier 1. Bypass VDD1 to PGND1 with a 1 μ F X7R capacitor (in addition to the main bulk capacitor), placed close to the VDD1 and PGND1 pins.
24	BST1	High-side MOSFET bootstrap input for Amplifier 1. A capacitor from BST1 to SW1 supplies the gate drive current to the internal high-side MOSFET.
25, 26	SW1	Switched power output for Amplifier 1.
27, 28	PGND1	Power ground for Amplifier 1. Connect PGND1 to PGND2. Connect PGND to AGND at a single point.
	Exposed Pad	Connect exposed pad to GND plane for proper thermal performance.

TYPICAL PERFORMANCE CURVES

Circuit of Figure 5, single-ended output configuration, $V_{DD}=24V$, $V_{EN}=5V$, $A_V=8.2V/V$, $T_A = +25^\circ C$, unless otherwise noted.

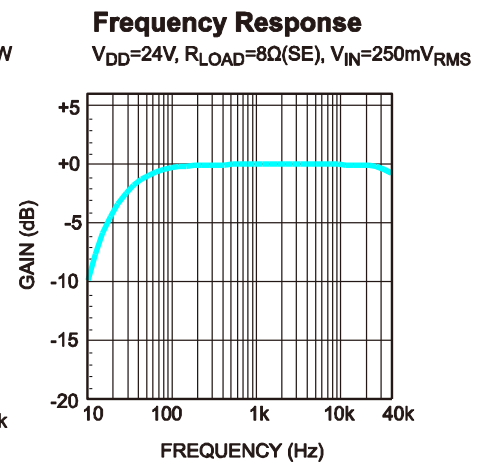
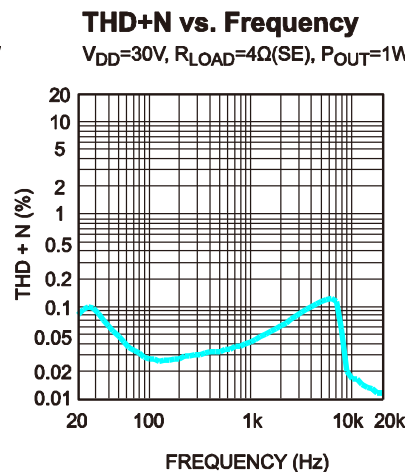
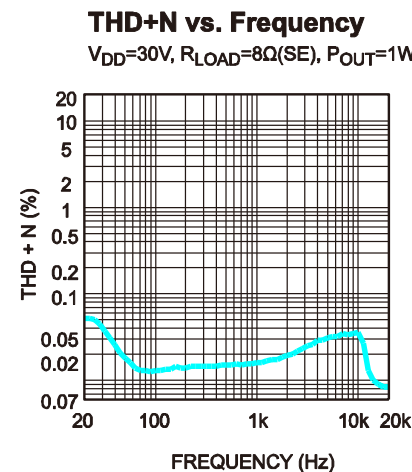
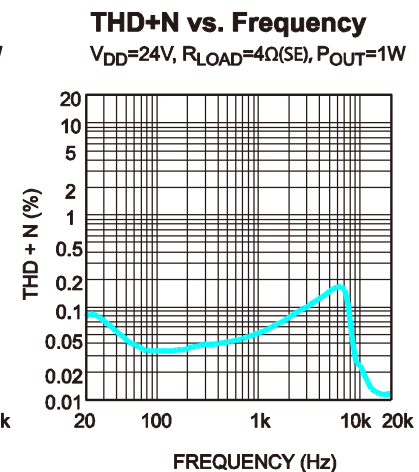
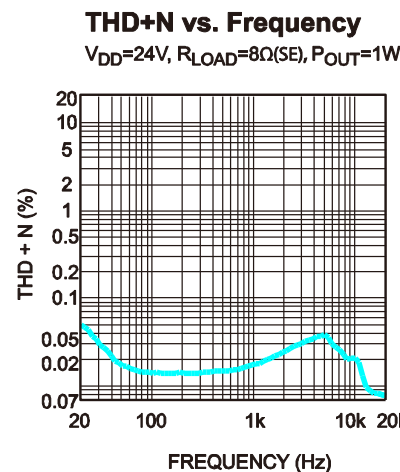
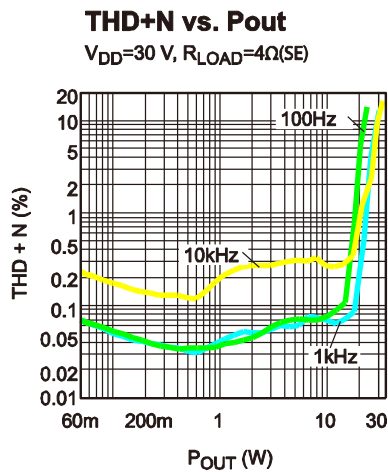
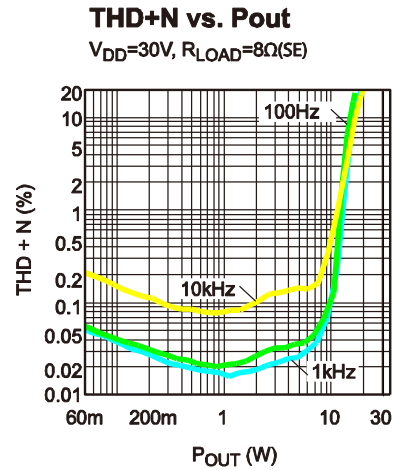
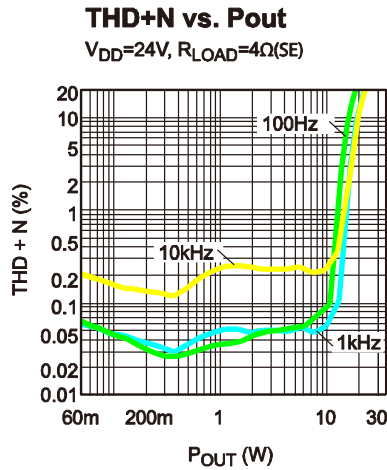
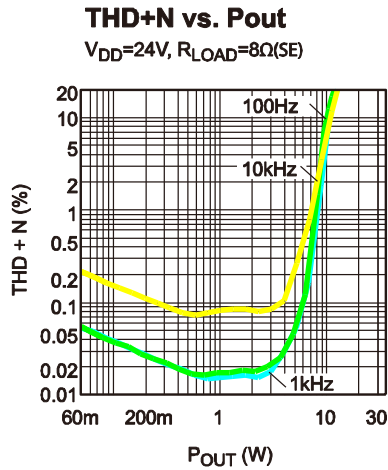

TYPICAL PERFORMANCE CURVES (continued)

Circuit of Figure 5, single-ended output configuration, $V_{DD}=24V$, $V_{EN}=5V$, $A_V=8.2V/V$, $T_A = +25^\circ C$, unless otherwise noted.

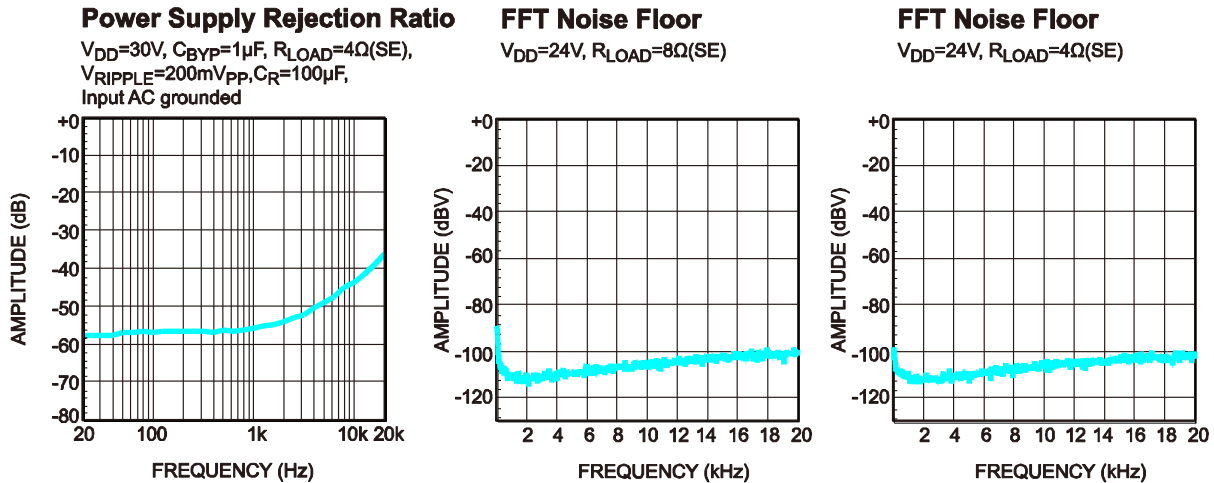
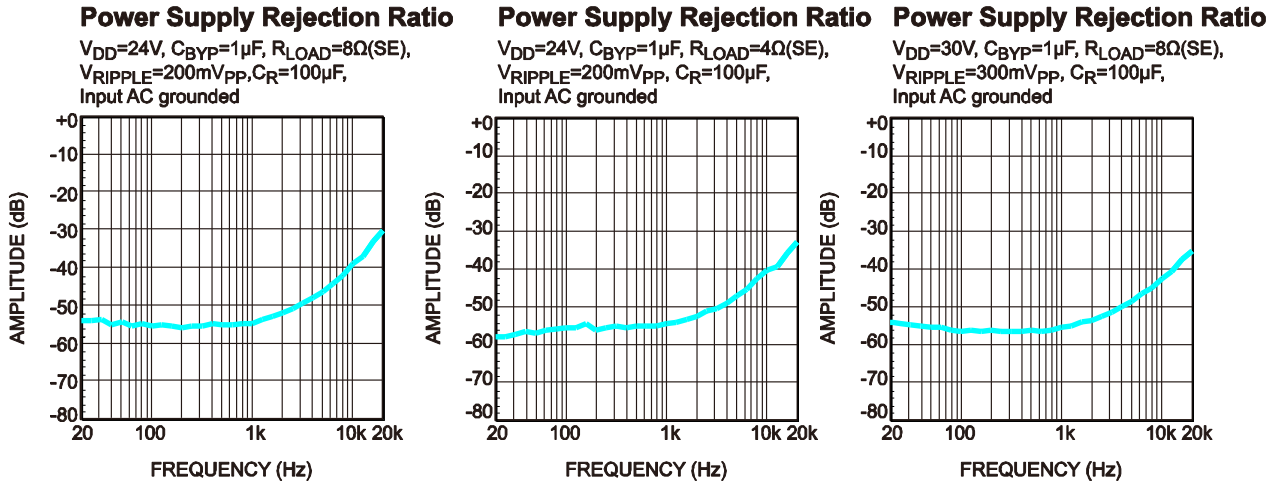
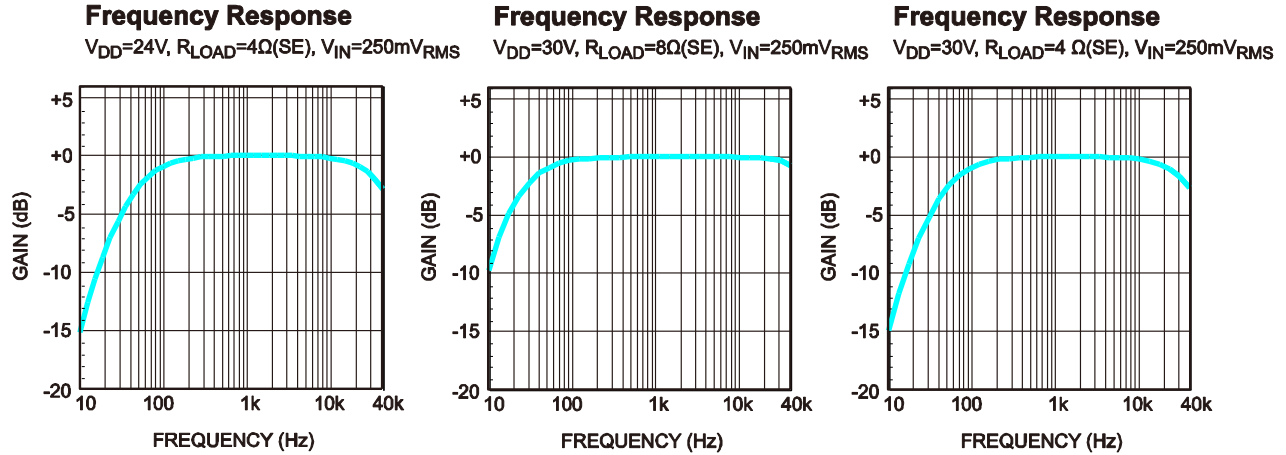

TYPICAL PERFORMANCE CURVES (continued)

Circuit of Figure 5, single-ended output configuration, $V_{DD}=24V$, $V_{EN}=5V$, $A_V=8.2V/V$, $T_A = +25^\circ C$, unless otherwise noted.

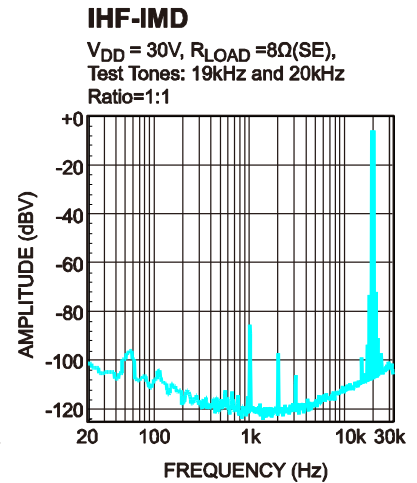
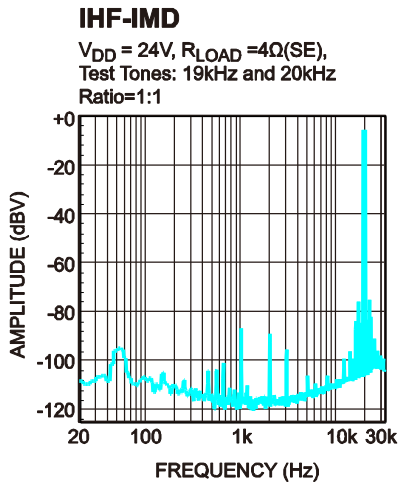
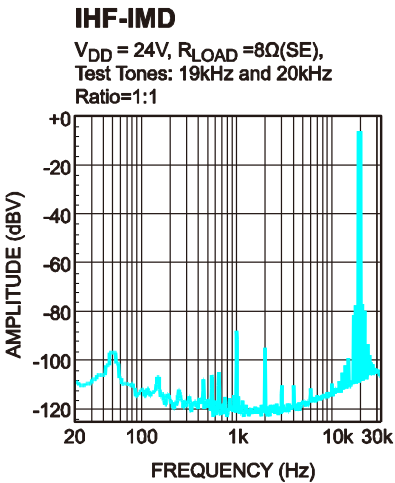
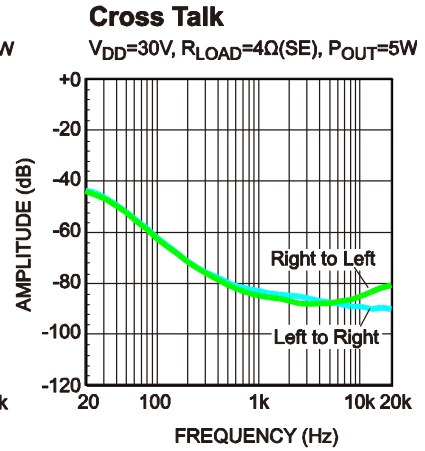
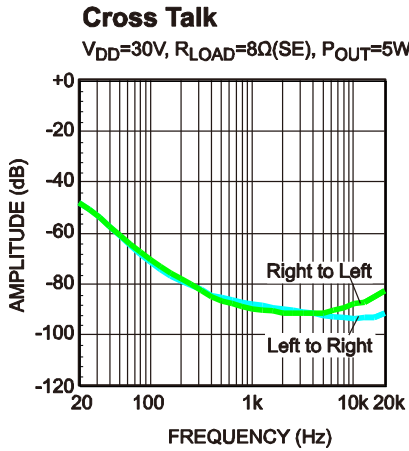
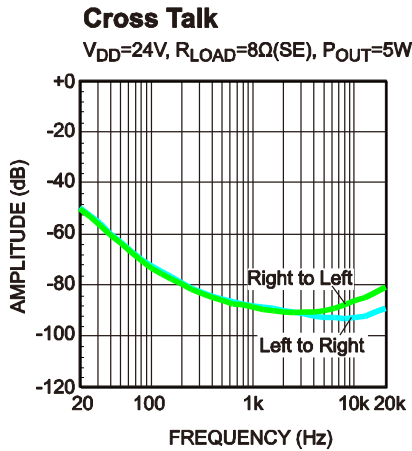
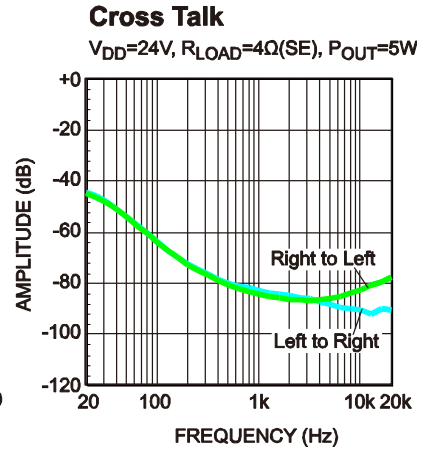
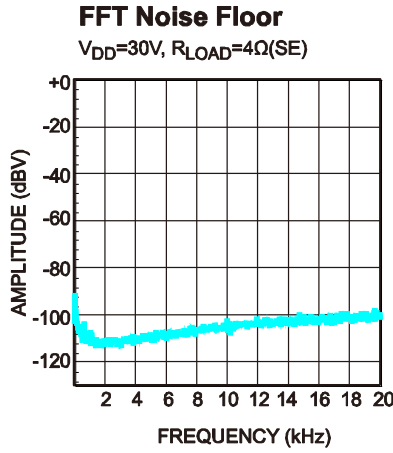
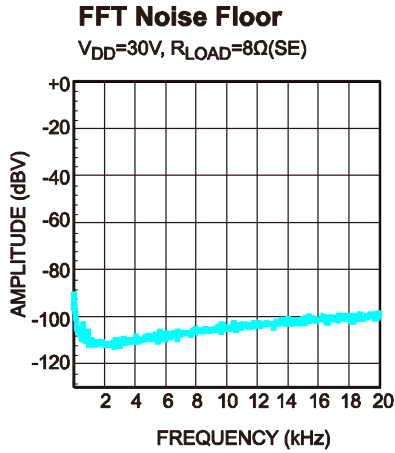

TYPICAL PERFORMANCE CURVES *(continued)*

Circuit of Figure 5, single-ended output configuration, $V_{DD}=24V$, $V_{EN}=5V$, $A_V=8.2V/V$, $T_A = +25^\circ C$, unless otherwise noted.

IHF-IMD

$V_{DD} = 30V$, $R_{LOAD} = 4\Omega$ (SE),
Test Tones: 19kHz and 20kHz
Ratio=1:1

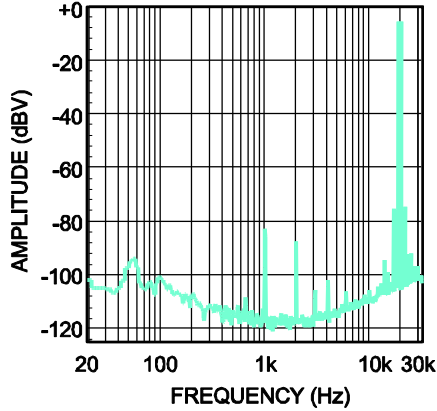

Efficiency vs. P_{OUT}

Input Signal Frequency=1kHz

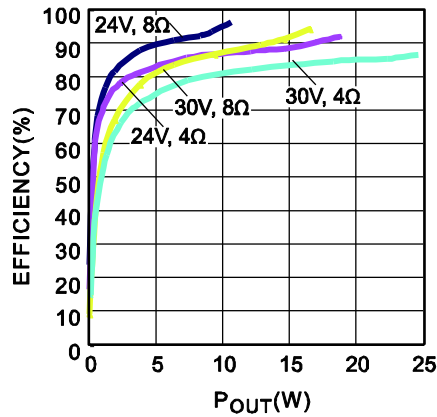

P_{OUT} vs. V_{DD}

Input Signal Frequency =1kHz
the same P_{OUT} for both channels

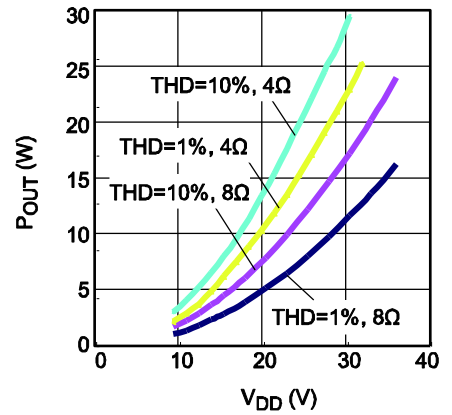

TYPICAL PERFORMANCE CURVES (continued)

Circuit of Figure 6, BTL output configuration, $V_{DD}=24V$, $V_{EN}=5V$, $A_V=15V/V$, $T_A = +25^\circ C$, unless otherwise noted.

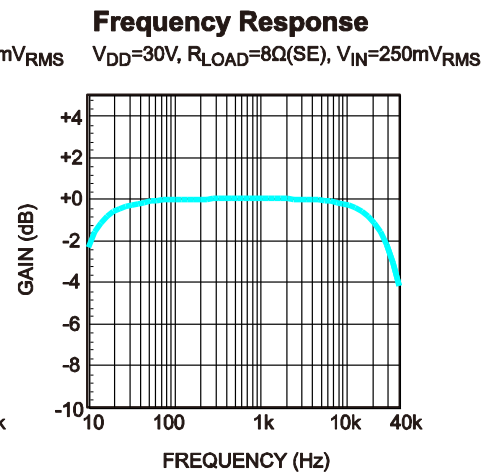
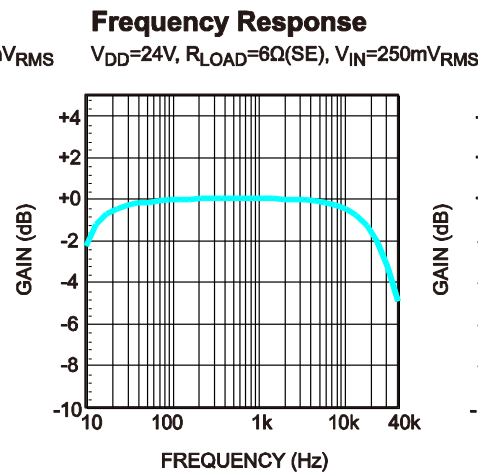
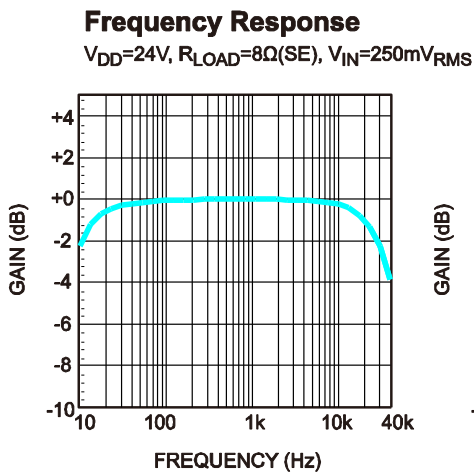
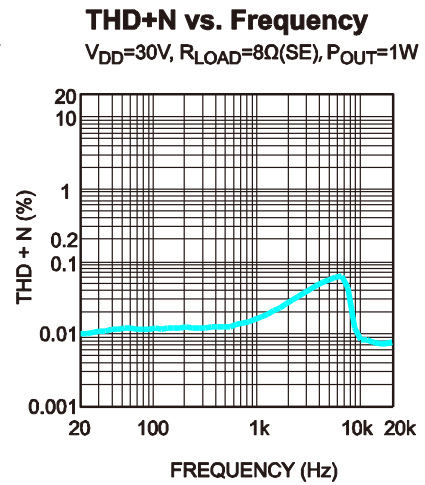
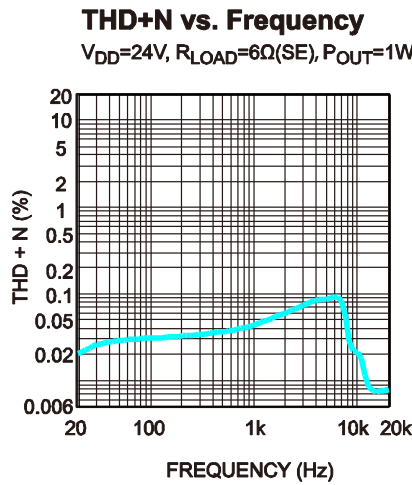
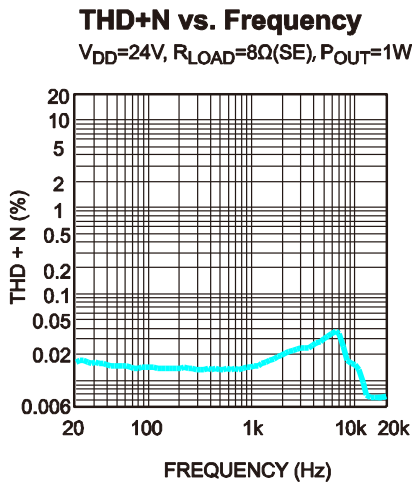
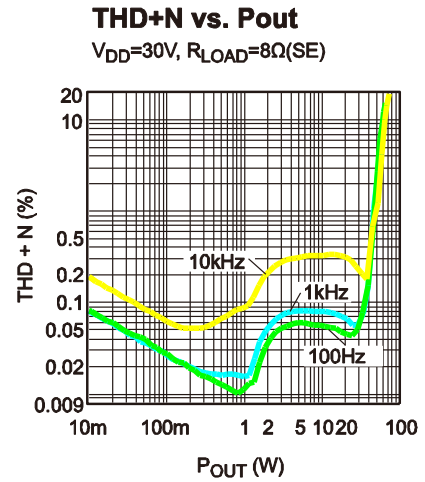
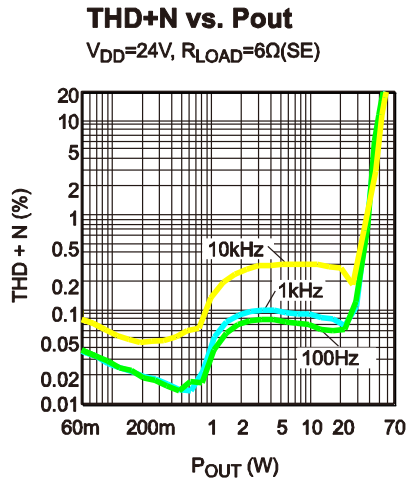
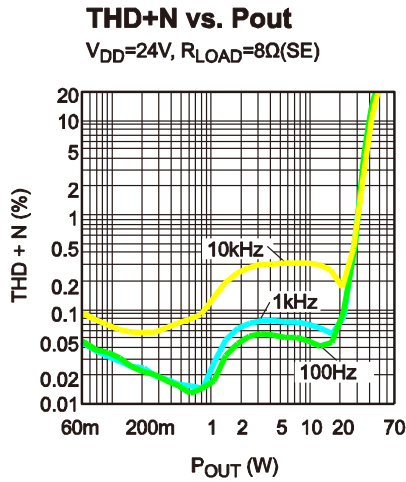

TYPICAL PERFORMANCE CURVES (continued)

Circuit of Figure 6, BTL output configuration, $V_{DD}=24V$, $V_{EN}=5V$, $A_V=15V/V$, $T_A = +25^\circ C$, unless otherwise noted.

Power Supply Rejection Ratio

$V_{DD}=24V$, $C_{BYP}=1\mu F$, $R_{LOAD}=8\Omega(SE)$,
 $V_{RIPPLE}=200mV_{PP}$, Input AC grounded

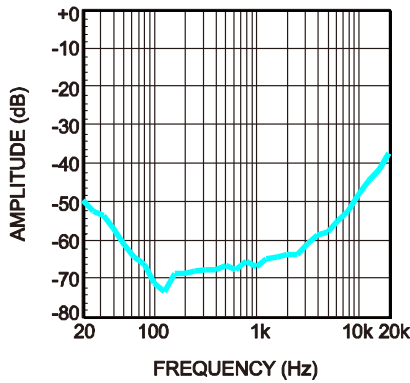

Power Supply Rejection Ratio

$V_{DD}=24V$, $C_{BYP}=1\mu F$, $R_{LOAD}=6\Omega(SE)$,
 $V_{RIPPLE}=200mV_{PP}$, Input AC grounded

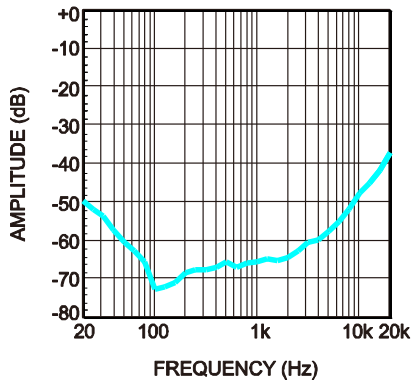

Power Supply Rejection Ratio

$V_{DD}=24V$, $C_{BYP}=1\mu F$, $R_{LOAD}=8\Omega(SE)$,
 $V_{RIPPLE}=200mV_{PP}$, Input AC grounded

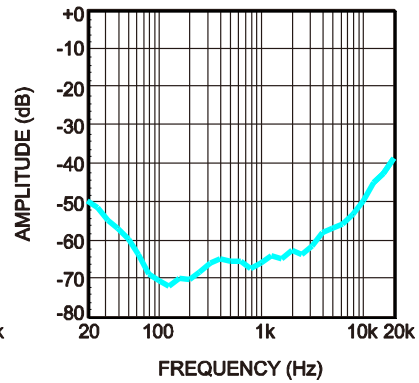

FFT Noise Floor

$V_{DD}=24V$, $R_{LOAD}=8\Omega(SE)$

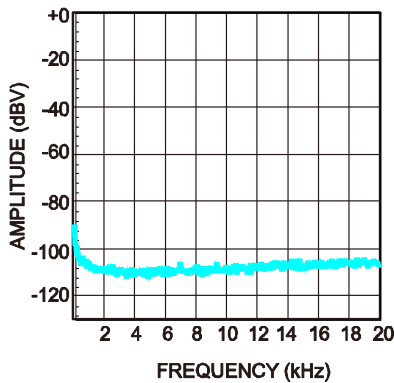

FFT Noise Floor

$V_{DD}=24V$, $R_{LOAD}=6\Omega(SE)$

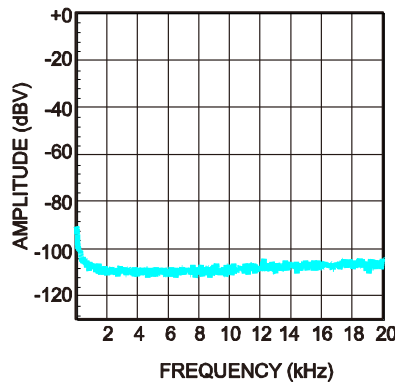

FFT Noise Floor

$V_{DD}=30V$, $R_{LOAD}=8\Omega(SE)$

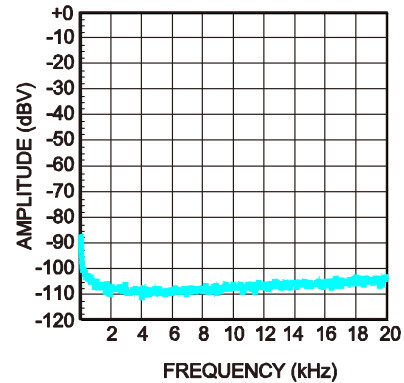

IHF-IMD

$V_{DD} = 24V$, $R_{LOAD} = 8\Omega(SE)$,
Test Tones: 19kHz and 20kHz
Ratio=1:1

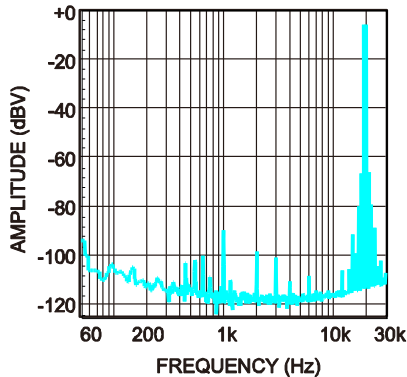

IHF-IMD

$V_{DD} = 24V$, $R_{LOAD} = 6\Omega(SE)$,
Test Tones: 19kHz and 20kHz
Ratio=1:1

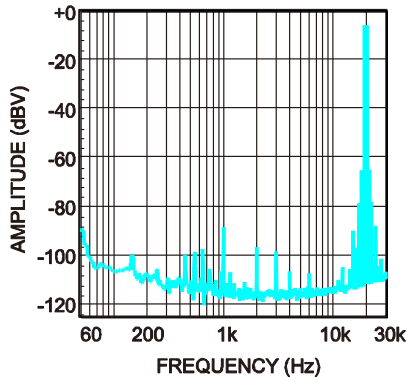

IHF-IMD

$V_{DD} = 30V$, $R_{LOAD} = 8\Omega(SE)$,
Test Tones: 19kHz and 20kHz
Ratio=1:1

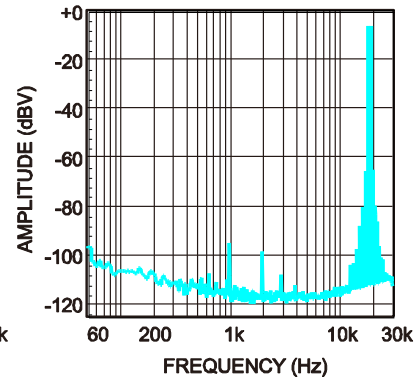

TYPICAL PERFORMANCE CURVES *(continued)*

Circuit of Figure 6, BTL output configuration, $V_{DD}=24V$, $V_{EN}=5V$, $A_V=15V/V$, $T_A = +25^\circ C$, unless otherwise noted.

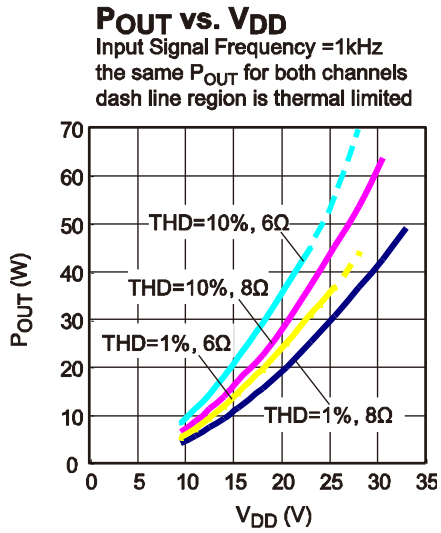
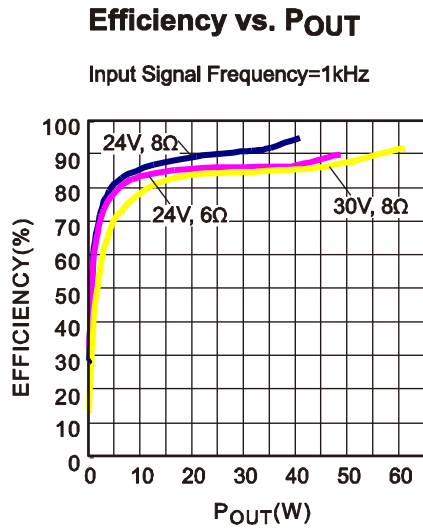

BLOCK DIAGRAM

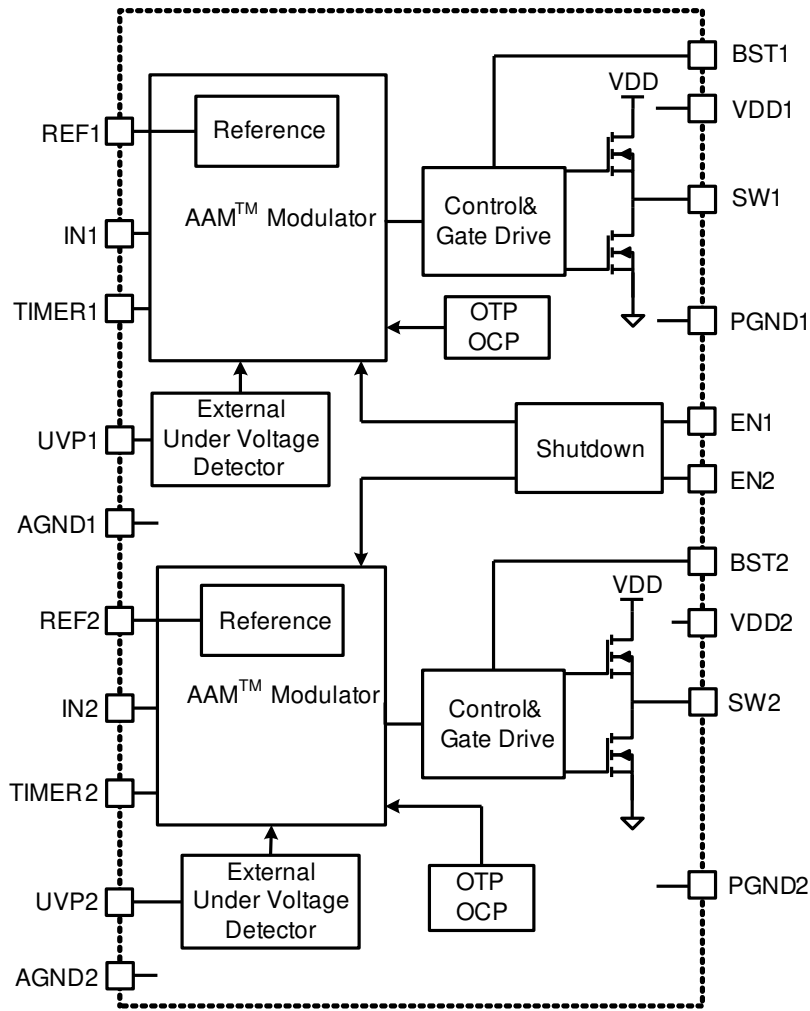

Figure 1—Function Block Diagram

OPERATION

The MP7748S is a Class D Audio Amplifier for driving stereo speakers in single-ended configuration or a mono speaker in bridge-tied-load configuration. It uses the Monolithic Power Systems patented Analog Adaptive Modulation™ to convert the audio input signal into pulses. These pulses drive an internal high-current output stage and, when filtered through an external inductor-capacitor filter, reproduce the input signal across the load. Because of the switching Class D output stage, power dissipation in the amplifier is drastically reduced when compared to Class A, B or A/B amplifiers while maintaining high fidelity and low distortion.

REF1 and REF2 are the positive inputs of the two amplifiers. They are set to half the DC power supply input voltage ($V_{DD}/2$) by the internal circuit. The input capacitor C_{IN} couple the AC signal at the input.

The amplifier voltage gain is set by the combination of the input resistor R_{IN} and the feedback resistor R_{FB} and is calculated by the equation:

$$AV = \frac{-R_{FB}}{R_{IN}}$$

Where: for Channel 1, $R_{FB}=R_{FB1}$, $R_{IN}=R_{IN1}$;

For Channel 2, $R_{FB}=R_{FB2}$, $R_{IN}=R_{IN2}$.

The MP7748S includes four high-power MOSFETs wherein for each channel the output driver stage uses two 200mΩ N-channel MOSFETs to deliver the pulses to the LC output filter which in turn drives the load. To fully enhance the high-side MOSFET, the gate is driven to a voltage higher than the source by the bootstrap capacitor between SW and BS. While the output is driven low, the bootstrap capacitor is charged from V_{DD} through an internal circuit on the MP7748S. The gate of the high-side MOSFET is driven high from the voltage at BS, forcing the MOSFET gate to a voltage higher than V_{DD} and allowing the MOSFET to fully turn on, reducing power loss in the amplifier.

Pop Elimination

The MP7748S integrates a source current function to charge the AC coupling capacitor $C_{OUT1/2}$ for the SE output configuration and $C_{IN1/2}$ at the start up moment. The start up source current slew rate is adjustable by selecting different capacitance of timer capacitor $C_{TIMER1/2}$. The larger the capacitance of the timer capacitor is, the smaller the start up current slew rate is. The recommended 1μF timer capacitor results in a start up current slew rate of approximately 20mA/350ms which would help to minimize the turn on pop.

After driving EN pin low, output SW will be set to high impedance immediately which would help to eliminate the turn off pop.

Short Circuit/Overload Protection

The MP7748S has internal overload and short circuit protection. The currents in both the high-side and low-side MOSFETs are measured and if the current exceeds the 5.5A short circuit current limit, both MOSFETs are turned off. The MP7748S then restarts with the same power up sequence that is used for normal starting to prevent a pop from occurring after a short circuit condition is removed.

Over-Temperature Shutdown

Thermal monitoring is also integrated into the MP7748S. If the die temperature rises above 150°C, all switches turn off. The temperature must fall below 120°C before normal operation resumes, with the same power-up sequence used to prevent popping noise.

Enable Function

The MP7748S EN input is an active high enable control. To enable the MP7748S, drive EN with a 2.0V or higher voltage. To disable the amplifier, drive it below 0.4V. While the MP7748S is disabled, the V_{DD} operating current is around 100μA and the output driver MOSFETs are turned off.

Programmable UVP

MP7748S integrate programmable UVP function, which can be used to shutdown the MP7748S to escape the pop, by controlling the UVP node voltage. The VDD shutdown voltage can be flexibly adjusted by the external resistor, as shown in the figure 2.

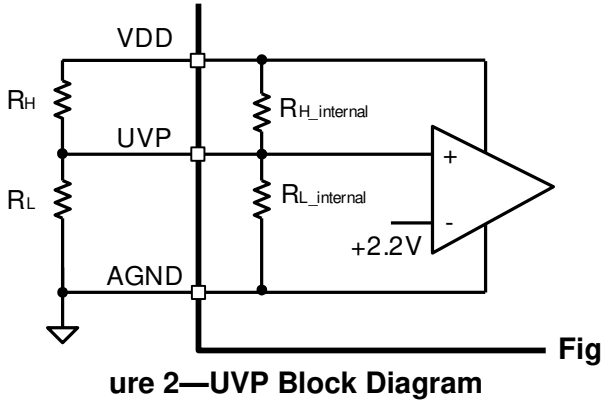

If external resistor R_H and R_L is low enough (e.g. $R_H, R_L < 50k\Omega$) compared with internal resistor, the VDD shutdown voltage (rising threshold) can be calculated by the equation:

$$V_{VDD_shutdown} \approx 2.2 * \frac{(R_H + R_L)}{R_L}$$

If the UVP pin is NC, the default VDD shutdown voltage (rising threshold) is 8.4V since there is internal voltage divided circuit.

For example, please see the table 1 for recommended UVP setting for reduce the power off pop.

Table 1: Recommended R_H and R_L for proper UVP setting.

VDD (V)	VDD_shutdown (V)	R_H	R_L
12	8.6	15k	5.1k
24	19	39k	5.1k
36	26	56k	5.1k

APPLICATION INFORMATION

Component Selection

The MP7748S uses a minimum number of external components to complete a stereo SE or mono BTL Class D audio amplifier. The circuit in Figure 5 (stereo SE application circuit) and Figure 6 (mono BLT application circuit) are optimized for a 30V power supply. This circuit should be suitable for most applications. Use the following sections to design custom circuits.

Setting the Voltage Gain

The maximum output-voltage swing is limited by the power supply. To achieve the maximum output power, set the gain such that the maximum input signal results in the maximum output voltage swing.

For a single-ended (SE) output configuration, the maximum output voltage $V_{OUT(PK)}$ is $V_{DD}/2$. For a bridge-tied-load (BTL) output configuration, the maximum output voltage $V_{OUT(PK)}$ is V_{DD} . For a given input signal voltage, where $V_{IN(PK)}$ is the peak input voltage, the maximum voltage gain is:

$$A_V(MAX) = \frac{V_{OUT(PK)}}{V_{IN(PK)}}$$

This voltage-gain setting results in the peak output voltage approaching its maximum for the maximum input signal. In some cases the amplifier is allowed to overdrive slightly, allowing the THD to increase at high power levels, and so a higher gain than $A_V(max)$ is required.

Setting the Switching Frequency

The idle switching frequency (the switching frequency when no audio input is present) is a function of several variables: The supply voltage V_{DD} , the integral capacitor C_{INT} and the feedback resistor R_{FB} . Lower switching frequencies result in greater inductor ripple, causing more quiescent output voltage ripple, and increasing the output noise and distortion. Higher switching frequencies result in greater power loss. The optimum quiescent switching frequency is approximately 600kHz. When used to drive stereo speakers in single-ended configuration, set right channel to an idle switching frequency greater than 50kHz plus the left channel's

switching frequency by using a different timing capacitor C_{INT} . For details, refer to the Table for recommended SE output configuration design, and Table 3 for recommended BTL output configuration design.

Table 2: Switching Frequency Setting For SE Output Configuration

V_{DD} (V)	Gain (V/V)	R_{FB} (k Ω)	R_{IN} (k Ω)	Left channel		Right channel	
				C_{INT1} (nF)	F_{SW1} (kHz)	C_{INT2} (nF)	F_{SW2} (kHz)
12	10	100	10	1.8	694	1.5	774
12	20	100	4.99	1.8	694	1.5	782
24	10	150	15	2.7	653	2.2	720
24	20	150	7.5	2.7	654	2.2	723
24	30	150	4.99	2.7	657	2.2	723
30	10	150	15	3.3	653	2.7	743
30	20	150	7.5	3.3	654	2.7	745
30	30	150	4.99	3.3	659	2.7	747
36	10	150	15	5.6	588	3.9	665
36	20	150	7.5	5.6	590	3.9	667
36	30	150	4.99	5.6	592	3.9	670

Table 3: Switching Frequency Setting for BTL Output Configuration

V_{DD} (V)	Gain (V/V)	R_{FB} (k Ω)	R_{IN} (k Ω)	C_{INT} (nF)	F_{SW} (kHz)
12	10	100	10	1.0	686
12	20	100	4.99	1.0	693
24	10	150	15	1.0	660
24	20	150	7.5	1.0	669
24	30	150	4.99	1.0	674
30	10	150	15	1.2	670
30	20	150	7.5	1.2	672
30	30	150	4.99	1.2	677

Choosing the Output LC Filter

The inductor-capacitor (LC) filter converts the pulses at SW to the output voltage that drives the speaker. There are two kinds of LC filter structure depending on the output configuration.

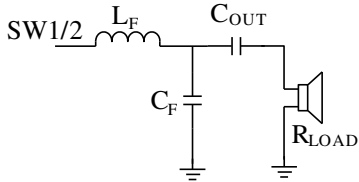

Figure 3: SE Filter Configuration

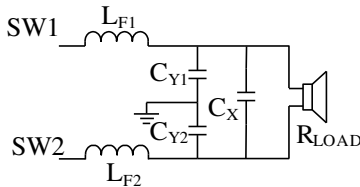

Figure 4: BTL Filter Configuration

Where:

$$L_F = L_{F1} + L_{F2},$$

$$C_F = C_X + \frac{C_{Y1} \times C_{Y2}}{C_{Y1} + C_{Y2}},$$

$$L_{F1} = L_{F2};$$

$$C_{Y1} = C_{Y2}$$

The characteristic frequency of the LC filter needs to be high enough to allow high frequency audio to the output, yet needs to be low enough to filter out high frequency products of the pulses from the SW pin. The characteristic frequency of the LC filter is:

$$f_0 = \frac{1}{2 \times \pi \times \sqrt{L_F \times C_F}}$$

The quality factor (Q) of the LC filter is important: If this is too low, output noise will increase; if this is too high, then peaking may occur at high frequencies and reduce the passband flatness. The circuit Q is set by the load resistance (speaker resistance, typically 4Ω or 8Ω). Q is calculated as:

$$Q = \frac{R_{LOAD}}{\omega_0 \times L_F} = \frac{R_{LOAD}}{2\pi \times f_0 \times L_F}$$

ω_0 is the characteristic frequency in radians/second and f_0 is in Hz. Use an LC filter with Q between 0.7 and 1.

The type of inductor and capacitor used in the LC filter greatly affects the output ripple and noise. Use a film capacitor and an inductor with sufficient power rating to supply the output current to the load. The inductor must exhibit soft saturation characteristics: If the inductor exhibits hard saturation, it should operate well below the saturation current. Use toroidal cores made of gapped ferrite, MPP, powdered iron, or similar materials. If using either an open or shielded bobbin ferrite core for multi-channel designs, make sure that the start windings of each inductor align (all starting toward the SW pin, or all starting toward the output) to prevent crosstalk or other channel-to-channel interference.

Output Coupling Capacitor for SE Output

The output AC coupling capacitor— C_{OUT} —serves to pass only the amplified AC signal from the LC filter to the load and to block DC signals. The combination of the coupling capacitor, C_{OUT} and the load resistance results in a first-order high-pass filter. Select C_{OUT} so that the required minimum frequency passes. The output corner frequency (-3dB point), f_{OUT} , can be calculated as:

$$f_{OUT} = \frac{1}{2 \times \pi \times R_{LOAD} \times C_{OUT}}$$

Set the output corner frequency (f_{OUT}) at or below the minimum required frequency.

The output coupling capacitor carries the full load current, so chose a capacitor such that its ripple current rating is greater than the maximum load current. Use low-ESR aluminum electrolytic capacitors for best results.

Input Coupling Capacitor

The input coupling capacitors C_{IN1} and C_{IN2} pass only the AC signal at the input. For a typical system application, the source input signal centers around the circuit ground, while the MP7748S input is at half the power supply voltage ($V_{DD}/2$). The input coupling capacitor transmits the AC signal from the source

to the MP7748S while blocking the DC voltage. Choose an input coupling capacitor such that the corner frequency (f_{IN}) is less than the passband frequency. The corner frequency is calculated as:

$$f_{IN} = \frac{1}{2 \times \pi \times R_{IN} \times C_{IN}}$$

Timer capacitor

The start-up source current slew rate is related to the timing capacitor C_{TIMER} and SW voltage: The higher SW voltage is, the smaller charge current slew rate is. The larger the C_{TIMER} capacitance is, the longer the start-up time is. Select a C_{TIMER} value larger than 312nF, so the start-up current slew rate would be small which helps eliminate the turn-on pop. The recommended 1 μ F capacitor C_{TIMER} results in a start-up current slew rate of approximately 20mA/350ms.

Power Source

For maximum output power, the amplifier circuit requires a regulated external power source. A high power-supply voltage can deliver more power to a given load resistance, but a power-source voltage exceeding the maximum voltage of 36V can damage the MP7748S. The MP7748S's power supply rejection is excellent, though power-supply noise can pass to the output, so care must be taken to minimize power supply noise within the pass-band frequencies. Bypass the power supply with a large capacitor (typically aluminum electrolytic) along with a smaller 1 μ F ceramic capacitor at the MP7748S V_{DD} supply pins.

PCB Layout

Circuit layout is critical for optimal performance, low output distortion, and noise. Duplicate the EVB layout for best results. For layout changes, follow these guidelines and use Figure 7 and Figure 8 as references.

1) Place the following components as close to the MP7748S as possible:

Bootstrap Capacitors

C_{BS1} and C_{BS2} supply the gate drive current to the internal HS-FET. Place C_{BS1} as close to BST1/2 pin and SW1/2 pin as possible.

Likewise, place C_{BS2} as close to BST2 pin and SW2 pins as possible.

Power Supply Bypass Capacitors

C_{BYP1} and C_{BYP2} carry the transient current for the switching power stage. To avoid overstressing the MP7748S and excessive output noise, place C_{BYP1} as close to the VDD1 pins and PGND1 pins as possible, and place C_{BYP2} as close to the VDD2 pins and PGND2 pins as possible.

Integral Capacitors

C_{INT} sets the amplifier switching frequencies and are typically on the order of a few nF. Place the integral capacitor C_{INT} as close to the corresponding input as possible to reduce distortion and noise. For example, place C_{INT1} as close to pins 2 and 3 as possible at SE output configuration.

Reference Bypass Capacitors for SE Output

When used with SE output, CR1 and CR2 filter the $\frac{1}{2}$ VDD reference voltages. Place C_{R1} and C_{R2} as close to the IC as possible to improve power supply rejection and reduce distortion and noise at the output.

2) The Inductor-Capacitor (LC) filter converts the pulse train at SW to the output voltage that drives the speaker. Please keep the filter capacitor close to the inductor.

3) When laying out the PCB, use two separate ground planes—analogue ground (AGND) and power ground (PGND)—and connect the two grounds together at a single point (usually around the bulk bypass capacitor) to prevent noise injection into the amplifier input to reduce distortion.

4) Keep the sensitive feedback signal trace on the input side and shield the trace with the AGND plane. Make sure that any traces carrying the switch node (SW) voltages are routed far from any input signal traces. If the trace must run near the SW trace near the input, shield the input with a ground plane between the traces. Physically separate each channel to prevent crosstalk. Make sure that all inductors used on a single circuit board have the same orientation.

Route each power supply from the source to each channel individually, not serially. This prevents channel-to-channel coupling through the power supply input.

Electro-Magnetic Interference (EMI) Considerations

Due to the switching nature of Class D amplifiers, care must be taken to minimize the effects of electromagnetic interference from the amplifier. However, proper component selection and careful attention to circuit layout can minimize the effects of the EMI due to the amplifier switching.

The power inductors are a potential source of radiated emissions. For the best EMI performance, use toroidal inductors, since the magnetic field is well-contained inside the core.

However toroidal inductors can be expensive to wind. For a more economical solution, use shielded-gapped-ferrite or shielded-ferrite-bobbin-core inductors. These inductors typically do not contain the EM field as well toroidal inductors, but can achieve a better balance between good EMI performance with low cost.

The size of high-current loops that carry rapidly changing currents must be minimized: Make sure that the V_{DD} bypass capacitors are as close to the MP7748S as possible.

Nodes that carry rapidly changing voltage, such as SW, need to be made as small as possible. If sensitive traces run near a trace connected to SW, place a ground shield between the traces.

TYPICAL APPLICATION CIRCUITS

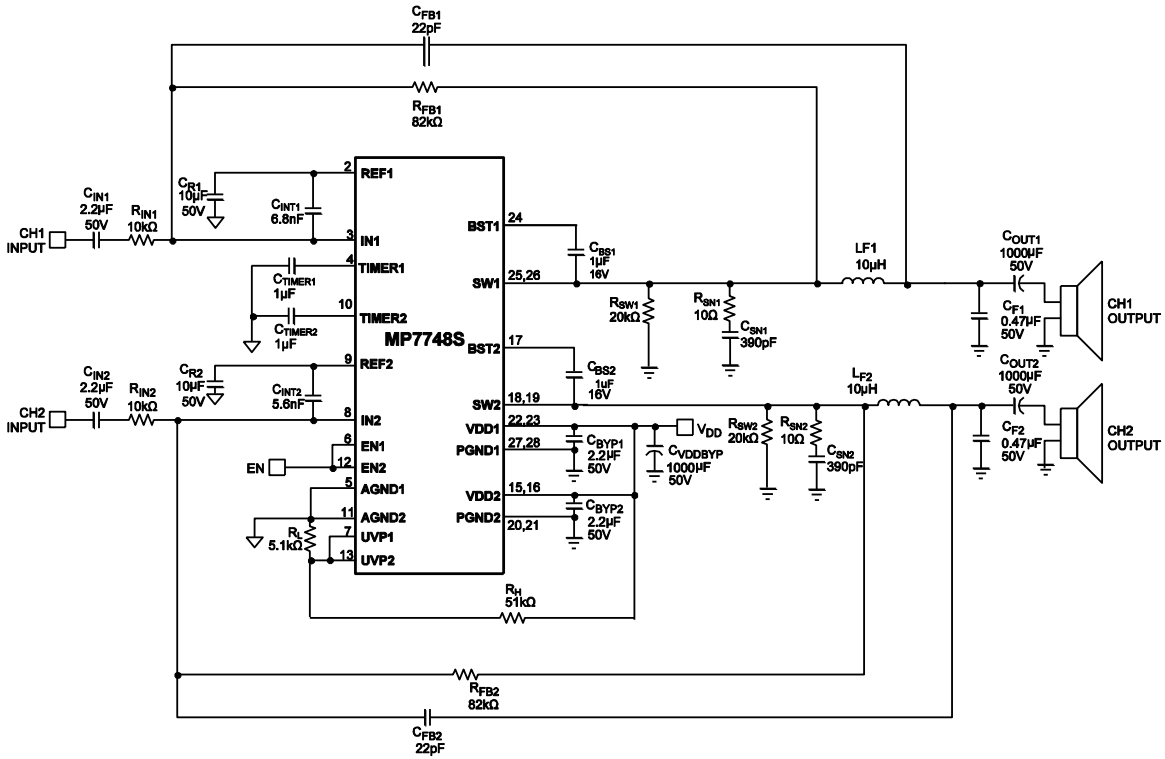

Figure 5—30V VDD Stereo SE Typical Application Circuit

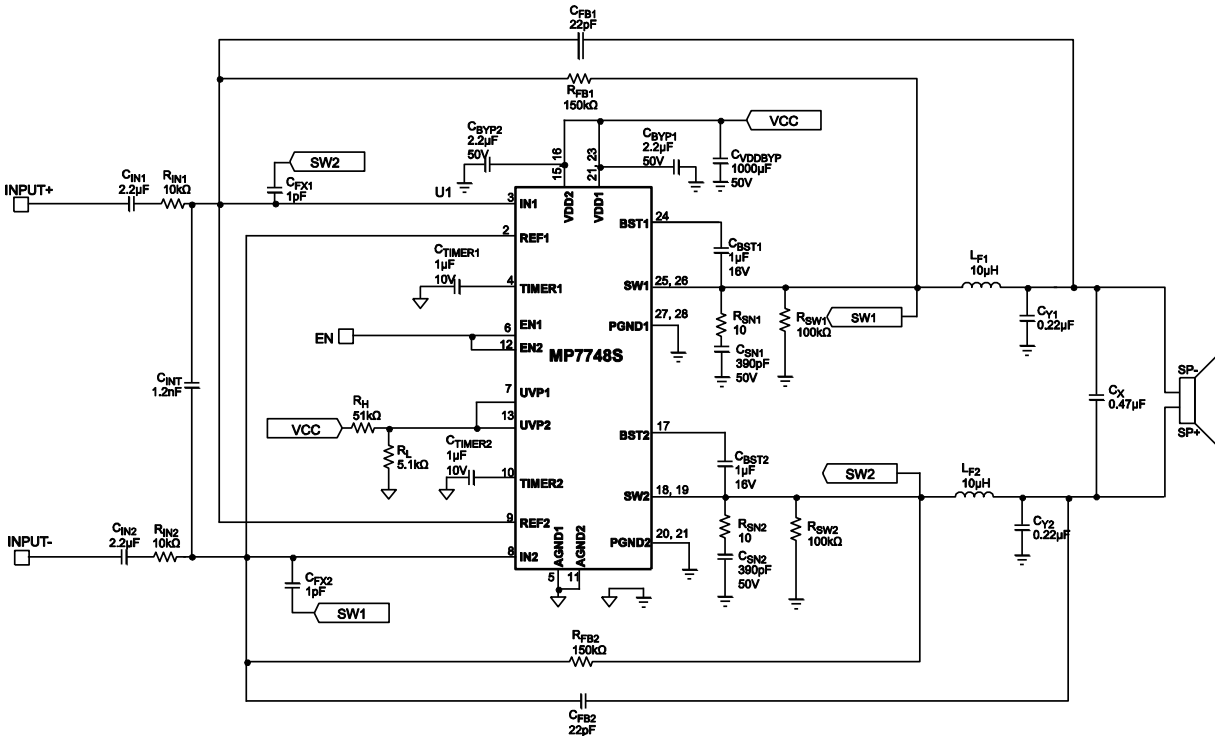

Figure 6—30V VDD mono BTL Typical Application Circuit

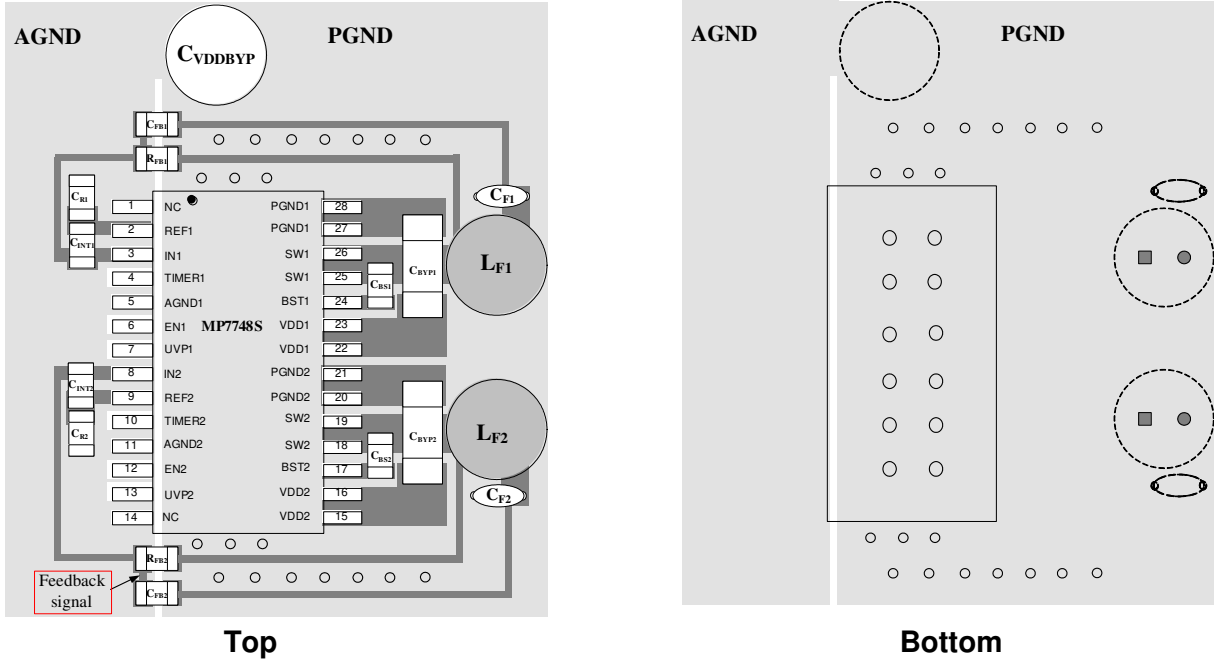

Figure 7—Stereo SE Reference PCB Layout

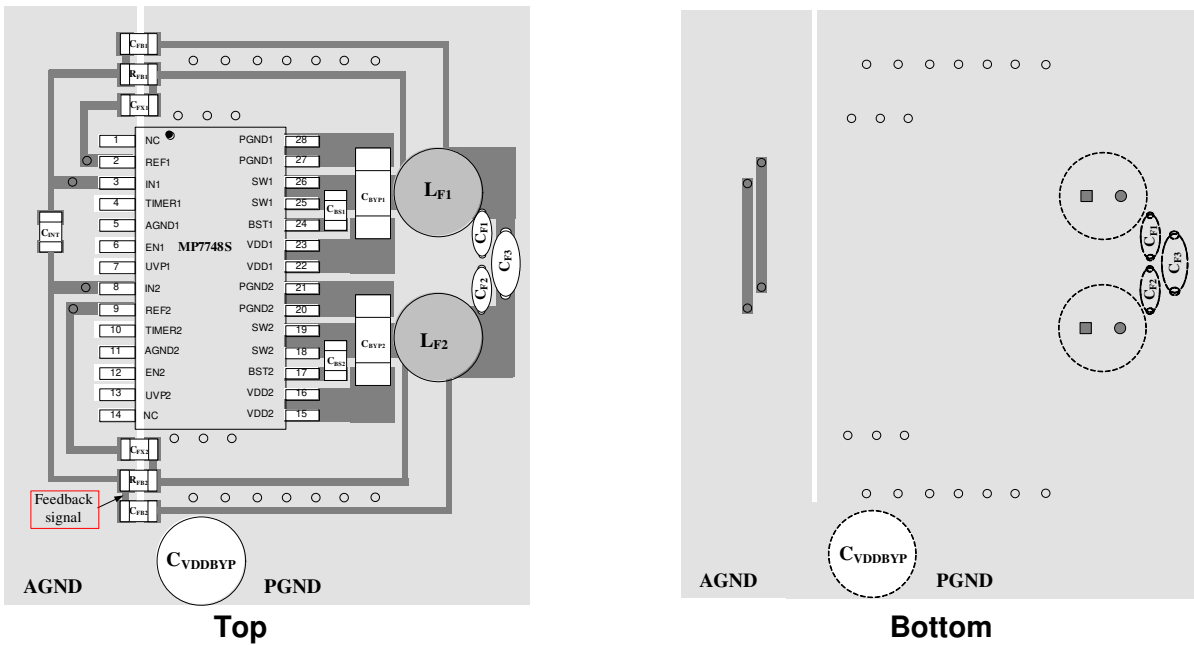
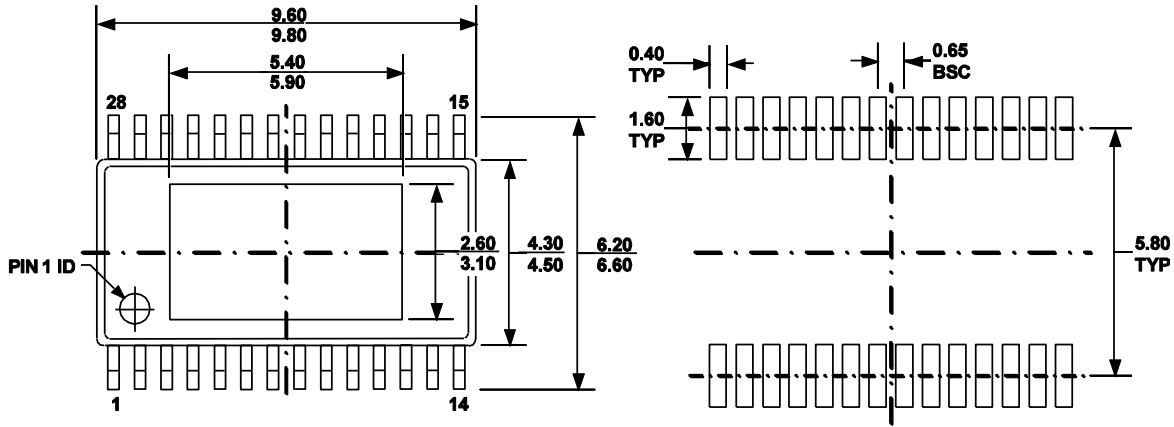

Figure 8—Mono BTL Reference PCB Layout

PACKAGE INFORMATION

TSSOP28-EP



TOP VIEW

RECOMMENDED LAND PATTERN

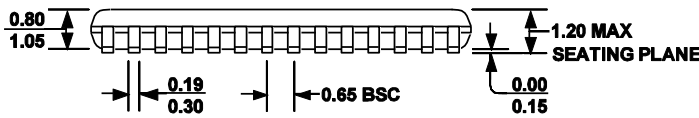

FRONT VIEW

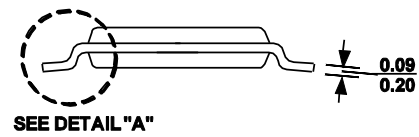

SIDE VIEW

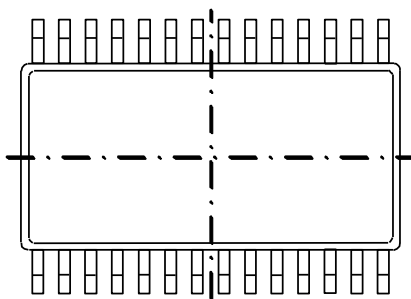

BOTTOM VIEW

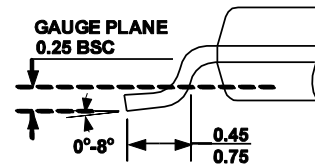

DETAIL "A"

NOTE:

- 1) ALL DIMENSIONS ARE IN MILLIMETERS
- 2) PACKAGE LENGTH DOES NOT INCLUDE MOLD FLASH, PROTRUSION OR GATE BURR.
- 3) PACKAGE WIDTH DOES NOT INCLUDE INTERLEAD FLASH OR PROTRUSION.
- 4) LEAD COPLANARITY (BOTTOM OF LEADS AFTER FORMING) SHALL BE 0.10 MILLIMETERS MAX
- 5) JEDEC REFERENCE IS MO-153.
- 6) DRAWING IS NOT TO SCALE

NOTICE: The information in this document is subject to change without notice. Users should warrant and guarantee that third party Intellectual Property rights are not infringed upon when integrating MPS products into any application. MPS will not assume any legal responsibility for any said applications.