



Chipsmall Limited consists of a professional team with an average of over 10 year of expertise in the distribution of electronic components. Based in Hongkong, we have already established firm and mutual-benefit business relationships with customers from,Europe,America and south Asia,supplying obsolete and hard-to-find components to meet their specific needs.

With the principle of “Quality Parts,Customers Priority,Honest Operation,and Considerate Service”,our business mainly focus on the distribution of electronic components. Line cards we deal with include Microchip,ALPS,ROHM,Xilinx,Pulse,ON,Everlight and Freescale. Main products comprise IC,Modules,Potentiometer,IC Socket,Relay,Connector.Our parts cover such applications as commercial,industrial, and automotives areas.

We are looking forward to setting up business relationship with you and hope to provide you with the best service and solution. Let us make a better world for our industry!



Contact us

Tel: +86-755-8981 8866 Fax: +86-755-8427 6832

Email & Skype: info@chipsmall.com Web: www.chipsmall.com

Address: A1208, Overseas Decoration Building, #122 Zhenhua RD., Futian, Shenzhen, China



DESCRIPTION

The MP8049S is a configurable dual channel full-bridge or quad channel half-bridge that can be configured as the output stage of a Class-D audio amplifier. Each full-bridge can be driven independently as stereo single ended audio amplifiers or driven complementarily in a bridge tied load (BTL) audio amplifier configuration.

The MP8049S features a low current shutdown mode, standby mode, input under voltage protection, current limit, thermal shutdown and fault flag signal output. All channels of drivers interface with standard logic signals.

The MP8049S is available in a 40 lead QFN 5X5 package.

FEATURES

- 5V to 26V VDD
- ±5.5A Peak Current Output
- Up to 1MHz Switching Frequency
- Protected Integrated Power 0.14Ω Switches
- 10ns Switch Dead Time
- All Switches Current Limited
- Internal Under Voltage Protection
- Internal Thermal Protection
- Short-circuit Protection
- Fault Output Flag
- Bridge Tied Load Output Power: 37W/Channel at 24V, 8Ω

APPLICATIONS

- Flat TV
- Home Theaters
- DVD Receivers

All MPS parts are lead-free and adhere to the RoHS directive. For MPS green status, please visit MPS website under Products, Quality Assurance page.

"MPS" and "The Future of Analog IC Technology" are registered trademarks of Monolithic Power Systems, Inc.

TYPICAL APPLICATION

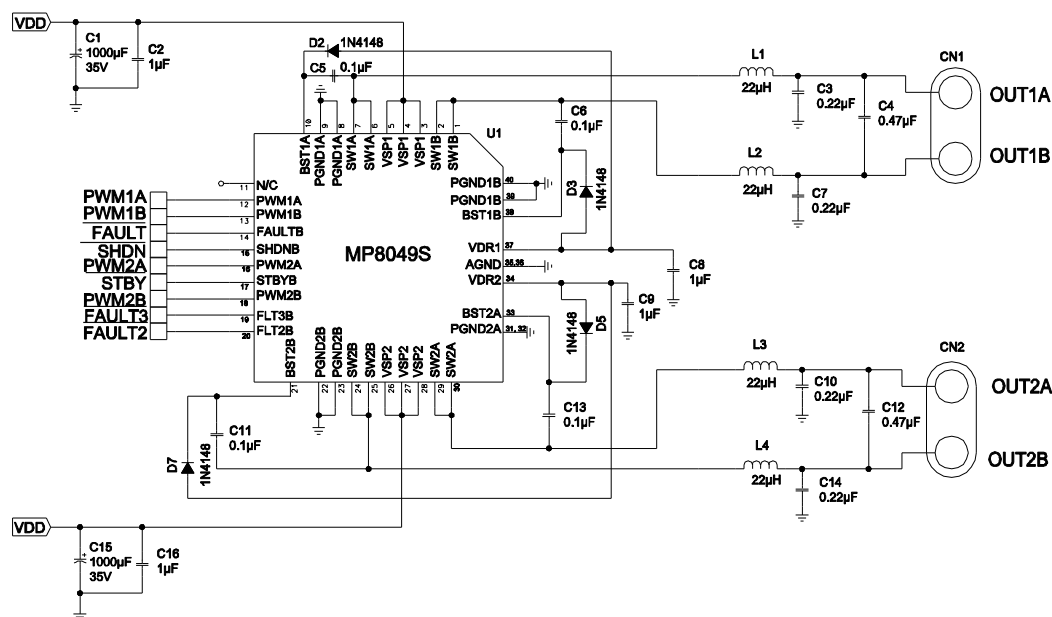

ORDERING INFORMATION

Part Number*	Package	Top Marking
MP8049SDU	QFN40 (5x5mm)	MP8049S

* For Tape & Reel, add suffix -Z (e.g. MP8049SDU-Z).
 For RoHS Compliant Packaging, add suffix -LF (e.g. MP8049SDU-LF-Z)

PACKAGE REFERENCE

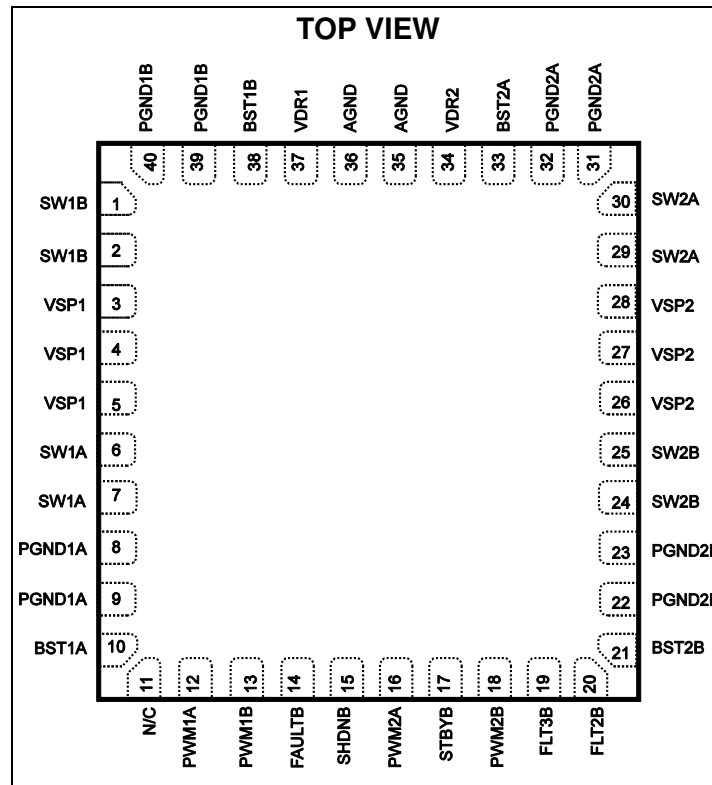

ABSOLUTE MAXIMUM RATINGS ⁽¹⁾

VSP Supply Voltage28V
 SW1/2 Pin Voltage.....-0.3V to $V_{DD} + 0.3V$
 SW1/2 to BST1/2 -0.3V to +6V
 Voltage at All Other Pins..... -0.3V to +6V
 Continuous Power Dissipation.. ($T_A = +25^\circ C$) ⁽²⁾
4.2W
 Storage Temperature..... -55°C to +150°C
 Junction Temperature 150°C
 Lead Temperature 260°C

Recommended Operating Conditions ⁽³⁾

VSP Supply Voltage 5V to 26V
 Operating Junction Temp. (T_J) . -40°C to +125°C

Thermal Resistance ⁽⁴⁾ θ_{JA} θ_{JC}
 QFN40 (5 x 5mm) 36 8.... °C/W

Notes:

- 1) Exceeding these ratings may damage the device.
- 2) The maximum allowable power dissipation is a function of the maximum junction temperature $T_J(MAX)$, the junction-to-ambient thermal resistance θ_{JA} , and the ambient temperature T_A . The maximum allowable continuous power dissipation at any ambient temperature is calculated by $P_D(MAX) = (T_J(MAX) - T_A) / \theta_{JA}$. Exceeding the maximum allowable power dissipation will cause excessive die temperature, and the regulator will go into thermal shutdown. Internal thermal shutdown circuitry protects the device from permanent damage.
- 3) The device is not guaranteed to function outside of its operating conditions.
- 4) Measured on JESD51-7, 4-layer PCB.

ELECTRICAL CHARACTERISTICS

$V_{SP} = 12V$, $V_{SHDNB} = 5V$, $T_A = +25^{\circ}C$, unless otherwise specified.

Parameters	Symbol	Condition	Min	Typ	Max	Units
VSP Operating Current		$I_{LOAD} = 0A$, $PWM_{1,2}=0$		2.2	3.5	mA
VSP Shutdown Current		$V_{SHDN} = 0V$		24	30	μA
Operating VSP Threshold Low			3.7	4		V
Operating VSP Threshold High				4.4	4.8	V
STBYB Threshold Low			0.8	1.0		V
STBYB Threshold High				1.6	1.8	V
PWM Input Bias Current				0.1	1.0	μA
SHDNB Threshold Low			0.8	1.0		V
SHDNB Threshold High				1.6	1.8	V
PWM _{1,2} Threshold Low			0.8	1		V
PWM _{1,2} Threshold High				1.6	1.8	V
SW1/2 On Resistance ⁽⁵⁾		$V_{SP} = 7V$, High-Side and Low-Side		0.14		Ω
SW1/2 Current Limit ⁽⁵⁾		$V_{PWM} = 0V$, Sinking		5.5		A
		$V_{PWM} = 5V$, Sourcing		5.5		A
SW1/2 Switching Frequency		$V_{PWM} = 0$ to 5V, 50% Duty Cycle			1	MHz
BST Voltage UVLO		falling value		2.2		V
BST Current		High-Side MOSFET on, V_{BST-} $V_{SW}=5.5V$		30		μA
SW1/2 Rise/Fall Time ⁽⁵⁾		$V_{PWM} = 0V$ to 5V		5		ns
Minimum PWM Pulse Width		$V_{PWM} = 0V$ to 5V, High or Low Pulse		30		ns
Dead Time ⁽⁵⁾		$I_{OUT} = \pm 100mA$		10		ns
PWM _{1,2} to SW _{1,2} Delay Time Rising		$V_{PWM} = 0V$ to 5V		30		ns
PWM _{1,2} to SW _{1,2} Delay Time Falling		$V_{PWM} = 5V$ to 0V		30		ns
Thermal Shutdown Temperature ⁽⁵⁾		T_J Rising		160		$^{\circ}C$
Thermal Shutdown Hysteresis				35		$^{\circ}C$

Notes:

5) Not production tested.

OPERATING SPECIFICATIONS ⁽⁶⁾

$V_{SP} = 18V$, $V_{SHDNB} = 5V$, $V_{STBYB} = 5V$, Bridge-tied-load output configuration, $T_A = +25^{\circ}C$, unless otherwise specified.

Parameters	Symbol	Condition	Min	Typ	Max	Units
Power Output	P_O	$V_{SP}=18V$, $f = 1kHz$, $THD+N < 1\%$, $R_L = 6\Omega$		20		W
		$V_{SP}=24V$, $f = 1kHz$, $THD+N < 1\%$, $R_L = 8\Omega$		30		W
THD+ Noise		$V_{SP}=18V/24V$, $f = 1kHz$, $P_O = 1W$, $R_L = 8\Omega/6\Omega$		0.1		%
Efficiency		$V_{SP}=24V$, $f = 1kHz$, $P_O = 35W$, 8Ω Load		92		%
SNR		$P_O=15W$, $R_L = 8\Omega/6\Omega$, A-Weighted		100		dB
Noise Floor		A-Weighted		100		μV
Cross Talk				-80		dB
Power Supply Rejection		$V_{RIPPLE}=200mV_{PP}$ $C_{SP}=1\mu F$	$f = 1k Hz$		-70	dB
			$f = 217 Hz$		-70	dB

Note:

6) Operating Specifications are for the IC in Typical Application circuit.

PIN FUNCTIONS

Pin #	Name	Description
1,2	SW1B	Switched Output 1B. Connect the output LC filter to SW1B. SW1B is valid approximately 100µs after VSP goes high.
3,4,5	VSP1	Power Supply Input. Connect VSP1 to the positive side of the input power supply. Bypass VSP1 to PGND as close to the IC as possible.
6,7	SW1A	Switched Output 1A. Connect the output LC filter to SW1A. SW1A is valid approximately 100µs after VSP goes high.
8,9	PGND1A	Power Ground of channel 1A. Connect the exposed pad on bottom side to the ground plane.
10	BST1A	Bootstrap Supply. BST1A powers the high-side gate of the SW1A stage. Connect a 0.1µF or greater capacitor between BST1A and SW1A.
11	N/C	No connect.
12	PWM1A	Driver Logic Input 1A. Drive PWM1 with the signal that controls the MP8049S SW1A. Drive PWM high to turn on the high side switch; drive PWM low to turn on the low-side switch.
13	PWM1B	Driver Logic Input 1B. Drive PWM1 with the signal that controls the MP8049S SW1B. Drive PWM high to turn on the high side switch; drive PWM low to turn on the low-side switch.
14	FAULTB	Fault Output. A low output at $\overline{\text{FAULT}}$ indicates that the MP8049S has detected an over temperature or over current or under voltage condition. This output is open drain.
15	SHDNB	Shutdown Input. When low, the IC will be shut off.
16	PWM2A	Driver Logic Input 2A. Drive PWM2 with the signal that controls the MP8049S SW2A. Drive PWM high to turn on the high side switch; drive PWM low to turn on the low-side switch.
17	STBYB	Standby Input. Default low (internal pull-down). If driven high, the output of the drivers is determined by the PWM1A/1B/2A/2B. If driven low, the output of both drivers is high impedance.
18	PWM2B	Driver Logic Input 2B. Drive PWM2 with the signal that controls the MP8049S SW2B. Drive PWM high to turn on the high side switch; drive PWM low to turn on the low-side switch.
19	FLT3B	Fault monitor pin. Detailed please see the Fault Output section. This output is open drain.
20	FLT2B	Fault monitor pin. Detailed please see the Fault Output section. This output is open drain.
21	BST2B	Bootstrap Supply. BST2B powers the high-side gate of the SW2B stage. Connect a 0.1µF or greater capacitor between BST2B and SW2B.
22, 23	PGND2B	Power Ground of Channel 2B. Connect the exposed pad on the bottom side to the ground plane.
24, 25	SW2B	Switched Output 2B. Connect the output LC filter to SW2B. SW2B is valid approximately 100µs after VSP goes high.
26,27, 28	VSP2	Power Supply Input. Connect VSP2 to the positive side of the input power supply. Bypass VSP2 to PGND as close to the IC as possible.
29, 30	SW2A	Switched Output 2A. Connect the output LC filter to SW2A. SW2A is valid approximately 100µs after VSP goes high.

PIN FUNCTIONS *(continued)*

Pin #	Name	Description
31, 32	PGND2A	Power Ground of channel 2A. Connect the exposed pad on bottom side to the ground plane.
33	BST2A	Bootstrap Supply. BST2A powers the high-side gate of the SW2A stage. Connect a 0.1 μ F or greater capacitor between BST2A and SW2A.
34	VDR2	Gate Drive Supply Bypass. The voltage at VDR2 is supplied from an internal regulator from its respective VSP. VDR2 powers the internal circuitry and internal MOSFET gate drive for its respective SW2 stage. Bypass VDR2 to PGND with a 0.1 μ F to 10 μ F capacitor.
35, 36	AGND	Analog Ground.
37	VDR1	Gate Drive Supply Bypass. The voltage at VDR1 is supplied from an internal regulator from its respective VSP. VDR1 powers the internal circuitry and internal MOSFET gate drive for its respective SW1 stage. Bypass VDR1 to PGND with a 0.1 μ F to 10 μ F capacitor.
38	BST1B	Bootstrap Supply. BST1B powers the high-side gate of the SW1B stage. Connect a 0.1 μ F or greater capacitor between BST1B and SW1B.
39,40	PGND1B	Power Ground of Channel 1B. Connect the exposed pad on bottom side to the ground plane.

TYPICAL PERFORMANCE CHARACTERISTICS

$V_{SP} = 24V$, $V_{SHDNB} = 5V$, $R_{LOAD} = 8\Omega$, Bridge-tied-load output configuration, $T_A = +25^\circ C$, unless otherwise noted.

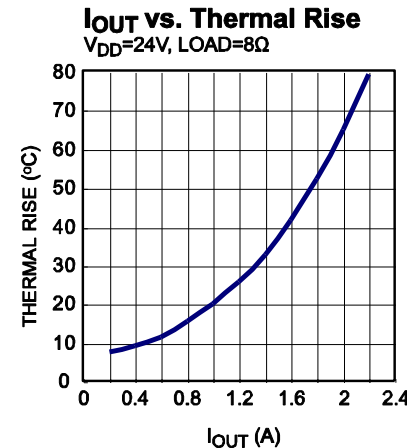
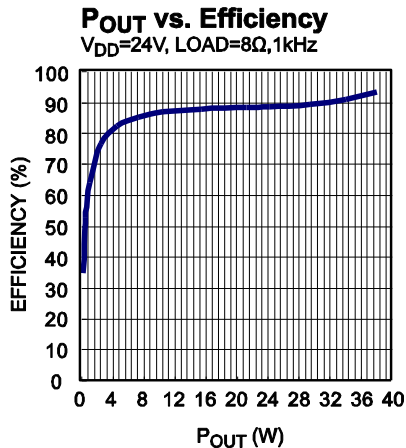
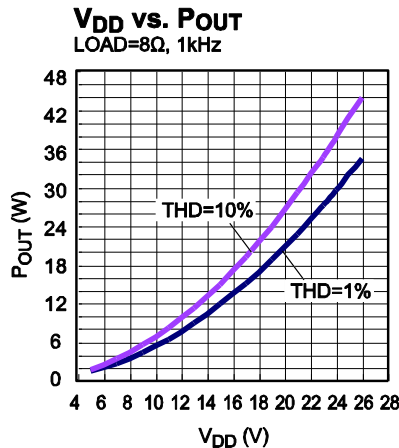
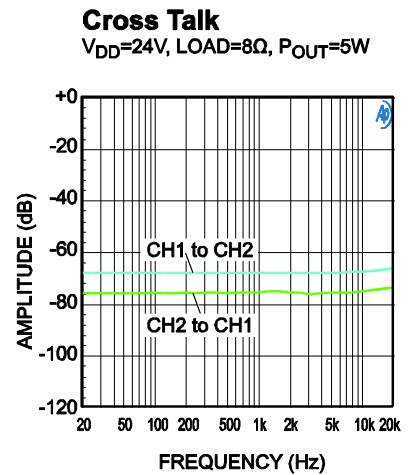
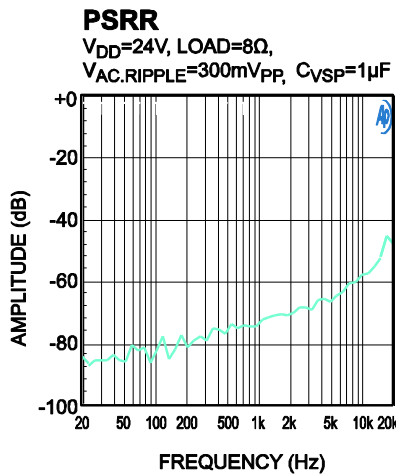
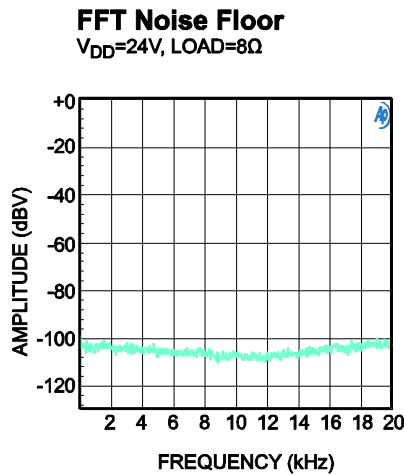
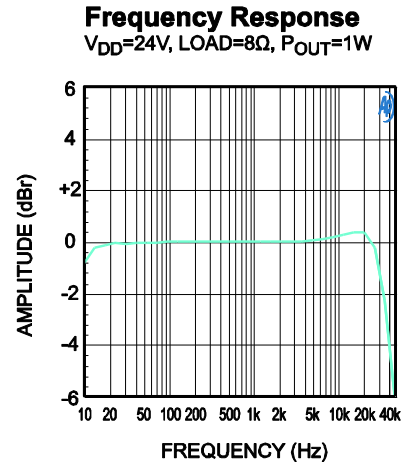
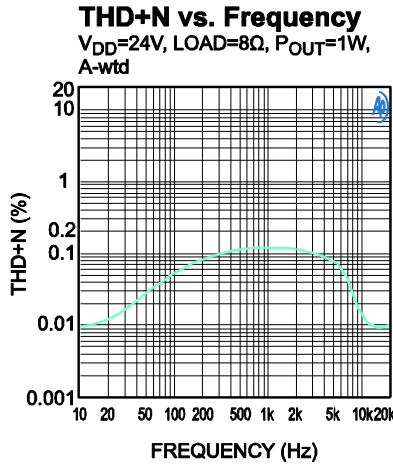
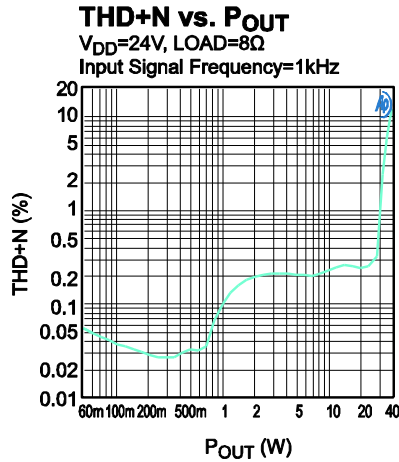

TYPICAL PERFORMANCE CHARACTERISTICS (continued)

$V_{SP} = 18V$, $V_{SHDNB} = 5V$, $R_{LOAD} = 6\Omega$, Bridge-tied-load output configuration, $T_A = +25^\circ C$, unless otherwise noted.

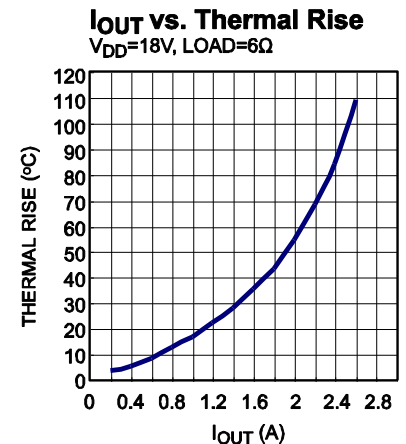
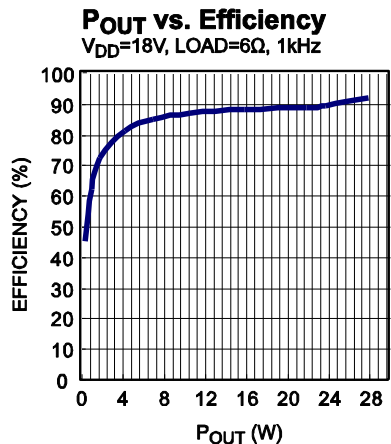
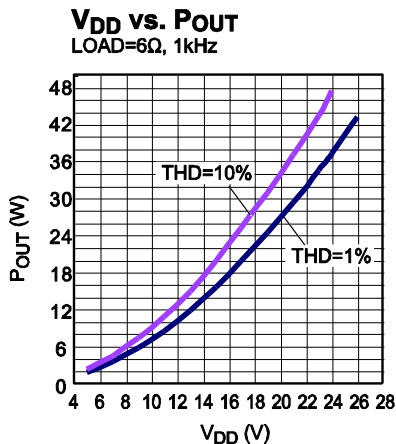
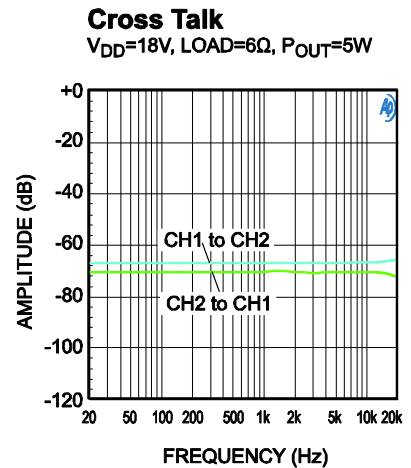
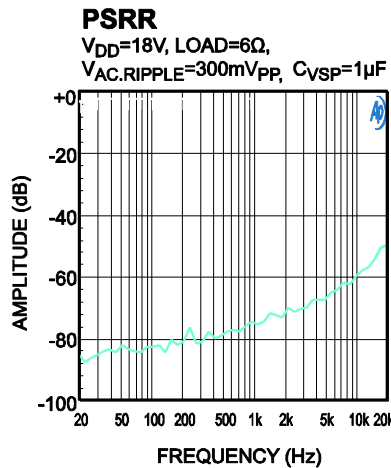
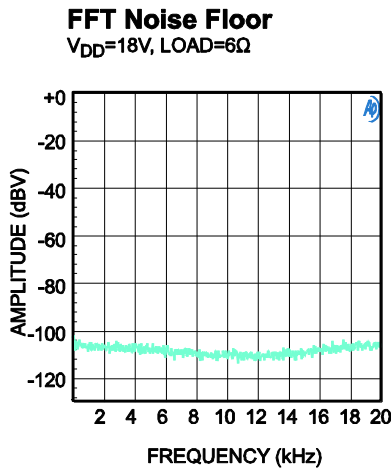
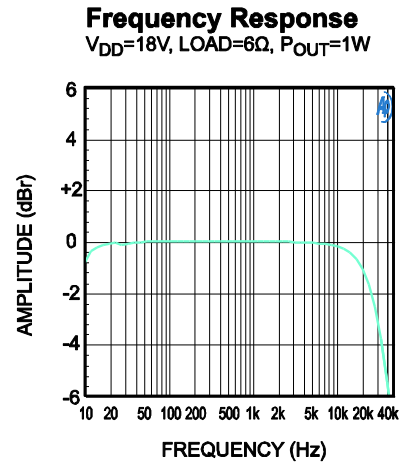
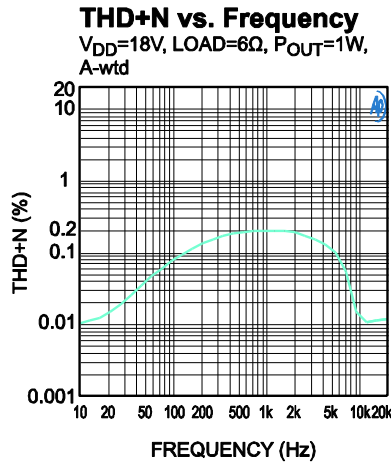
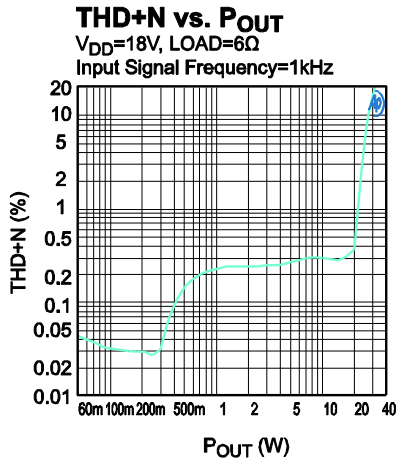

TYPICAL PERFORMANCE CHARACTERISTICS (*continued*)

$V_{SP} = 24V$, $V_{SHDNB} = 5V$, $R_{LOAD} = 8\Omega$, Bridge-tied-load output configuration, $T_A = +25^\circ C$, unless otherwise noted.

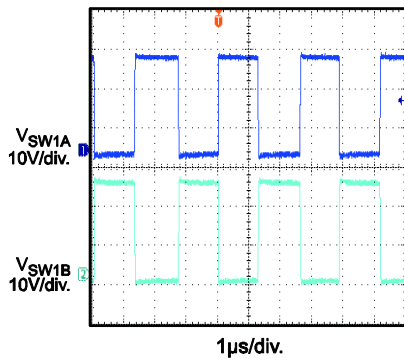
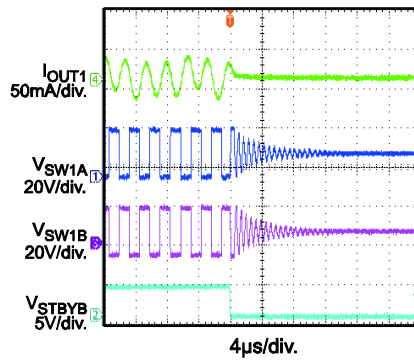
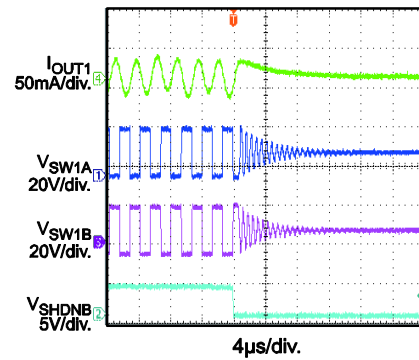
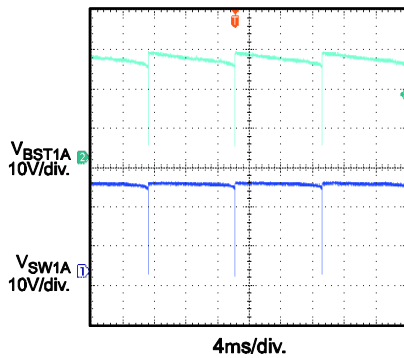
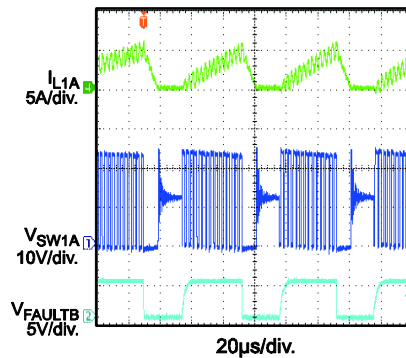
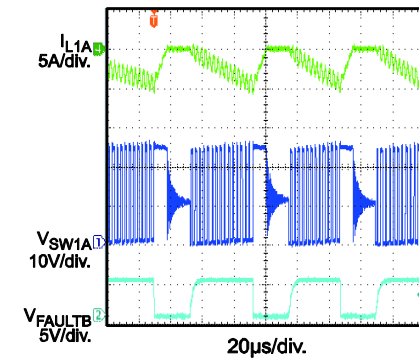
Normal Switch Waveform

Standby

Shutdown

BS Recharge Cycling

Short Circuit Positive Current

Short Circuit Negative Current

OPERATION

The MP8049S is a quad channel power half-bridge driver that can be configured as the output of a Class D amplifier. The output is in phase with the input and the dead time is optimized for symmetrical performance, regardless of load conditions.

When the shutdown (SHDN) pin is low, all channels will be off. When the standby (STBYB) is pulled low, it causes the outputs of all channels to go into high impedance. However, when the voltage across the BST1A/1B/2A/2B and SW1A/1B/2A/2B pins drops sufficiently low, the bottom MOSFET will be turned on to refresh the external bootstrap capacitor. Suggest connect a 0.1 μ F or greater capacitor between BST and SW pins as the bootstrap capacitor.

In order to prevent erratic operation, two under voltage lockout (UVLO) circuits are used. One of them is to ensure that the supply for the bottom gate drive circuit is sufficiently high and the other is for the top gate driver.

Fault Protection

To protect the power MOSFETs, an internal current limit of 5.5A is set for all MOSFETs. When this limit is reached, all four MOSFETs of the over current full bridge channel will go into high impedance for a fixed duration of approximately 30 μ s before resuming normal operation.

Thermal monitoring is also integrated into the MP8049S. If the die temperature rises above 160 $^{\circ}$ C, all switches are turned off. The temperature must fall below 125 $^{\circ}$ C before normal operation resumes.

To enhance the robustness of the device under short circuit condition, a capacitor can be connected to the FaultB pin, as shown in figure 1. The time constant of the RC is selected to be greater than 50ms for the FaultB node to reach 2V. Under short circuit condition, the FaultB node will be reset to zero and the part will be place in standby mode until the voltage at the STBYB pin is above 2V.

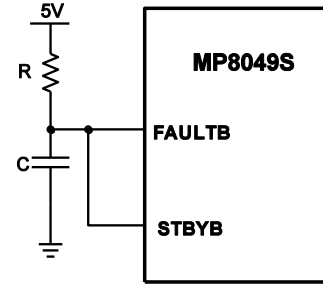

Figure 1—Fault Protection Enhancement Circuit

Fault Output

The MP8049S includes an open drain, active low fault indicator output (FAULTB). A fault will be indicated if one of the following conditions is detected: the current limit is tripped, or the thermal shutdown is tripped.

A fault on any channel will cause the FAULTB pin to be pulled low. When the fault goes away, the MP8049S will resume normal operation.

Do not apply more than 6V to the FAULTB pin.

Error Reporting

The MP8049S also have two fault monitor pins (FLT3B and FLT2B), which are active low and open-drain outputs. Their function is for protection-mode signaling to a PWM controller or other system control device, as shown in the below table.

OCP	OTP	UVP	FLT2B	FLT3B
0	0	0	1	1
0	0	1	0	1
0	1	0	1	0
1	0	0	0	0

Table 1- Fault Boolean

BLOCK DIAGRAM

Figure 2—Function Block Diagram (1 full bridge channel only)

PACKAGE INFORMATION
QFN 40 (5x5mm)

TOP VIEW

BOTTOM VIEW

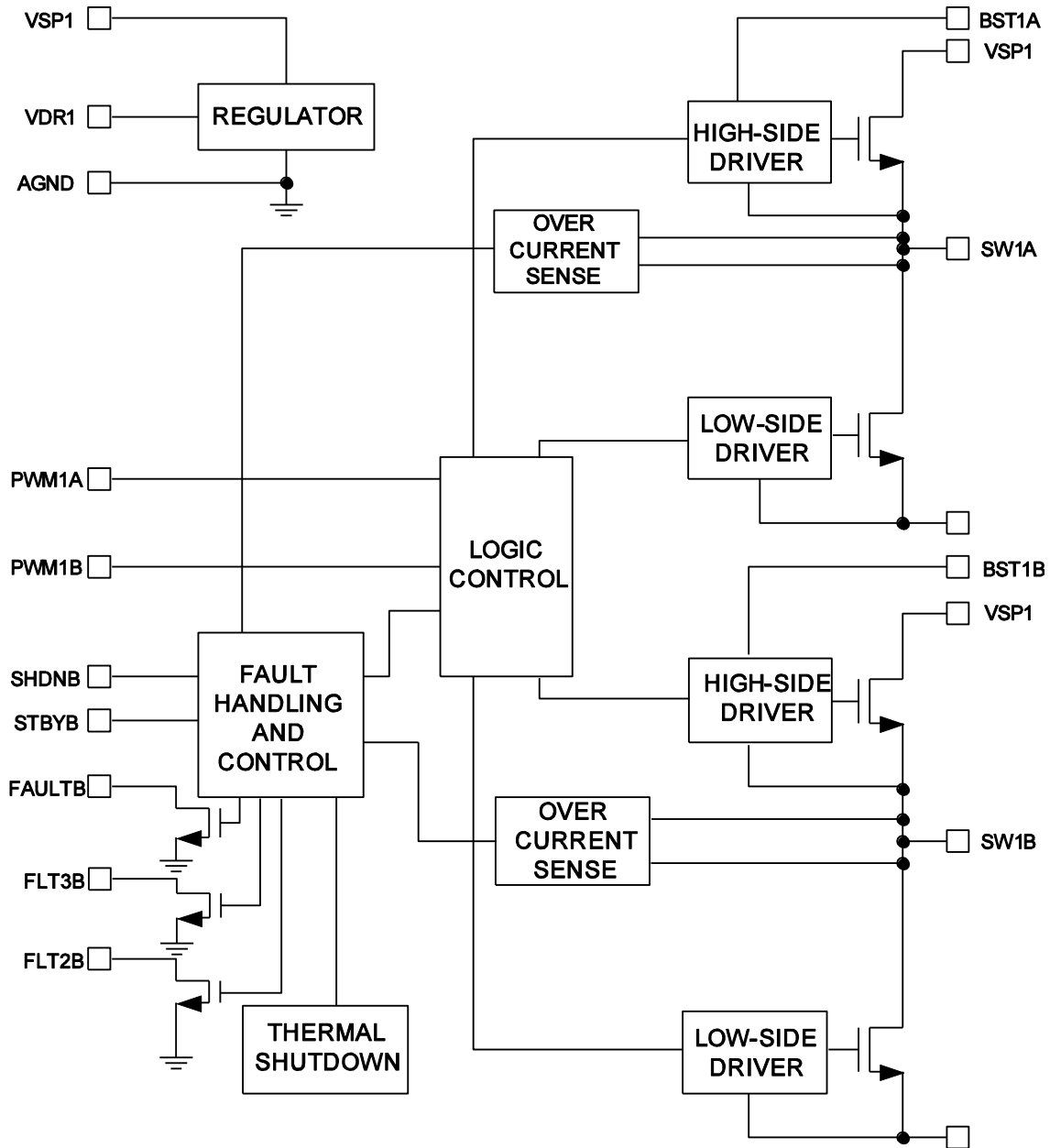
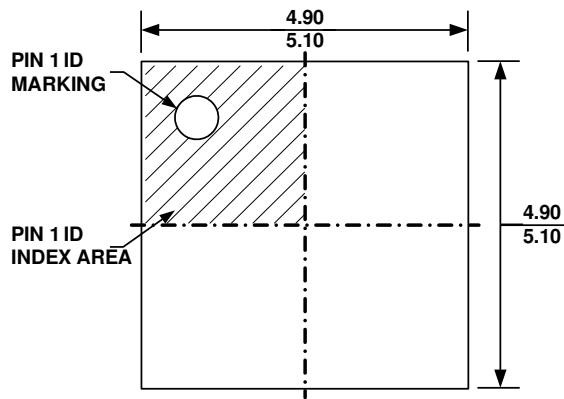
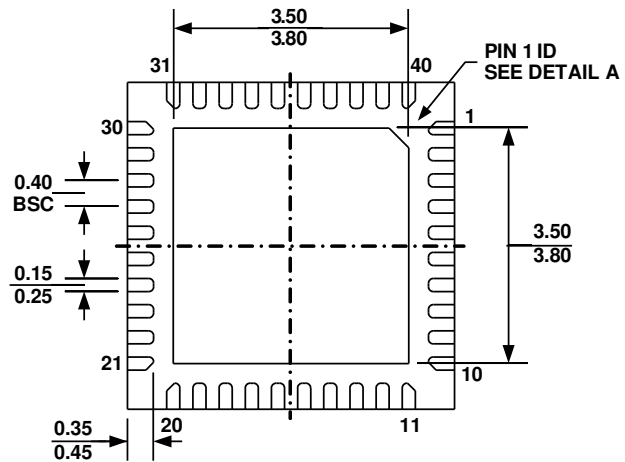
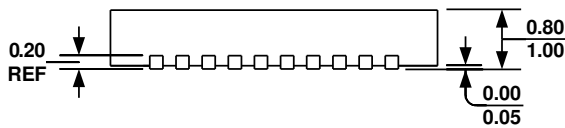
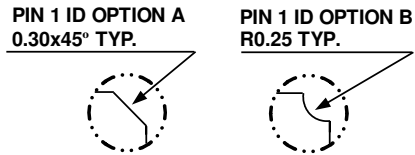
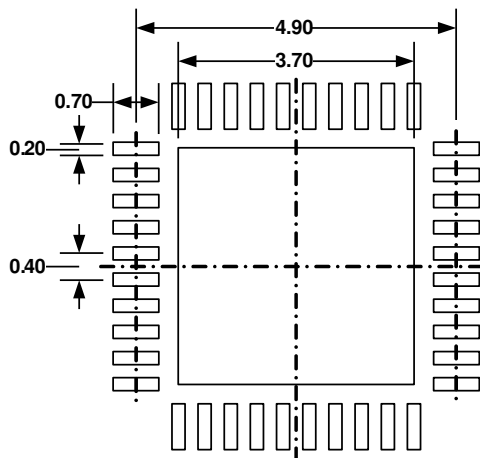
SIDE VIEW

DETAIL A

RECOMMENDED LAND PATTERN
NOTE:

- 1) ALL DIMENSIONS ARE IN MILLIMETERS
- 2) EXPOSED PADDLE SIZE DOES NOT INCLUDE MOLD FLASH
- 3) LEAD COPLANARITY SHALL BE 0.10 MILLIMETER MAX
- 4) DRAWING CONFIRMS TO JEDEC MO220, VARIATION VHHE-1.
- 5) DRAWING IS NOT TO SCALE

NOTICE: The information in this document is subject to change without notice. Users should warrant and guarantee that third party Intellectual Property rights are not infringed upon when integrating MPS products into any application. MPS will not assume any legal responsibility for any said applications.