

Chipsmall Limited consists of a professional team with an average of over 10 year of expertise in the distribution of electronic components. Based in Hongkong, we have already established firm and mutual-benefit business relationships with customers from,Europe,America and south Asia,supplying obsolete and hard-to-find components to meet their specific needs.

With the principle of “Quality Parts,Customers Priority,Honest Operation,and Considerate Service”,our business mainly focus on the distribution of electronic components. Line cards we deal with include Microchip,ALPS,ROHM,Xilinx,Pulse,ON,Everlight and Freescale. Main products comprise IC,Modules,Potentiometer,IC Socket,Relay,Connector.Our parts cover such applications as commercial,industrial, and automotives areas.

We are looking forward to setting up business relationship with you and hope to provide you with the best service and solution. Let us make a better world for our industry!



Contact us

Tel: +86-755-8981 8866 Fax: +86-755-8427 6832

Email & Skype: info@chipsmall.com Web: www.chipsmall.com

Address: A1208, Overseas Decoration Building, #122 Zhenhua RD., Futian, Shenzhen, China

Type 12 Mild Steel Miniature Pushbutton Enclosures

MPB Series



Application

- Designed to accept 22mm miniature oil tight pushbuttons, switches and pilot lights.
- Provides protection from dirt, dust, oil and water.

Standards

- UL 508 Type 12 and 13
- CSA Type 12 and 13
- **Complies with**
 - NEMA Type 12 and 13
 - JIC EMP-1-1967
 - JIC EGP-1-1967
 - IEC 60529, IP54
- Appropriate components are required to maintain these standards.

Construction

- Formed 14 gauge steel except the MPB1 which is 16 gauge.
- Smooth continuously welded seams.
- Welded brackets provide for enclosure mounting.
- Captive cover screws thread into sealed wells.
- Larger enclosures provide internally hinged removable covers, designed to hold the cover open during wiring (see table).
- Oil resistant gasket and adhesive.
- A bonding stud is provided on the door and a grounding stud is provided on the enclosure.

Finish

- Cover and enclosure are phosphatized and finished in ANSI 61 gray powder coating.

Accessories

- Hole Plugs
- Ground Wire Kits
- Pedestal and Base

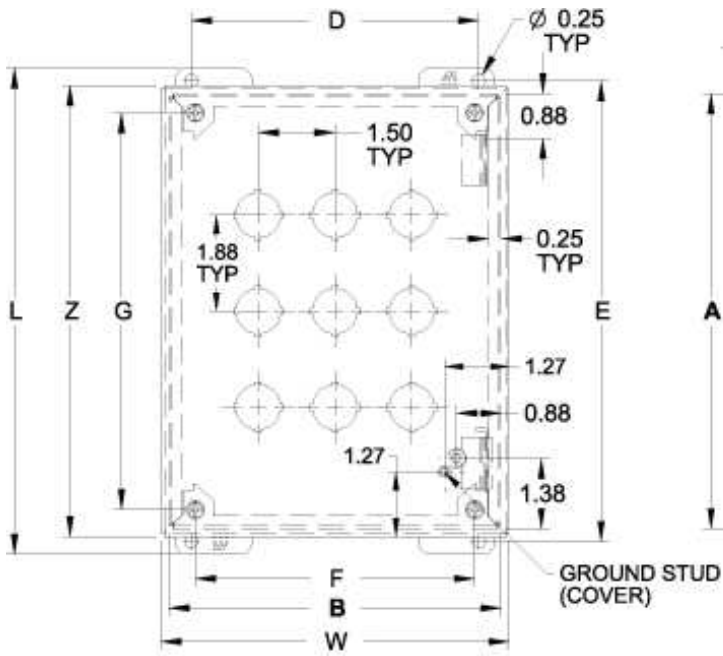

Front View
Body Type MPB6 through MPB12
(Hinged)

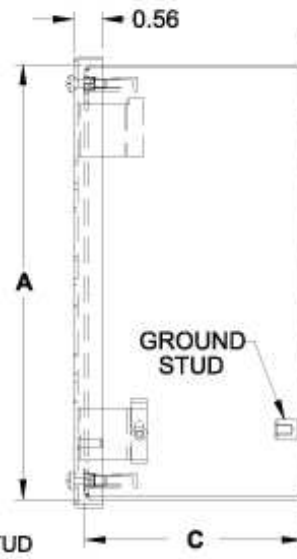

Side View

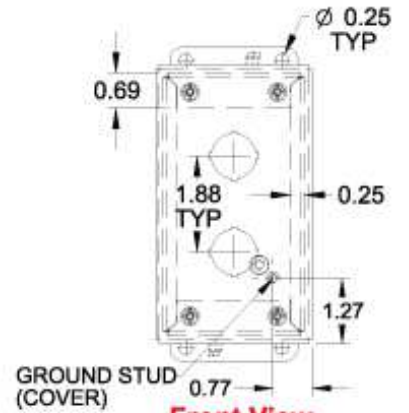

Front View
Body Type MPB1 through MPB4
(Not Hinged)

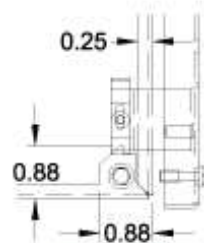

Hinge Detail
Retractable pin allows door to be
mounted on left or right side

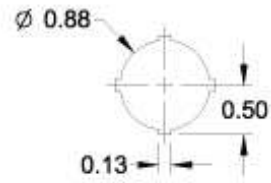

22.5mm Detail

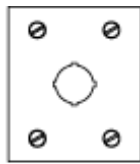

MPB1

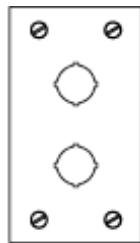

MPB2

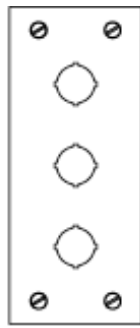

MPB3

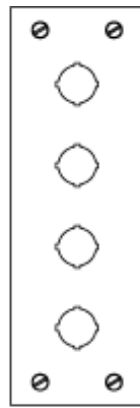

MPB4

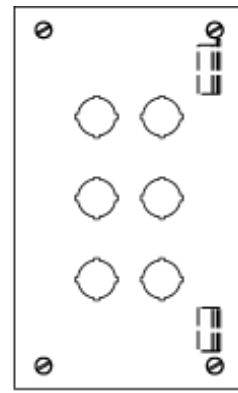

MPB6

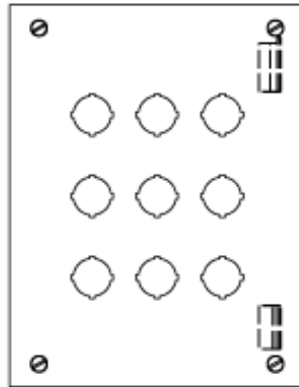

MPB9

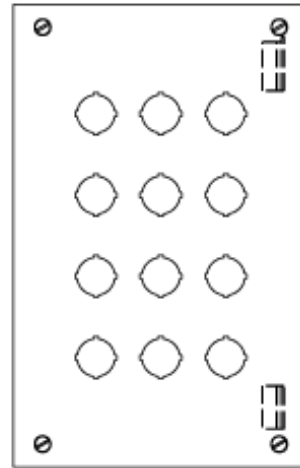

MPB12

Part No.	No. of Holes	A	B	C	D	E	F	G	Overall Dimensions			Ship Wt. (lbs)
									L	W	Z	
MPB1 ¹	1	3.25	2.75	3.50	1.88	3.75	1.71	2.50	4.25	3.06	3.56	2
MPB2 ¹	2	5.13	2.75	3.50	1.88	5.63	1.71	4.38	6.13	3.06	5.44	3
MPB3 ¹	3	7.00	2.75	3.50	1.88	7.50	1.71	6.25	8.00	3.06	7.31	3
MPB4 ¹	4	8.88	2.75	3.50	1.88	9.38	1.71	8.13	9.88	3.06	9.19	4
MPB6	6	8.50	5.00	4.25	4.13	9.00	3.96	7.75	9.50	5.31	8.81	5
MPB9	9	8.50	6.50	4.25	5.63	9.00	5.46	7.75	9.50	6.81	8.81	6
MPB12	12	10.38	6.50	4.25	5.63	10.88	5.46	9.63	11.38	6.81	10.69	6

¹ Not hinged

Data subject to change without notice