



Chipsmall Limited consists of a professional team with an average of over 10 year of expertise in the distribution of electronic components. Based in Hongkong, we have already established firm and mutual-benefit business relationships with customers from,Europe,America and south Asia,supplying obsolete and hard-to-find components to meet their specific needs.

With the principle of "Quality Parts,Customers Priority,Honest Operation,and Considerate Service",our business mainly focus on the distribution of electronic components. Line cards we deal with include Microchip,ALPS,ROHM,Xilinx,Pulse,ON,Everlight and Freescale. Main products comprise IC,Modules,Potentiometer,IC Socket,Relay,Connector.Our parts cover such applications as commercial,industrial, and automotives areas.

We are looking forward to setting up business relationship with you and hope to provide you with the best service and solution. Let us make a better world for our industry!



Contact us

Tel: +86-755-8981 8866 Fax: +86-755-8427 6832

Email & Skype: info@chipsmall.com Web: www.chipsmall.com

Address: A1208, Overseas Decoration Building, #122 Zhenhua RD., Futian, Shenzhen, China



DESCRIPTION

The MPQ2451-5/33 is a high-frequency, step-down, switching regulator with an integrated, high-voltage, high-side power MOSFET. It efficiently outputs up to 0.6A, with current-mode control for fast loop response.

The wide 3.3V-to-36V input range accommodates a variety of automotive step-down applications, and the 3µA shutdown-mode quiescent current allows use in battery-powered applications.

The MPQ2451-5/33 achieves high power-conversion efficiency over a wide load range by scaling down the switching frequency under light-load conditions to reduce switching and gate driving losses.

Frequency fold-back prevents inductor current runaway during start-up. Thermal shutdown provides reliable, fault-tolerant operation.

The MPQ2451-5/33 is available in cost-effective SOT23-6L and QFN-6L packages.

FEATURES

- Guaranteed Industrial/Automotive Temp. Ranges
- 130µA Operating Quiescent Current
- Wide 3.3V-to-36V Operating Input Range
- 500mΩ Internal Power MOSFET
- 2.2MHz Fixed Switching Frequency
- Internally Compensated
- Stable with Ceramic Output Capacitors
- Internal Soft-Start
- Precision Current Limit Without Current Sensing Resistor
- >90% Efficiency
- Fixed 5V & 3.3V Outputs
- 6-Lead SOT23 and QFN Packages
- Available in AEC-Q100 Grade 1

APPLICATIONS

- High-Voltage Power Conversion, Including
 - Automotive Systems
 - Industrial Power Systems
 - Distributed Power Systems
 - Battery-Powered Systems

All MPS parts are lead-free and adhere to the RoHS directive. For MPS green status, please visit MPS website under Products, Quality Assurance page. "MPS" and "The Future of Analog IC Technology" are registered trademarks of Monolithic Power Systems, Inc.

TYPICAL APPLICATION

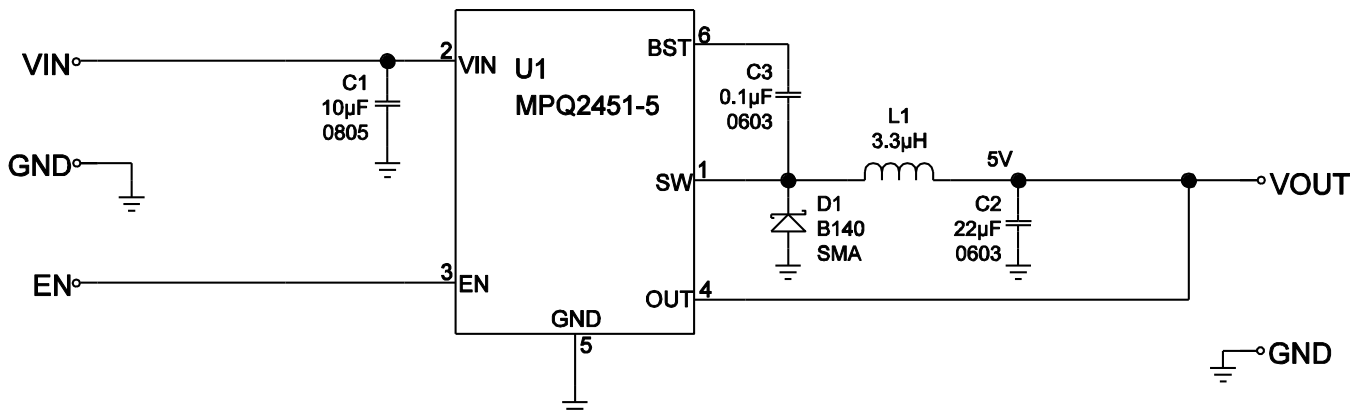

ORDERING INFORMATION

Part Number	Package	Top Marking
MPQ2451GT-5*	SOT23-6L	AGE
MPQ2451GT-5-AEC1		
MPQ2451GT-33**		AGF
MPQ2451GT-33-AEC1		
MPQ2451GG-5	QFN-6L	BP
MPQ2451GG-5-AEC1		
MPQ2451GG-33		BQ
MPQ2451GG-33-AEC1		

* For Tape & Reel, add suffix -Z (e.g. MPQ2451GT-5-AEC1-Z)

** For Tape & Reel, add suffix -Z (e.g. MPQ2451GT-33-Z)

PACKAGE REFERENCE

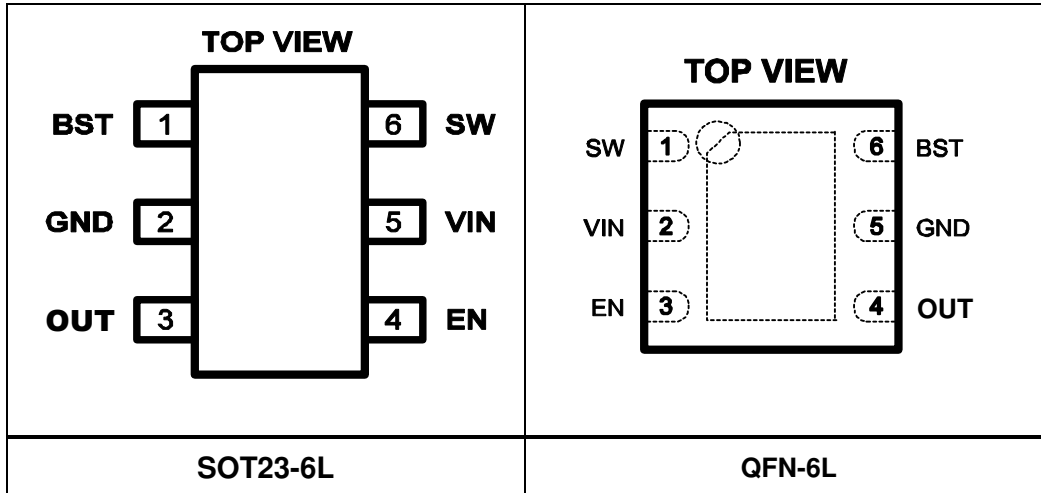

ABSOLUTE MAXIMUM RATINGS ⁽¹⁾

Supply Voltage (V_{IN}).....	-0.3V to +40V
Switch Voltage (V_{SW}).....	-0.3V to ($V_{IN}+0.3V$)
BST to SW.....	-0.3 to +5.0V
All Other Pins.....	-0.3V to +5.0V
Continuous Power Dissipation ($T_A = 25^\circ\text{C}$) ⁽²⁾	
SOT23-6L.....	0.57W
QFN-6L.....	1.56W
Junction Temperature.....	150°C
Lead Temperature.....	260°C
Storage Temperature.....	-65°C to +150°C

Recommended Operating Conditions ⁽³⁾

Supply Voltage V_{IN}	3.3V to 36V
Operating Junction Temp. (T_J).....	-40°C to +125°C

Thermal Resistance ⁽⁴⁾ θ_{JA} θ_{JC}

SOT23-6L.....	220	110	°C/W
QFN-6L.....	80	16	°C/W

Notes:

- Exceeding these ratings may damage the device.
- The maximum allowable power dissipation is a function of the maximum junction temperature T_J (MAX), the junction-to-ambient thermal resistance θ_{JA} , and the ambient temperature T_A . The maximum allowable continuous power dissipation at any ambient temperature is calculated by P_D (MAX) = $(T_J$ (MAX)- T_A)/ θ_{JA} . Exceeding the maximum allowable power dissipation will cause excessive die temperature, and the regulator will go into thermal shutdown. Internal thermal shutdown circuitry protects the device from permanent damage.
- The device is not guaranteed to function outside of its operating conditions.
- Measured on JESD51-7, 4-layer PCB.

ELECTRICAL CHARACTERISTICS

$V_{IN} = 12V$, $V_{EN} = 2V$, $T_J = -40^{\circ}C$ to $+125^{\circ}C$, unless otherwise noted. Typical values are at $T_J = 25^{\circ}C$.

Parameter	Symbol	Condition	Min	Typ	Max	Units
Output Voltage	MPQ2451-5	$6V < V_{IN} < 36V$	4.8	5	5.2	V
		$6V < V_{IN} < 36V$, $T_J = 25^{\circ}C$	4.85	5	5.15	
	MPQ2451-33	$3.3V < V_{IN} < 36V$	3.168	3.3	3.432	V
		$3.3V < V_{IN} < 36V$, $T_J = 25^{\circ}C$	3.2	3.3	3.4	
Upper Switch-On Resistance	$R_{DS(ON)}$	$V_{BST} - V_{SW} = 5V$ $T_J = 25^{\circ}C$		500		m Ω
Upper Switch Leakage		$V_{EN} = 0V$, $V_{SW} = 0V$		0.5	2	μA
Current Limit	I_{LIM}	$T_J = 25^{\circ}C$	0.75	1		A
		$T_J = -40^{\circ}C$ to $+125^{\circ}C$	0.65			
COMP to Current Sense Transconductance ⁽⁵⁾	G_{CS}			3		A/V
V_{IN} UVLO, Upper Threshold			2.7		3.29	V
V_{IN} UVLO, Hysteresis				0.4		V
Soft-Start Time				0.5	1	ms
Oscillator Frequency	f_{SW}		1.8	2.2	2.6	MHz
Minimum Switch-On Time ⁽⁵⁾	τ_{ON}			80		ns
Shutdown Supply Current	I_S	$V_{EN} < 0.3V$			1	μA
Quiescent Supply Current	I_Q	No load, no switching		130	170	μA
Thermal Shutdown ⁽⁵⁾				150		$^{\circ}C$
Enable Threshold, High	V_{IH}	Low-to-High	1.35	1.5	1.8	V
Enable Threshold, Hysteresis				400		mV

Notes:

5) Derived from bench characterization, not tested in production.

PIN FUNCTIONS

SOT23-6L Pin #	QFN-6L Pin #	Name	Description
1	6	BST	Bootstrap. Positive power supply for the internal, floating, high-side MOSFET driver. Connect a bypass capacitor between this pin and SW pin.
2	5	GND	Ground. Connect the output capacitor as close to this pin as possible. Avoid routing near high-current switch paths.
3	4	OUT	Output-Voltage Sense. Connected to the tap of an internal resistor divider to set the output voltage.
4	3	EN	Enable. Pull this pin below the specified threshold to shut the chip down. Pull it above the specified threshold to enable the chip. Float this pin to disable the chip.
5	2	VIN	Input Supply. Supplies power to all internal control circuitry. Requires a decoupling capacitor to ground to reduce switching spikes.
6	1	SW	Switch Node. Output of the high-side switch. Requires a low- V_F Schottky diode connected to ground to reduce switching spikes.

TYPICAL CHARACTERISTICS

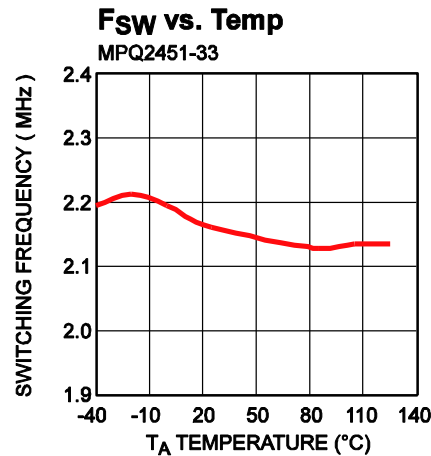
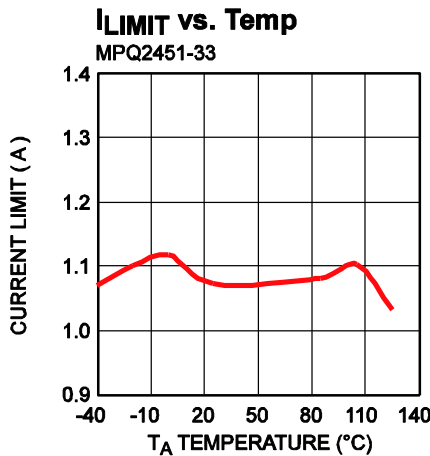
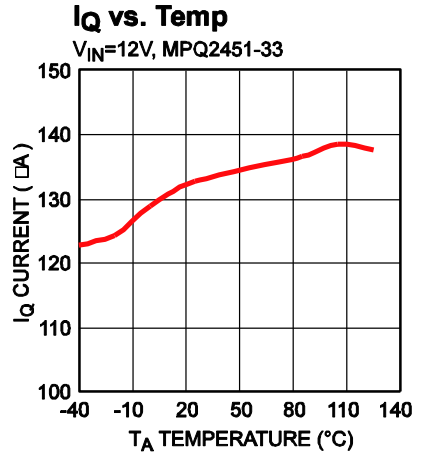
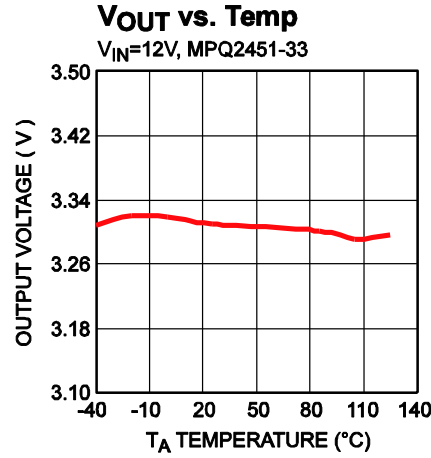
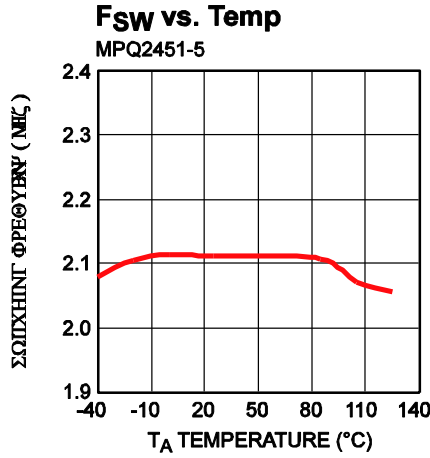
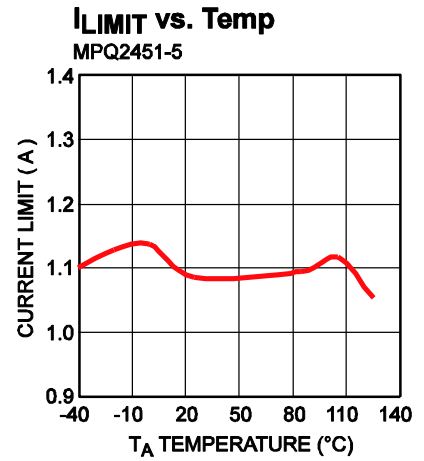
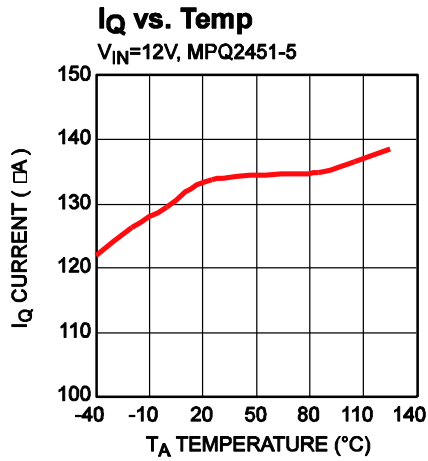
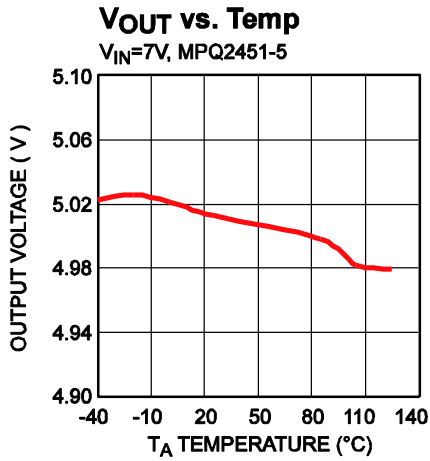

TYPICAL PERFORMANCE CHARACTERISTICS

$V_{IN} = 12V$, $C1 = 10\mu F$, $C2 = 22\mu F$, $L = 3.3\mu H$ and $T_A = 25^\circ C$, unless otherwise noted.

MPQ2451-5

Load Efficiency

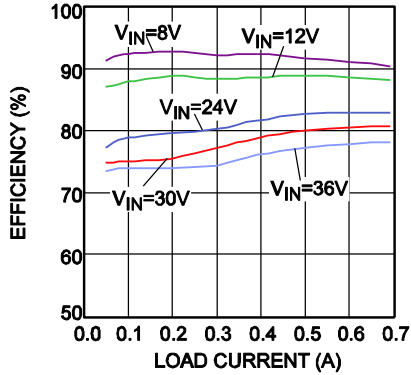

Line Efficiency

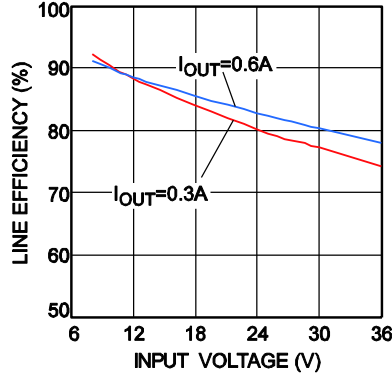

Load Regulation

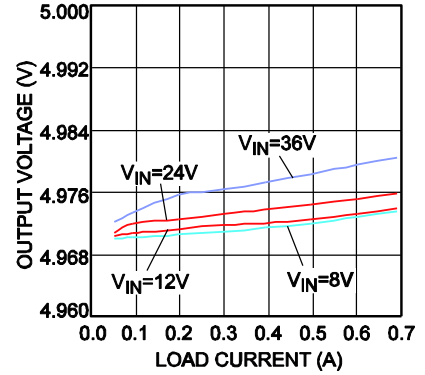

Line Regulation

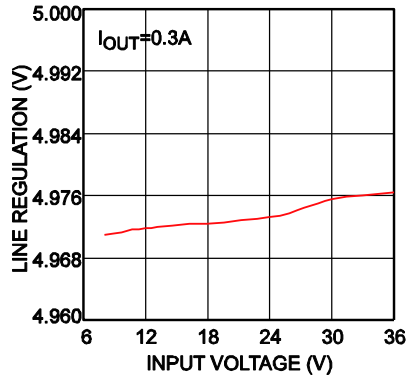

Load Transient

$V_{IN} = 8V$, $I_{OUT} = 50mA-0.6A$

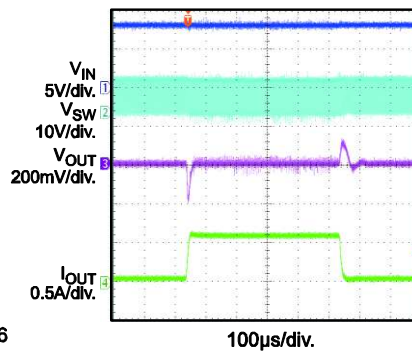

Load Transient

$V_{IN} = 12V$, $I_{OUT} = 50mA-0.6A$

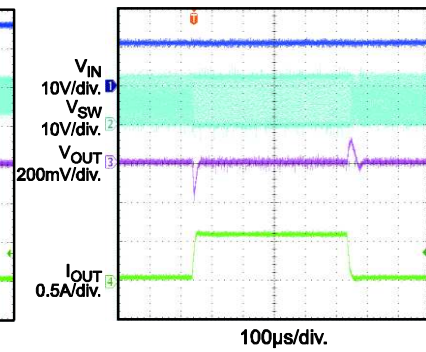

Power Ramp Up

$V_{IN} = 12V$, $I_{OUT} = 0.5A$

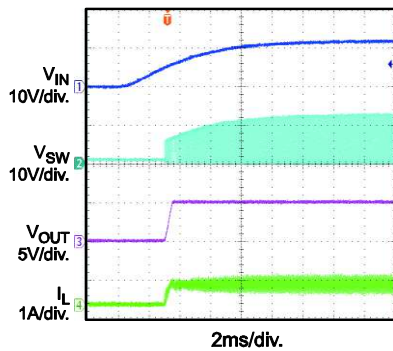

Power Ramp Down

$V_{IN} = 12V$, $I_{OUT} = 0.5A$

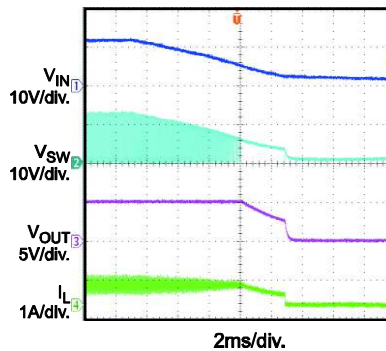

Steady State

$V_{IN} = 7.5V$, $I_{OUT} = 0.6A$

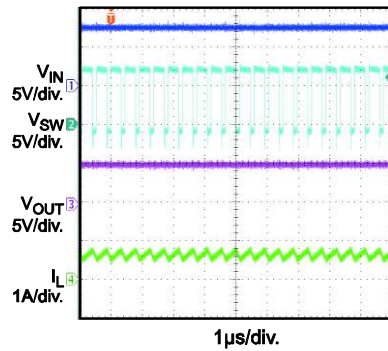

TYPICAL PERFORMANCE CHARACTERISTICS *(continued)*

$V_{IN} = 12V$, $C1 = 10\mu F$, $C2 = 22\mu F$, $L = 3.3\mu H$ and $T_A = 25^\circ C$, unless otherwise noted.

MPQ2451-5

Steady State

$V_{IN} = 36V$, $I_{OUT} = 0.6A$

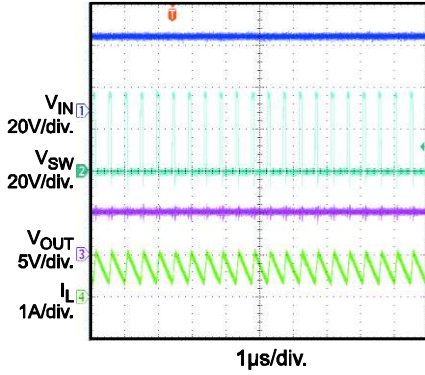

Enable On

$V_{IN} = 12V$, $I_{OUT} = 0.5A$

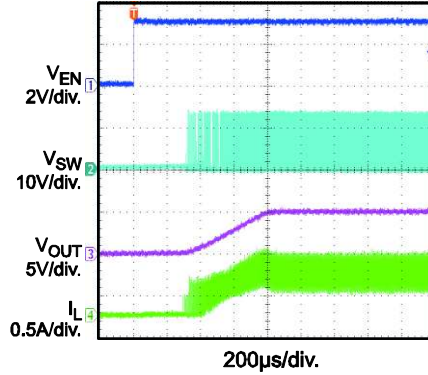

Enable Off

$V_{IN} = 12V$, $I_{OUT} = 0.5A$

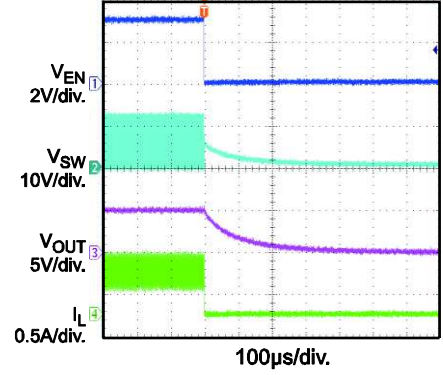

Short Output

$V_{IN} = 12V$, $I_{OUT} = 0.5A$

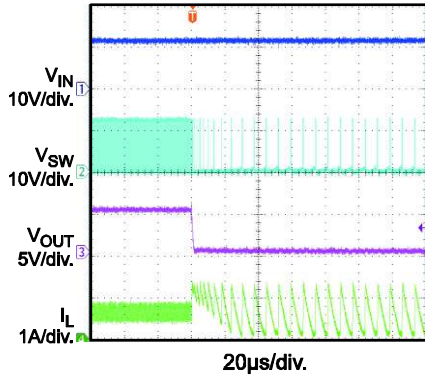

Short Output Recovery

$V_{IN} = 12V$, $I_{OUT} = 0.5A$

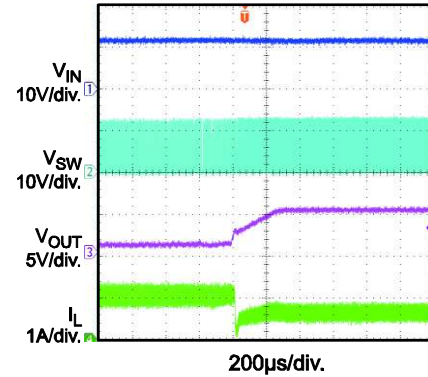

Short Output Start Up

$V_{IN} = 8V$, $I_{OUT} = 0.5A$

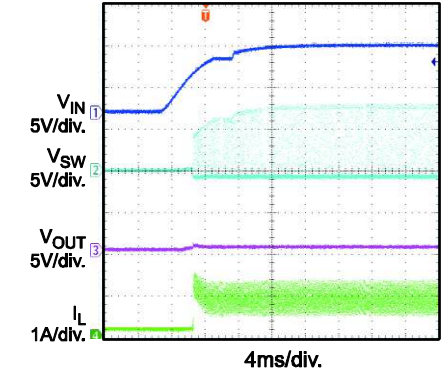

TYPICAL PERFORMANCE CHARACTERISTICS *(continued)*

$V_{IN} = 12V$, $C1 = 10\mu F$, $C2 = 22\mu F$, $L = 3.3\mu H$ and $T_A = 25^\circ C$, unless otherwise noted.

MPQ2451-33

Load Efficiency

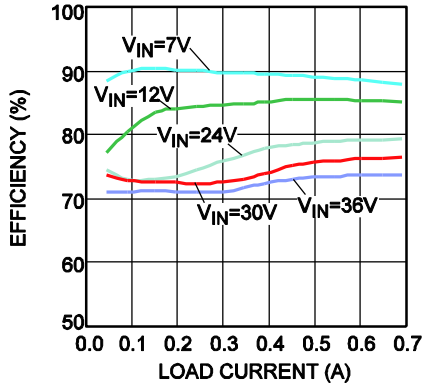

Line Efficiency

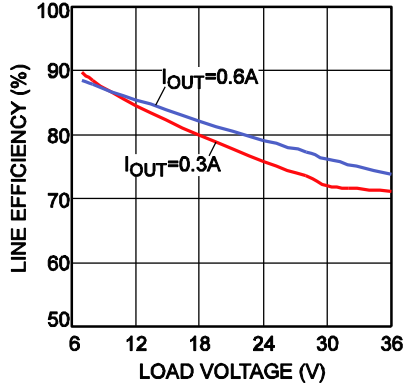

Load Regulation

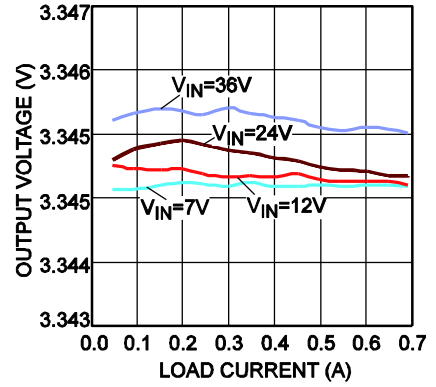

Line Regulation

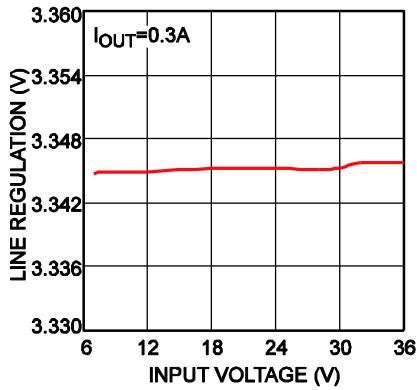

Load Transient

$V_{IN} = 7V$, $I_{OUT} = 50mA-0.6A$

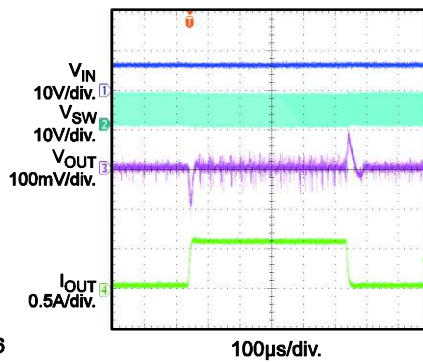

Load Transient

$V_{IN} = 12V$, $I_{OUT} = 50mA-0.6A$

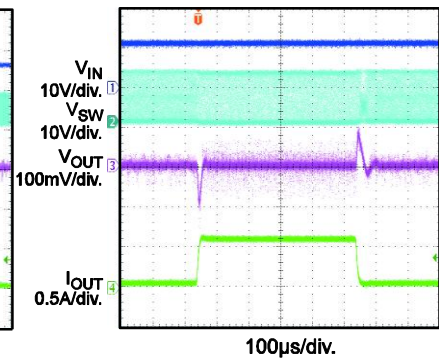

Power Ramp Up

$V_{IN} = 12V$, $I_{OUT} = 0.5A$

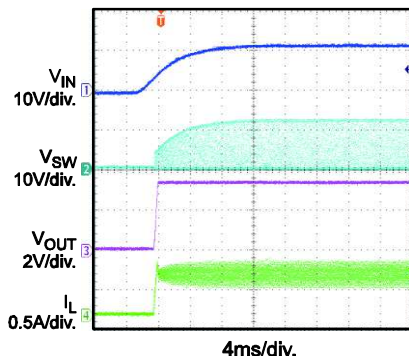

Power Ramp Down

$V_{IN} = 12V$, $I_{OUT} = 0.5A$

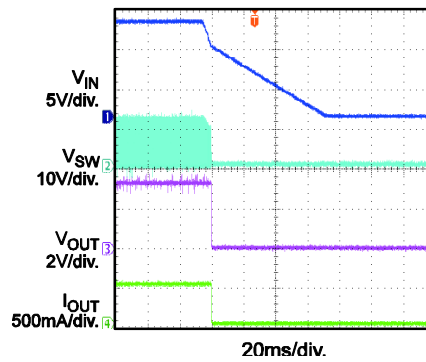

Steady State

$V_{IN} = 5.7V$, $I_{OUT} = 0.6A$

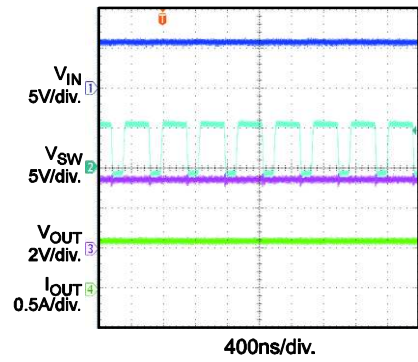

TYPICAL PERFORMANCE CHARACTERISTICS (continued)

$V_{IN} = 12V$, $C1 = 10\mu F$, $C2 = 22\mu F$, $L = 3.3\mu H$ and $T_A = 25^\circ C$, unless otherwise noted.

MPQ2451-33

Steady State

$V_{IN} = 32V$, $I_{OUT} = 0.6A$

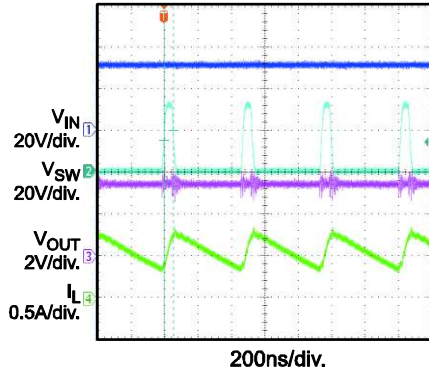

Enable On

$V_{IN} = 12V$, $I_{OUT} = 0.5A$

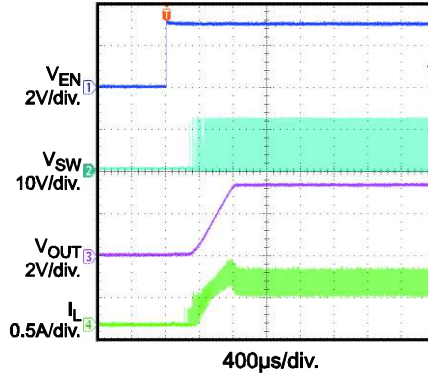

Enable Off

$V_{IN} = 12V$, $I_{OUT} = 0.5A$

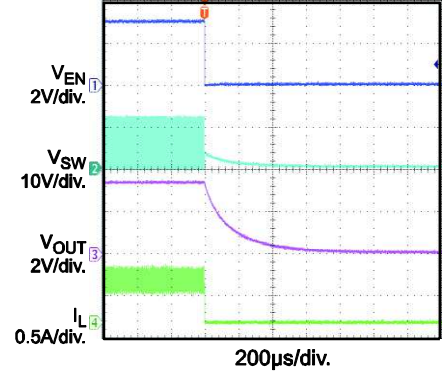

Short Output

$V_{IN} = 12V$, $I_{OUT} = 0.5A$

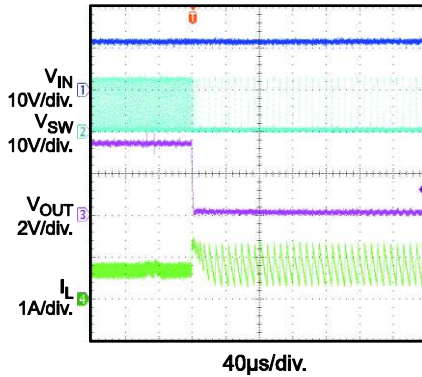

Short Output Recovery

$V_{IN} = 12V$, $I_{OUT} = 0.5A$

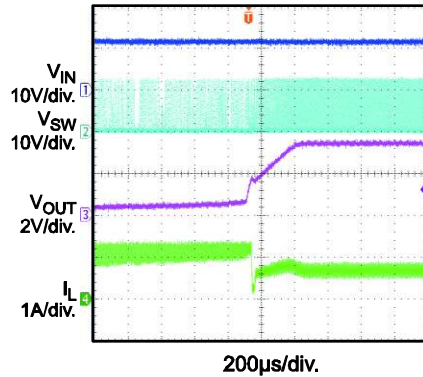

Short Output Start Up

$V_{IN} = 7V$, $I_{OUT} = 0.5A$

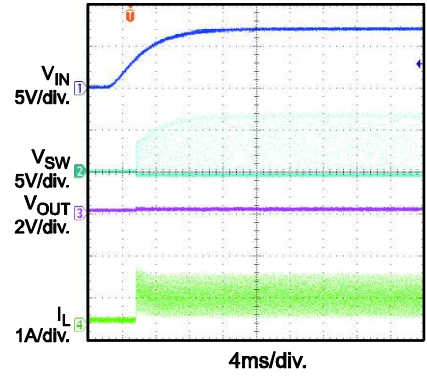

FUNCTIONAL BLOCK DIAGRAM

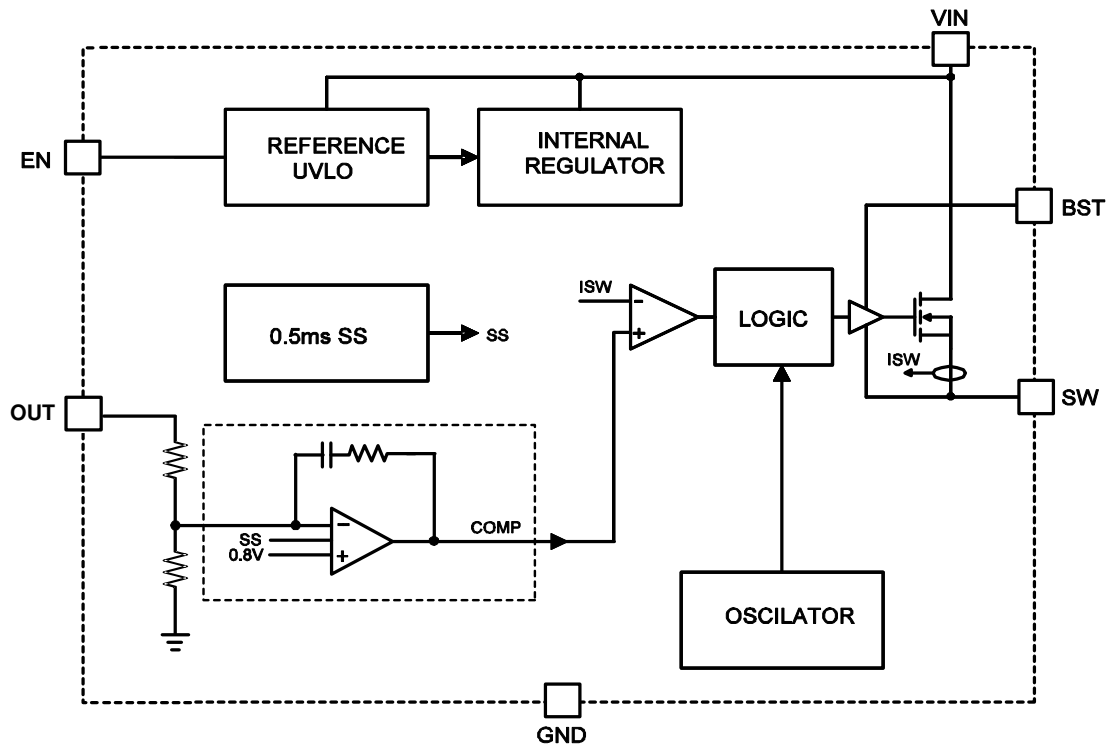

Figure 1: Functional Block Diagram

OPERATION

The MPQ2451-5/33 is a 2.2MHz, asynchronous, step-down, switching regulator with an integrated high-side, high-voltage, power MOSFET. It provides an internally-compensated, highly-efficient output of up to 0.6A with current-mode control. It also features a wide input voltage range, internal soft-start control, and a precise current limit. Its very-low, operational, quiescent current makes it suitable for battery-powered applications.

PWM Control

At moderate-to-high output current, the MPQ2451-5/33 operates in a fixed-frequency, peak-current-control mode to regulate the output voltage. A PWM cycle—initiated by the internal clock—turns the power MOSFET on, and the MOSFET remains on until its current reaches the value set by V_{COMP} . When the PWM signal goes low, the power switch turns off and remains off for at least 100ns before the next cycle starts.

If the current in the power MOSFET does not reach the COMP-set current value within one PWM cycle, the power MOSFET remains ON to avoid a turn-off operation.

Pulse-Skipping Mode

Under light-load conditions, the MPQ2451-5/33 enters pulse-skipping mode to improve efficiency. Pulse-skipping occurs when V_{COMP} drops below the internal sleep threshold, which generates a PAUSE command to block the turn-on clock pulse so the power MOSFET does not turn ON; this procedure reduces gate driving and switching losses. This PAUSE command causes the whole chip to enter sleep mode, reducing the quiescent current to further improve light-load efficiency.

When V_{COMP} exceeds the sleep threshold, the PAUSE signal resets and the chip resumes normal PWM operation. Whenever the PAUSE changes state from LOW to HIGH, the PWM signal immediately goes HIGH and turns on the power MOSFET.

Error Amplifier

The error amplifier is composed of an internal op-amp with an RC feedback network connected between its output node (COMP) and its negative input node (FB). When V_{FB} drops below the internal reference voltage (V_{REF}), the op-amp

drives the COMP output high, driving the switch peak current to rise and deliver more energy to the output. Conversely, when V_{FB} rises above V_{REF} , the switch peak current output drops.

Internal Regulator

The 2.6V internal regulator powers most of the internal circuitry. This regulator takes the V_{IN} input and operates in the full V_{IN} range. When V_{IN} exceeds 3.0V, the output of the regulator is in full regulation. When V_{IN} drops below 3.0V, the output degrades.

Enable Control

The MPQ2451-5/33 has a dedicated enable control pin, EN. When V_{IN} rises above threshold, the EN pin can enable or disable the chip for HIGH effective logic. Its falling threshold is 1.2V, and its rising threshold is about 1.6V. When left floating, the EN pin is internally pulled down to GND to disable the chip.

When the EN voltage is pulled to 0V, the chip enters the lowest shutdown current mode. Between 0V and the rising threshold, the chip remains in shutdown mode with a slightly higher shutdown current.

Under-Voltage Lockout (UVLO)

V_{IN} under-voltage lockout (UVLO) protects the chip from operating at an insufficient supply voltage. The UVLO rising threshold is ~2.9V while its falling threshold is 2.6V.

Internal Soft-Start

A reference-type soft-start (SS) prevents the converter-output voltage from overshooting during startup. When the chip starts, the internal circuitry generates a soft-start voltage (V_{SS}) that ramps up from 0V over the SS time. When V_{SS} is less than V_{REF} , V_{SS} overrides V_{REF} as the error amplifier reference.

The maximum V_{SS} is approximately the same as V_{FB} ; i.e. if V_{FB} falls, the maximum of V_{SS} falls. This accommodates short-circuit recovery; when the short-circuit is removed, V_{SS} ramps up to prevent output-voltage overshoot.

Thermal Shutdown

Thermal shutdown prevents thermal runaway. When the silicon die temperature exceeds its upper threshold, the entire chip shuts down. When the temperature drops below its lower threshold, the chip is enabled again.

Floating Driver and Bootstrap Charging

An external bootstrap capacitor powers the floating-power-MOSFET driver. This floating driver has its own UVLO protection with a rising threshold of about 2.4V and a falling threshold of about 300mV. During this UVLO, V_{SS} resets to 0V. When the UVLO is removed, the controller enters soft-start.

The dedicated internal-bootstrap regulator charges and regulates the bootstrap capacitor to about 5V. When the voltage between the BST and SW nodes falls below its regulation, a PMOS pass transistor connected from V_{IN} to BST turns on. The charging current path goes from $V_{IN} \rightarrow$ BST \rightarrow SW. The external circuit must provide enough voltage headroom to facilitate charging.

If V_{IN} is sufficiently higher than V_{SW} , the bootstrap capacitor will charge. When the power MOSFET is ON, $V_{IN}=V_{SW}$ so the bootstrap capacitor does not charge. Optimal charging occurs when $V_{IN}-V_{SW}$ reaches its apex when the external freewheeling diode is on. When there is no current in the inductor, $V_{SW}=V_{OUT}$ so $V_{IN}-V_{OUT}$ can charge the bootstrap capacitor.

At a higher duty cycle, the bootstrap capacitor may not be charged sufficiently because of a shorter charging period. If there is insufficient voltage and time to charge the bootstrap capacitor, add an extra external circuit to ensure the bootstrap voltage in normal operation region.

The floating driver's UVLO is not communicated to the controller.

Make sure the bleed-through current at the SW node is at least higher than the floating driver's DC quiescent current of about 20 μ A.

Current Comparator and Current Limit

A current-sense MOSFET senses the power MOSFET current. This value is the input to the high-speed-current comparator for current-mode control. When the power MOSFET turns on, the comparator is first blanked to limit noise, and then compares the power switch current to the

V_{COMP} . When the sensed value exceeds V_{COMP} , the comparator output goes LOW to turn off the power MOSFET. The maximum current of the internal power MOSFET is internally limited cycle-by-cycle.

Startup and Shutdown

If both V_{IN} and V_{EN} exceed their respective thresholds, the chip starts. The reference block starts first to generate a stable reference voltage and current, and then the internal regulator operates to provide a stable supply for the rest circuit.

While the internal supply rail is up, an internal timer turns the power MOSFET off for about 50 μ s to blank startup noise. When the internal soft-start block is enabled, it first holds its SS output low to ensure the rest of the circuit is ready before ramping up.

Three events shut down the chip: EN low, V_{IN} low, thermal shutdown. During shutdown, the signaling path is blocked first to avoid any fault triggering. V_{COMP} and the internal supply rail are then pulled low. The floating driver is not subject to this shutdown command but its charging path is disabled.

APPLICATION INFORMATION

COMPONENT SELECTION

Inductor

The inductor supplies constant current to the output load while being driven by the switched input voltage. A larger-value inductor will result in less ripple current and lower output ripple voltage. However, the larger-value inductor is typically physically larger, has a higher series resistance, or has a lower saturation current.

To determine the inductance, allow the peak-to-peak ripple current in the inductor to be approximately 30% of the maximum load current. Also, chose a peak inductor current below the maximum switch current limit. The inductance value can be calculated by:

$$L1 = \frac{V_{OUT}}{f_S \times \Delta I_L} \times \left(1 - \frac{V_{OUT}}{V_{IN}} \right)$$

Where V_{OUT} is the output voltage, V_{IN} is the input voltage, f_S is the switching frequency, and ΔI_L is the peak-to-peak inductor ripple current.

Choose an inductor that will not saturate under the maximum inductor peak current. The peak inductor current can be calculated by:

$$I_{LP} = I_{LOAD} + \frac{V_{OUT}}{2 \times f_S \times L1} \times \left(1 - \frac{V_{OUT}}{V_{IN}} \right)$$

Where I_{LOAD} is the load current.

Table 2 lists a number of suitable inductors from various manufacturers. The choice of which style inductor to use mainly depends on the price vs. size requirements and any EMI requirement.

Table 1: Inductor Selection Guide

Part Number	Inductance (μH)	Max DCR (Ω)	Current Rating (A)	Dimensions L × W × H (mm ³)
Würth Electronics				
7440430022	2.2	0.028	2.5	4.8×4.8×2.8
744043003	3.3	0.035	2.15	4.8×4.8×2.8
7447785004	4.7	0.078	2.4	5.9×6.2×3.2
TOKO				
D63CB-#A916CY-2R0M	2.0	0.019	2.36	6.2×6.3×3.0
D62CB-#A916CY-3R3M	3.3	0.026	2.17	6.2×6.3×3.0
D62CB-#A916CY-4R7M	4.7	0.032	2.1	6.2×6.3×3.0
TDK				
LTF5022T-2R2N3R2	2.2	0.04	3.2	5.2×5.0×2.2
LTF5022T-3R3N2R5	3.3	0.06	2.5	5.2×5.0×2.2
LTF5022T-4R7N2R0	4.7	0.081	2.0	5.2×5.0×2.2
COOPER BUSSMANN				
SD25-2R2	2.2	0.031	2.8	5.2×5.2×2.5
SD25-3R3	3.3	0.038	2.21	5.2×5.2×2.5
SD25-4R7	4.7	0.047	1.83	5.2×5.2×2.5

The input capacitor (C1) can be electrolytic, tantalum or ceramic. When using electrolytic or tantalum capacitors, add a small, high quality ceramic capacitor—for example, 0.1μF—as close to the IC as possible. When using ceramic capacitors, make sure that they have enough capacitance to provide sufficient charge to prevent excessive voltage ripple at input. The input voltage ripple caused by capacitance can be estimated by:

$$\Delta V_{IN} = \frac{I_{LOAD}}{f_s \times C1} \times \frac{V_{OUT}}{V_{IN}} \times \left(1 - \frac{V_{OUT}}{V_{IN}}\right)$$

Output Capacitor

The output capacitor (C2) maintains the DC output voltage. Ceramic, tantalum, or low ESR electrolytic capacitors are recommended. Low ESR capacitors are preferred to keep the output voltage ripple low. The output voltage ripple can be estimated by:

$$\Delta V_{OUT} = \frac{V_{OUT}}{f_s \times L} \times \left(1 - \frac{V_{OUT}}{V_{IN}}\right) \times \left(R_{ESR} + \frac{1}{8 \times f_s \times C2}\right)$$

Where L is the inductor value and R_{ESR} is the equivalent series resistance (ESR) value of the output capacitor.

For ceramic capacitors, the impedance at the switching frequency is dominated by the capacitance. The output voltage ripple is mainly caused by the capacitance. For simplification, the output voltage ripple can be estimated by:

$$\Delta V_{OUT} = \frac{V_{OUT}}{8 \times f_s^2 \times L \times C2} \times \left(1 - \frac{V_{OUT}}{V_{IN}}\right)$$

For tantalum or electrolytic capacitors, the ESR dominates the impedance at the switching frequency. For simplification, the output ripple can be approximated to:

$$\Delta V_{OUT} = \frac{V_{OUT}}{f_s \times L} \times \left(1 - \frac{V_{OUT}}{V_{IN}}\right) \times R_{ESR}$$

The characteristics of the output capacitor also affect the stability of the regulation system.

External Bootstrap Diode

An external bootstrap diode from 5V to the BST pin may enhance the efficiency of the regulator if there is a 5V rail available to the system, $V_{IN} \leq 6V$, or for high-duty-cycle ($V_{OUT}/V_{IN} > 65\%$) applications.

A low-cost bootstrap diode, such as IN4148 or BAT54, is suitable for such applications.

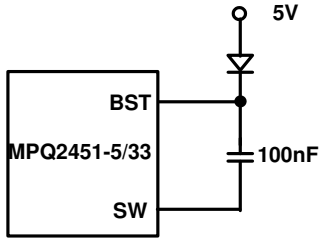

Figure 2: External Bootstrap Diode

At no load or light load, the converter may operate in pulse-skipping mode in order to regulate the output voltage and leave less time to refresh the BST voltage. To ensure sufficient gate voltage, select $(V_{IN} - V_{OUT}) > 3V$. To meet this requirement, the EN pin can be used to program the input UVLO voltage to $V_{OUT}+3V$.

PCB Layout

PCB layout requires high-frequency noise considerations to limit voltage spikes on the SW node and to limit EMI noise. Keep the path of the input decoupling capacitor, catch diode, the V_{IN} pin, SW pin, and PGND as short as possible using short and wide traces, with the passive components as close to the device as possible.

Run the feedback trace far from the inductor and noisy power traces: if possible, run the feedback trace on the opposite side of the PCB from the inductor, separated by a ground plane. Expect greater switching losses at high switching frequencies.

Add a grid of thermal vias under the exposed pad to improve thermal conductivity. Use small vias (15mil barrel diameter) so that the hole fills during the plating process, and to avoid solder wicking during the reflow process associated with larger vias. Use a pitch (distance between the centers) of approximately 40mil between the thermal vias. Please refer to the layout example on EVQ2451-G-33 datasheet.

TYPICAL APPLICATION CIRCUITS (QFN-6L)

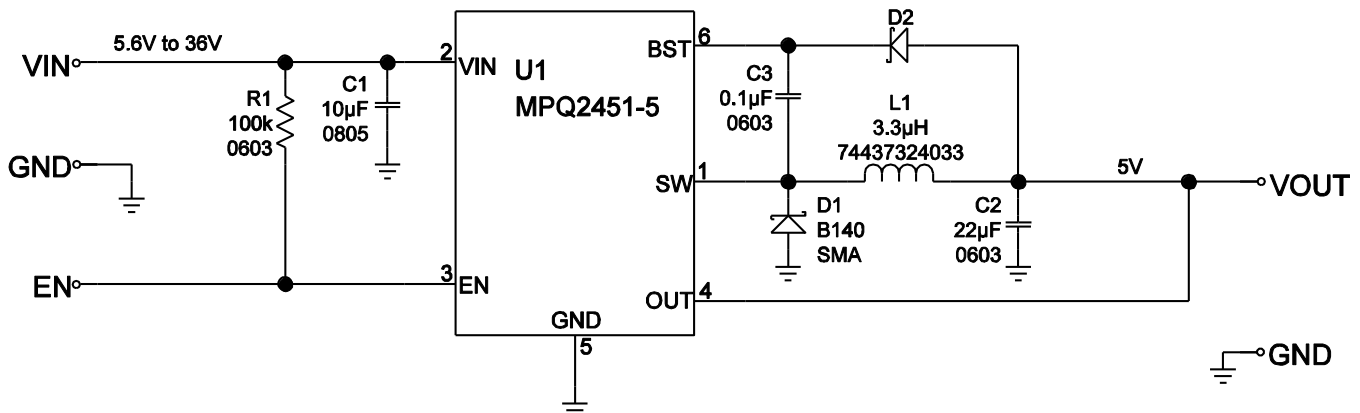

Figure 3: 5V Output Typical Application Schematic

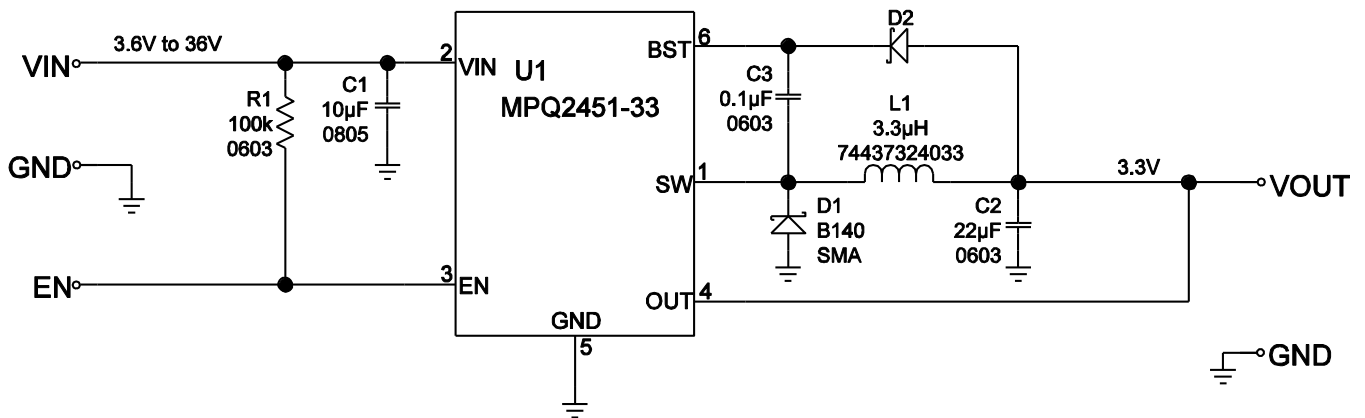
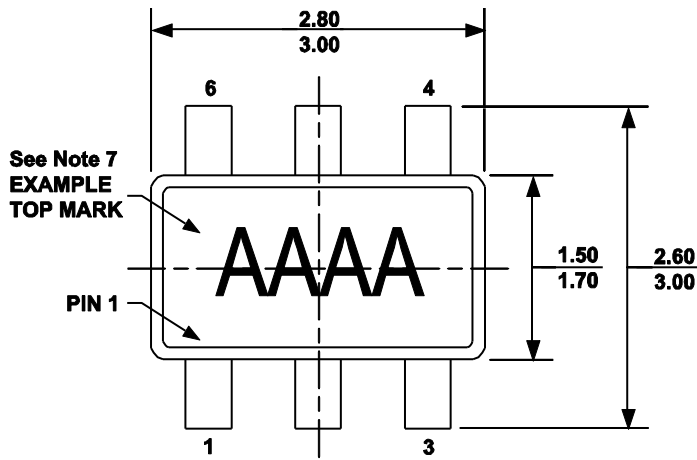

Figure 4: 3.3V Output Typical Application Schematic

PACKAGE INFORMATION

SOT23-6L



TOP VIEW

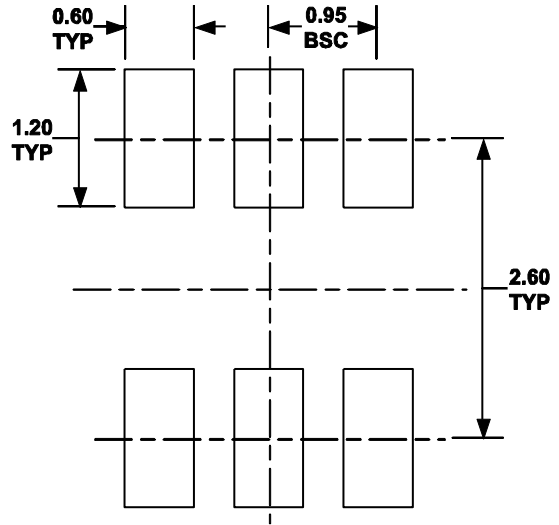

RECOMMENDED LAND PATTERN

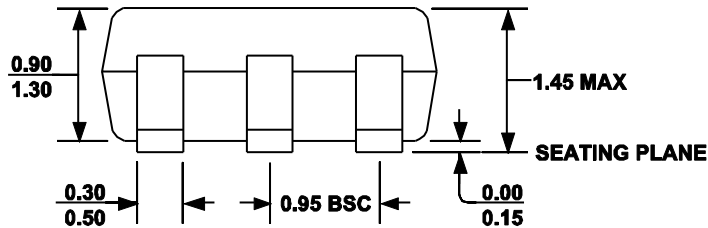

FRONT VIEW

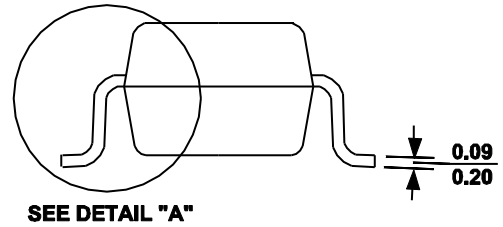

SIDE VIEW

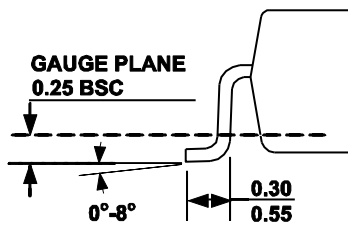

DETAIL "A"

NOTE:

- 1) ALL DIMENSIONS ARE IN MILLIMETERS.
- 2) PACKAGE LENGTH DOES NOT INCLUDE MOLD FLASH, PROTRUSION OR GATE BURR.
- 3) PACKAGE WIDTH DOES NOT INCLUDE INTERLEAD FLASH OR PROTRUSION.
- 4) LEAD COPLANARITY (BOTTOM OF LEADS AFTER FORMING) SHALL BE 0.10 MILLIMETERS MAX.
- 5) DRAWING CONFORMS TO JEDEC MO-178, VARIATION AB.
- 6) DRAWING IS NOT TO SCALE.
- 7) PIN 1 IS LOWER LEFT PIN WHEN READING TOP MARK FROM LEFT TO RIGHT, (SEE EXAMPLE TOP MARK)

QFN6 (2mmx2mm)

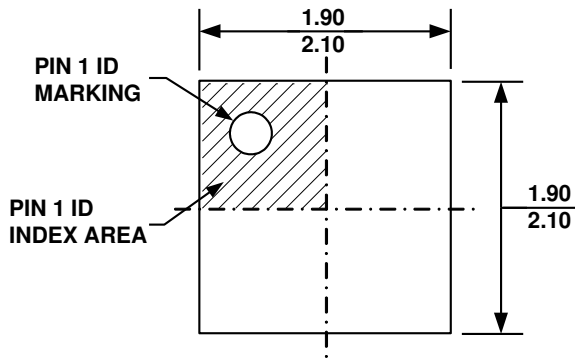

TOP VIEW

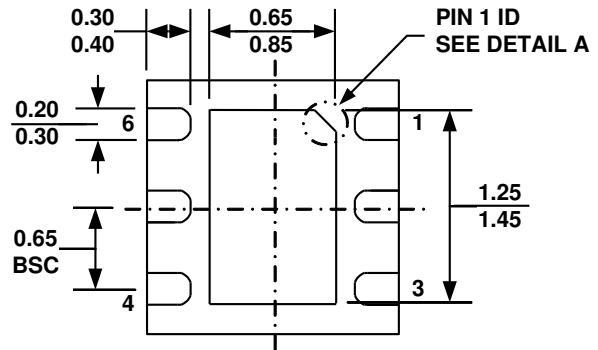

BOTTOM VIEW

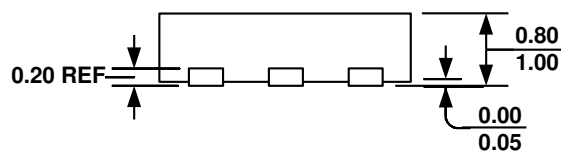

SIDE VIEW

PIN 1 ID OPTION A
0.30x45° TYP.

PIN 1 ID OPTION B
R0.20 TYP.

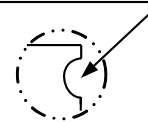
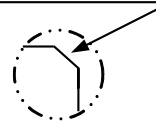

DETAIL A

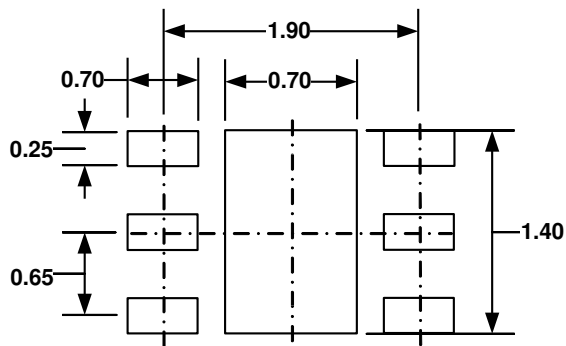

RECOMMENDED LAND PATTERN

NOTICE: The information in this document is subject to change without notice. Users should warrant and guarantee that third party Intellectual Property rights are not infringed upon when integrating MPS products into any application. MPS will not assume any legal responsibility for any said applications.