



Chipsmall Limited consists of a professional team with an average of over 10 year of expertise in the distribution of electronic components. Based in Hongkong, we have already established firm and mutual-benefit business relationships with customers from,Europe,America and south Asia,supplying obsolete and hard-to-find components to meet their specific needs.

With the principle of “Quality Parts,Customers Priority,Honest Operation,and Considerate Service”,our business mainly focus on the distribution of electronic components. Line cards we deal with include Microchip,ALPS,ROHM,Xilinx,Pulse,ON,Everlight and Freescale. Main products comprise IC,Modules,Potentiometer,IC Socket,Relay,Connector.Our parts cover such applications as commercial,industrial, and automotives areas.

We are looking forward to setting up business relationship with you and hope to provide you with the best service and solution. Let us make a better world for our industry!



Contact us

Tel: +86-755-8981 8866 Fax: +86-755-8427 6832

Email & Skype: info@chipsmall.com Web: www.chipsmall.com

Address: A1208, Overseas Decoration Building, #122 Zhenhua RD., Futian, Shenzhen, China



Switching Transistor

NPN Silicon

- This device is available in Pb-free package(s). Specifications herein apply to both standard and Pb-free devices. Please see our website at www.onsemi.com for specific Pb-free orderable part numbers, or contact your local ON Semiconductor sales office or representative.

MAXIMUM RATINGS

Rating	Symbol	Value	Unit
Collector–Emitter Voltage	V_{CEO}	15	Vdc
Collector–Emitter Voltage	V_{CES}	40	Vdc
Collector–Base Voltage	V_{CBO}	40	Vdc
Emitter–Base Voltage	V_{EBO}	5.0	Vdc
Collector Current — Continuous	I_C	300	mAdc
— 10 μ s Pulse		500	
Total Device Dissipation @ $T_A = 25^\circ\text{C}$	P_D	625	mW
Derate above 25°C		5.0	mW/ $^\circ\text{C}$
Total Device Dissipation @ $T_C = 25^\circ\text{C}$	P_D	1.5	Watts
Derate above 25°C		12	mW/ $^\circ\text{C}$
Operating and Storage Junction Temperature Range	T_J, T_{stg}	-55 to +150	$^\circ\text{C}$

THERMAL CHARACTERISTICS

Characteristic	Symbol	Max	Unit
Thermal Resistance, Junction to Ambient	$R_{\theta JA}$	200	$^\circ\text{C}/\text{W}$
Thermal Resistance, Junction to Case	$R_{\theta JC}$	83.3	$^\circ\text{C}/\text{W}$

ELECTRICAL CHARACTERISTICS ($T_A = 25^\circ\text{C}$ unless otherwise noted)

Characteristic	Symbol	Min	Max	Unit
----------------	--------	-----	-----	------

OFF CHARACTERISTICS

Collector–Emitter Breakdown Voltage	($I_C = 100 \mu\text{Adc}, V_{BE} = 0$)	$V_{(BR)CES}$	40	—	Vdc
Collector–Emitter Sustaining Voltage ⁽¹⁾	($I_C = 10 \text{ mAdc}, I_B = 0$)	$V_{CEO(sus)}$	15	—	Vdc
Collector–Base Breakdown Voltage	($I_C = 100 \mu\text{Adc}, I_E = 0$)	$V_{(BR)CBO}$	40	—	Vdc
Emitter–Base Breakdown Voltage	($I_E = 100 \mu\text{Adc}, I_C = 0$)	$V_{(BR)EBO}$	5.0	—	Vdc
Collector Cutoff Current	($V_{CE} = 20 \text{ Vdc}, V_{BE} = 0$) ($V_{CE} = 20 \text{ Vdc}, V_{BE} = 0, T_A = 65^\circ\text{C}$)	I_{CES}	—	0.5	μAdc
			—	3.0	

ON CHARACTERISTICS⁽¹⁾

DC Current Gain	($I_C = 30 \text{ mAdc}, V_{CE} = 0.4 \text{ Vdc}$) ($I_C = 100 \text{ mAdc}, V_{CE} = 0.5 \text{ Vdc}$) ($I_C = 300 \text{ mA}, V_{CE} = 1.0 \text{ Vdc}$)	h_{FE}	30	120	—
			25	—	
			15	—	
Collector–Emitter Saturation Voltage	($I_C = 30 \text{ mAdc}, I_B = 3.0 \text{ mAdc}$) ($I_C = 100 \text{ mAdc}, I_B = 10 \text{ mAdc}$) ($I_C = 300 \text{ mAdc}, I_B = 30 \text{ mAdc}$) ($I_C = 30 \text{ mA}, I_B = 3.0 \text{ mA}, T_A = 65^\circ\text{C}$)	$V_{CE(sat)}$	—	0.2	Vdc
			—	0.28	
			—	0.5	
			—	0.3	
Base–Emitter Saturation Voltage	($I_C = 30 \text{ mAdc}, I_B = 3.0 \text{ mAdc}$) ($I_C = 100 \text{ mAdc}, I_B = 10 \text{ mAdc}$) ($I_C = 300 \text{ mAdc}, I_B = 30 \text{ mA}$)	$V_{BE(sat)}$	0.73	0.95	Vdc
			—	1.2	
			—	1.7	

1. Pulse Test: Pulse Width $\leq 300 \mu\text{s}$; Duty Cycle $\leq 2.0\%$.

Preferred devices are ON Semiconductor recommended choices for future use and best overall value.

MPS3646

ON Semiconductor Preferred Device

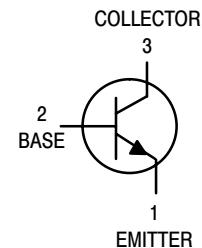
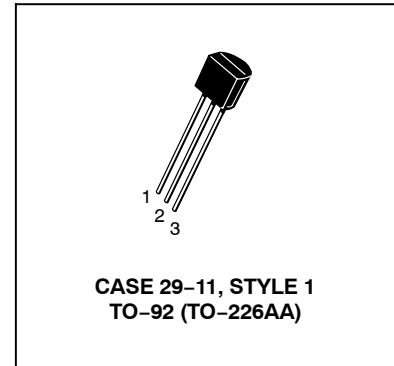

MPS3646

ELECTRICAL CHARACTERISTICS ($T_A = 25^\circ\text{C}$ unless otherwise noted) (Continued)

Characteristic	Symbol	Min	Max	Unit
SMALL-SIGNAL CHARACTERISTICS				
Current-Gain — Bandwidth Product ($I_C = 30\text{ mA}$, $V_{CE} = 10\text{ V}$, $f = 100\text{ MHz}$)	f_T	350	—	MHz
Output Capacitance ($V_{CB} = 5.0\text{ V}$, $I_E = 0$, $f = 1.0\text{ MHz}$)	C_{obo}	—	5.0	pF
Input Capacitance ($V_{EB} = 0.5\text{ V}$, $I_C = 0$, $f = 1.0\text{ MHz}$)	C_{ibo}	—	9.0	pF

SWITCHING CHARACTERISTICS

Turn-On Time	$(V_{CC} = 10\text{ Vdc}$, $I_C = 300\text{ mA}$, $I_{B1} = 30\text{ mA}$) (Figure 1)	t_{on}	—	18	ns
Delay Time		t_d	—	10	ns
Rise Time		t_r	—	15	ns
Turn-Off Time	$(V_{CC} = 10\text{ Vdc}$, $I_C = 300\text{ mA}$, $I_{B1} = I_{B2} = 30\text{ mA}$) (Figure 1)	t_{off}	—	28	ns
Fall Time		t_f	—	15	ns
Storage Time ($V_{CC} = 10\text{ Vdc}$, $I_C = 10\text{ mA}$, $I_{B1} = I_{B2} = 10\text{ mA}$) (Figure 2)		t_s	—	18	ns

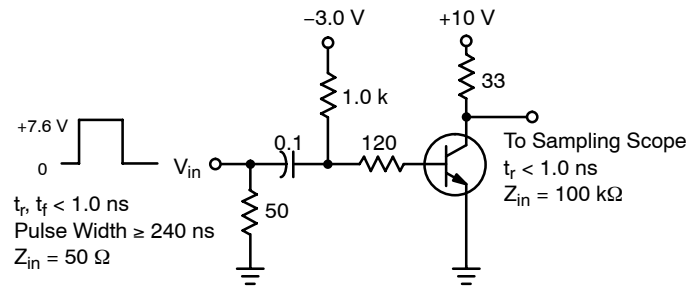

Figure 1. Switching Time Test Circuit

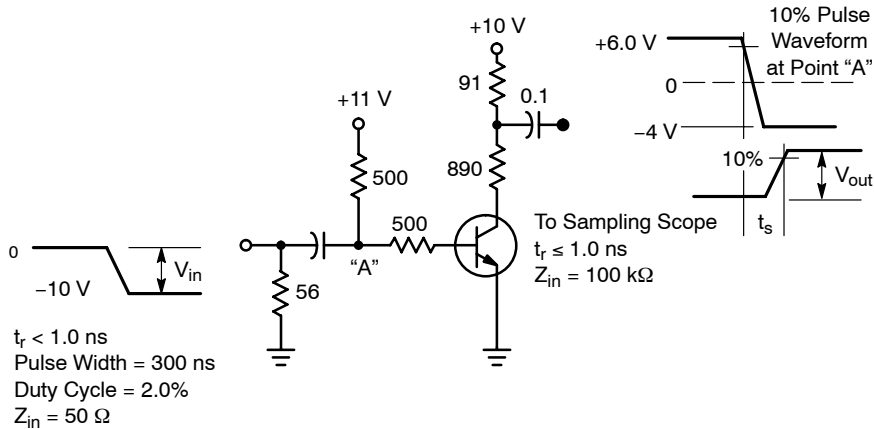

Figure 2. Charge Storage Time Test Circuit

MPS3646

CURRENT GAIN CHARACTERISTICS

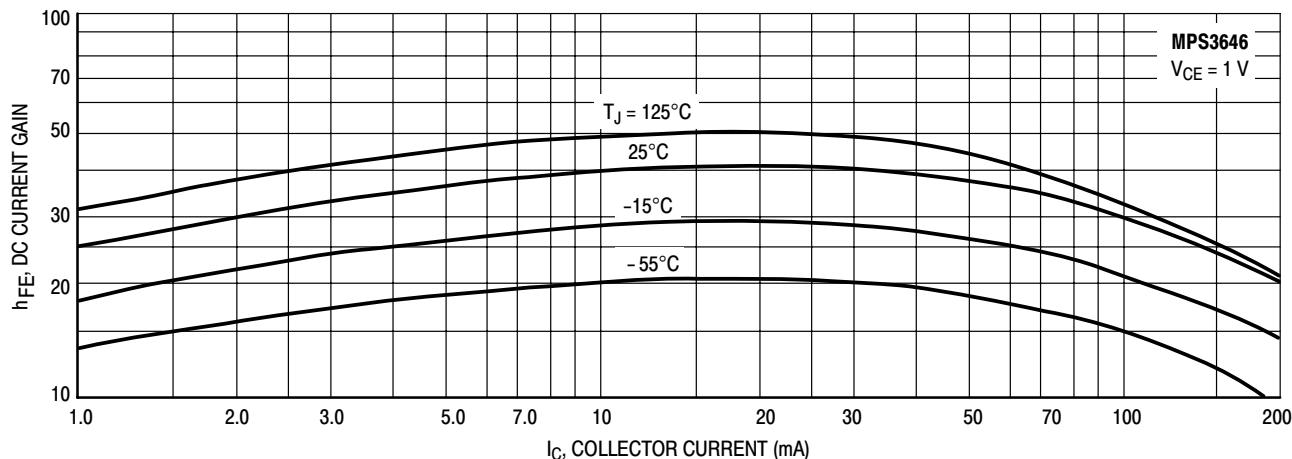

Figure 3. Minimum Current Gain

“ON” CONDITION CHARACTERISTICS

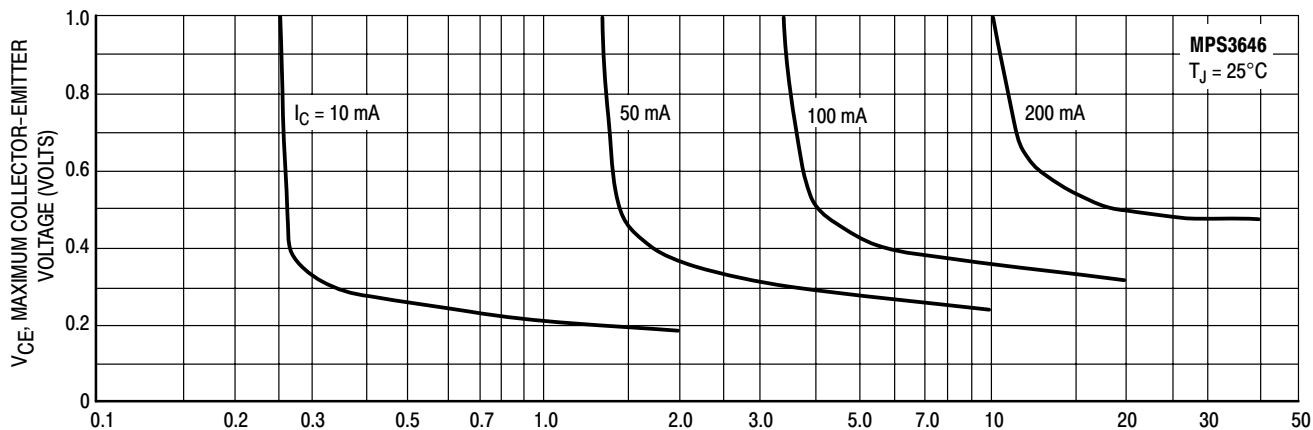

Figure 4. Collector Saturation Region

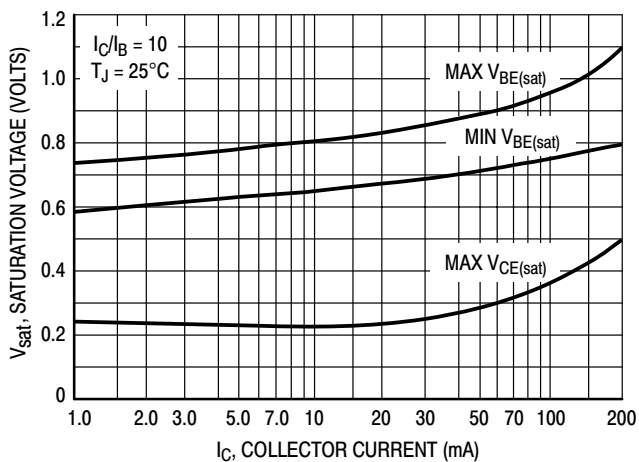

Figure 5. Saturation Voltage Limits

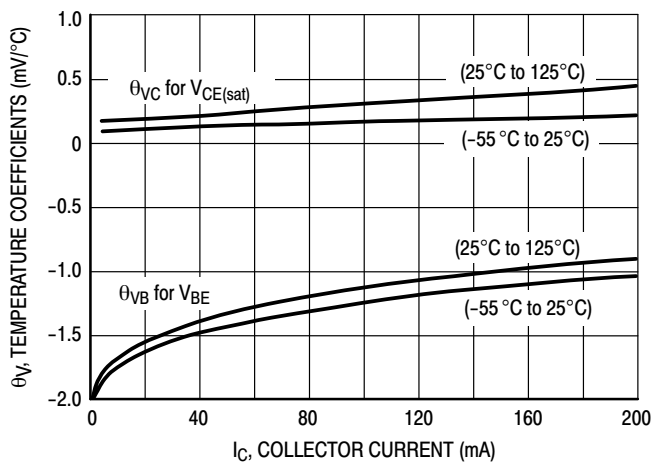

Figure 6. Temperature Coefficients

DYNAMIC CHARACTERISTICS

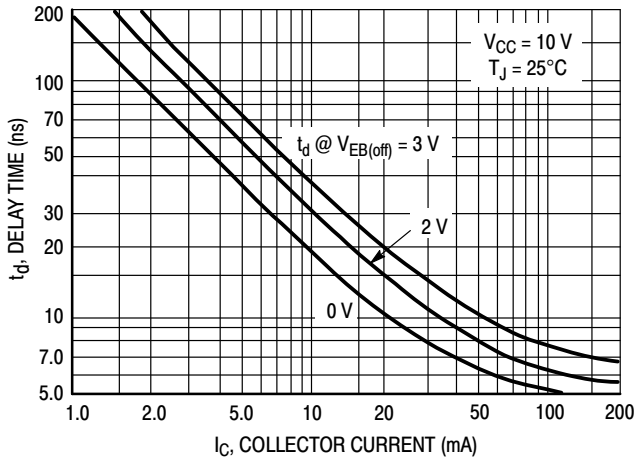

Figure 7. Delay Time

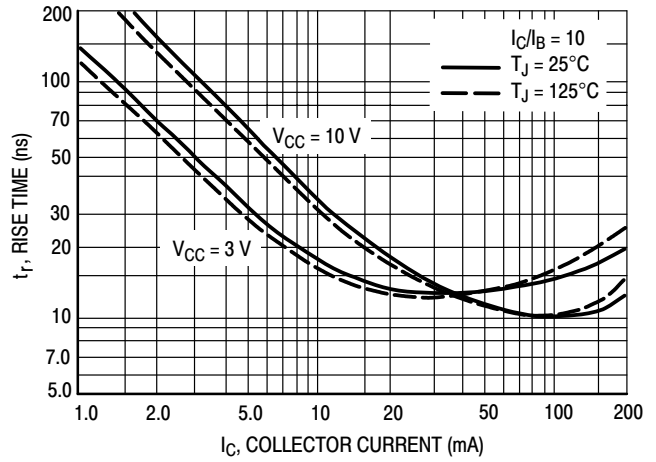

Figure 8. Rise Time

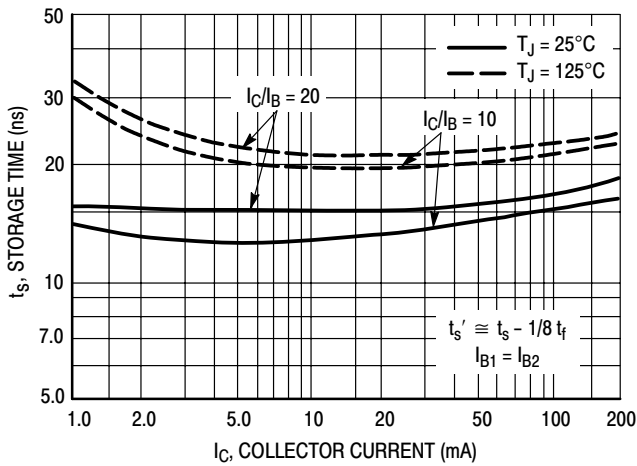

Figure 9. Storage Time

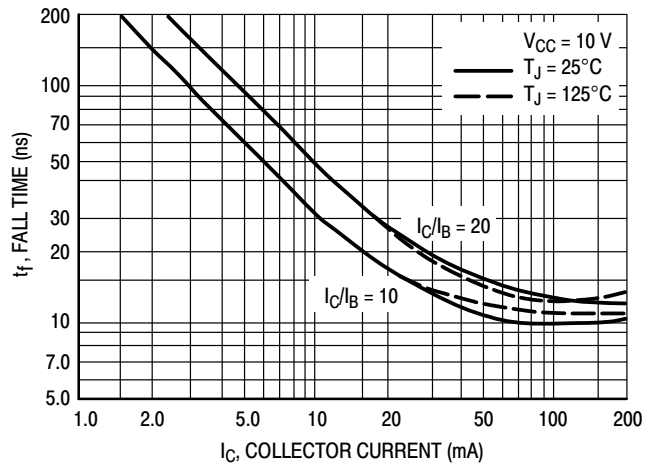

Figure 10. Fall Time

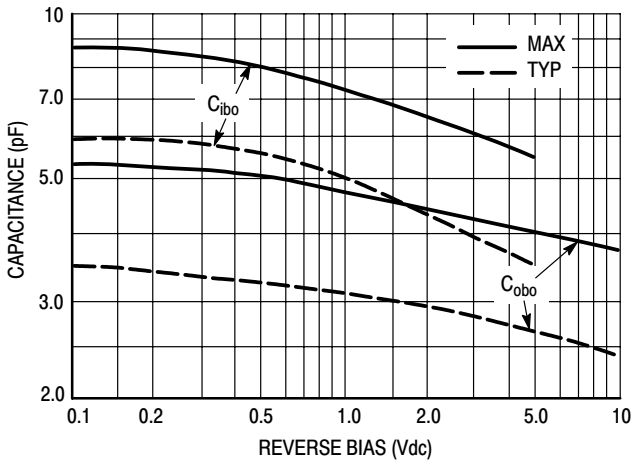

Figure 11. Junction Capacitance

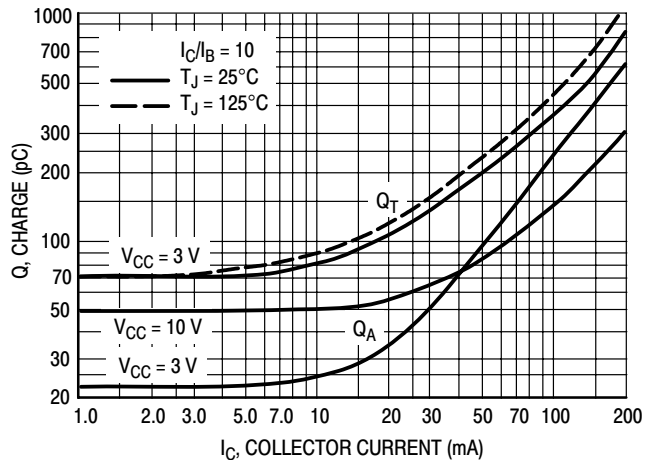
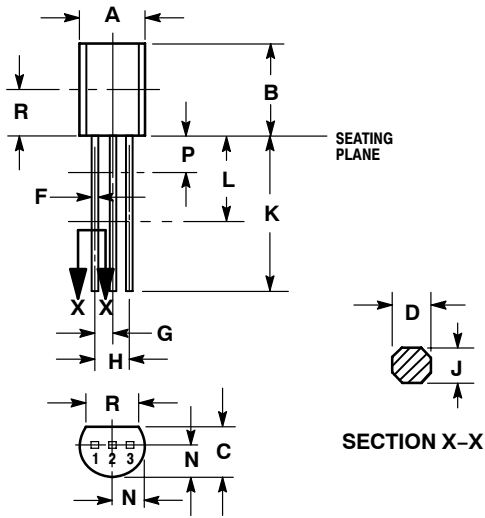

Figure 12. Maximum Charge Data

MPS3646

PACKAGE DIMENSIONS

CASE 029-11 (TO-226AA) ISSUE AD



STYLE 1:
PIN 1. EMITTER
2. BASE
3. COLLECTOR

NOTES:

1. DIMENSIONING AND TOLERANCING PER ANSI Y14.5M, 1982.
2. CONTROLLING DIMENSION: INCH.
3. CONTOUR OF PACKAGE BEYOND DIMENSION R IS UNCONTROLLED.
4. DIMENSION F APPLIES BETWEEN P AND L. DIMENSIONS D AND J APPLY BETWEEN L AND K MINIMUM. LEAD DIMENSION IS UNCONTROLLED IN P AND BEYOND DIMENSION K MINIMUM.

DIM	INCHES		MILLIMETERS	
	MIN	MAX	MIN	MAX
A	0.175	0.205	4.44	5.21
B	0.290	0.310	7.37	7.87
C	0.125	0.165	3.18	4.19
D	0.018	0.021	0.457	0.533
F	0.016	0.019	0.407	0.482
G	0.045	0.055	1.15	1.39
H	0.095	0.105	2.42	2.66
J	0.018	0.024	0.46	0.61
K	0.500	---	12.70	---
L	0.250	---	6.35	---
N	0.080	0.105	2.04	2.66
P	---	0.100	---	2.54
R	0.135	---	3.43	---

Notes

Notes

ON Semiconductor and  are registered trademarks of Semiconductor Components Industries, LLC (SCILLC). SCILLC reserves the right to make changes without further notice to any products herein. SCILLC makes no warranty, representation or guarantee regarding the suitability of its products for any particular purpose, nor does SCILLC assume any liability arising out of the application or use of any product or circuit, and specifically disclaims any and all liability, including without limitation special, consequential or incidental damages. "Typical" parameters which may be provided in SCILLC data sheets and/or specifications can and do vary in different applications and actual performance may vary over time. All operating parameters, including "Typicals" must be validated for each customer application by customer's technical experts. SCILLC does not convey any license under its patent rights nor the rights of others. SCILLC products are not designed, intended, or authorized for use as components in systems intended for surgical implant into the body, or other applications intended to support or sustain life, or for any other application in which the failure of the SCILLC product could create a situation where personal injury or death may occur. Should Buyer purchase or use SCILLC products for any such unintended or unauthorized application, Buyer shall indemnify and hold SCILLC and its officers, employees, subsidiaries, affiliates, and distributors harmless against all claims, costs, damages, and expenses, and reasonable attorney fees arising out of, directly or indirectly, any claim of personal injury or death associated with such unintended or unauthorized use, even if such claim alleges that SCILLC was negligent regarding the design or manufacture of the part. SCILLC is an Equal Opportunity/Affirmative Action Employer. This literature is subject to all applicable copyright laws and is not for resale in any manner.

PUBLICATION ORDERING INFORMATION

LITERATURE FULFILLMENT:

Literature Distribution Center for ON Semiconductor
P.O. Box 61312, Phoenix, Arizona 85082-1312 USA
Phone: 480-829-7710 or 800-344-3860 Toll Free USA/Canada
Fax: 480-829-7709 or 800-344-3867 Toll Free USA/Canada
Email: orderlit@onsemi.com

N. American Technical Support: 800-282-9855 Toll Free
USA/Canada

Japan: ON Semiconductor, Japan Customer Focus Center
2-9-1 Kamimeguro, Meguro-ku, Tokyo, Japan 153-0051
Phone: 81-3-5773-3850

ON Semiconductor Website: <http://onsemi.com>

Order Literature: <http://www.onsemi.com/litorder>

For additional information, please contact your
local Sales Representative.