



Chipsmall Limited consists of a professional team with an average of over 10 year of expertise in the distribution of electronic components. Based in Hongkong, we have already established firm and mutual-benefit business relationships with customers from,Europe,America and south Asia,supplying obsolete and hard-to-find components to meet their specific needs.

With the principle of “Quality Parts,Customers Priority,Honest Operation,and Considerate Service”,our business mainly focus on the distribution of electronic components. Line cards we deal with include Microchip,ALPS,ROHM,Xilinx,Pulse,ON,Everlight and Freescale. Main products comprise IC,Modules,Potentiometer,IC Socket,Relay,Connector.Our parts cover such applications as commercial,industrial, and automotives areas.

We are looking forward to setting up business relationship with you and hope to provide you with the best service and solution. Let us make a better world for our industry!



Contact us

Tel: +86-755-8981 8866 Fax: +86-755-8427 6832

Email & Skype: info@chipsmall.com Web: www.chipsmall.com

Address: A1208, Overseas Decoration Building, #122 Zhenhua RD., Futian, Shenzhen, China





Chip beads

For power line

MPZ series

MPZ0402_{type}

MPZ0402

0402[01005 inch]*

* Dimensions code: JIS[EIA]

REMINDERS FOR USING THESE PRODUCTS

Before using these products, be sure to request the delivery specifications.

SAFETY REMINDERS

Please pay sufficient attention to the warnings for safe designing when using this products.

REMINDERS

- The storage period is less than 12 months. Be sure to follow the storage conditions (temperature: 5 to 40°C, humidity: 10 to 75% RH or less).
If the storage period elapses, the soldering of the terminal electrodes may deteriorate.
- Do not use or store in locations where there are conditions such as gas corrosion (salt, acid, alkali, etc.).
- Before soldering, be sure to preheat components.
The preheating temperature should be set so that the temperature difference between the solder temperature and chip temperature does not exceed 150°C.
- Soldering corrections after mounting should be within the range of the conditions determined in the specifications.
If overheated, a short circuit, performance deterioration, or lifespan shortening may occur.
- When embedding a printed circuit board where a chip is mounted to a set, be sure that residual stress is not given to the chip due to the overall distortion of the printed circuit board and partial distortion such as at screw tightening portions.
- Self heating (temperature increase) occurs when the power is turned ON, so the tolerance should be sufficient for the set thermal design.
- Carefully lay out the coil for the circuit board design of the non-magnetic shield type.
A malfunction may occur due to magnetic interference.
- Use a wrist band to discharge static electricity in your body through the grounding wire.
- Do not expose the products to magnets or magnetic fields.
- Do not use for a purpose outside of the contents regulated in the delivery specifications.
- The products listed on this catalog are intended for use in general electronic equipment (AV equipment, telecommunications equipment, home appliances, amusement equipment, computer equipment, personal equipment, office equipment, measurement equipment, industrial robots) under a normal operation and use condition.
The products are not designed or warranted to meet the requirements of the applications listed below, whose performance and/or quality require a more stringent level of safety or reliability, or whose failure, malfunction or trouble could cause serious damage to society, person or property.
If you intend to use the products in the applications listed below or if you have special requirements exceeding the range or conditions set forth in the each catalog, please contact us.

- (1) Aerospace/aviation equipment
- (2) Transportation equipment (cars, electric trains, ships, etc.)
- (3) Medical equipment
- (4) Power-generation control equipment
- (5) Atomic energy-related equipment
- (6) Seabed equipment
- (7) Transportation control equipment

- (8) Public information-processing equipment
- (9) Military equipment
- (10) Electric heating apparatus, burning equipment
- (11) Disaster prevention/crime prevention equipment
- (12) Safety equipment
- (13) Other applications that are not considered general-purpose applications

When designing your equipment even for general-purpose applications, you are kindly requested to take into consideration securing protection circuit/device or providing backup circuits in your equipment.

Chip beads

For power line

Product compatible with RoHS directive
Halogen-free
Compatible with lead-free solders

Overview of MPZ0402 series

FEATURES

- Noise reduction solution for power line.
- Compared to the MMZ series, has low direct current resistance for compatibility with large currents, optimal for low power consumption.
- Performs well even in signal lines where low direct current resistance is required.

APPLICATION

- Noise removal for mobile devices such as smartphones and tablet terminals, and various modules.
- Noise removal for PCs and recorders, household appliances such as STBs, smart grids, and industrial equipment.

PART NUMBER CONSTRUCTION

MPZ	0402	S	100	C	T	000				
Series name	LxWxT dimensions (mm)		Material name	Impedance (Ω) at 100MHz		Characteristic type	Packaging style		Internal code	
	0402	0.4x0.2x0.2	S	100	10	C	T	Taping	000	W8P2 Paper carrier
				330	33				F0W	W4P1 Plastic carrier

OPERATING TEMPERATURE RANGE, PACKAGE QUANTITY, PRODUCT WEIGHT

Type	Temperature range		Package quantity (pieces/reel)	Individual weight (mg)
	Operating temperature (°C)	Storage temperature* (°C)		
MPZ0402**T000 (W8P2 Paper carrier)	-55 to +125	-55 to +125	20,000	0.08
MPZ0402**TF0W (W4P1 Plastic carrier)			40,000	

* The storage temperature range is for after the circuit board is mounted.

- RoHS Directive Compliant Product: See the following for more details. <https://product.tdk.com/info/en/environment/rohs/index.html>
- Halogen-free: indicates that Cl content is less than 900ppm, Br content is less than 900ppm, and that the total Cl and Br content is less than 1500ppm.

 Please be sure to request delivery specifications that provide further details on the features and specifications of the products for proper and safe use.
Please note that the contents may change without any prior notice due to reasons such as upgrading.

MPZ0402 type

RECOMMENDED REFLOW PROFILE

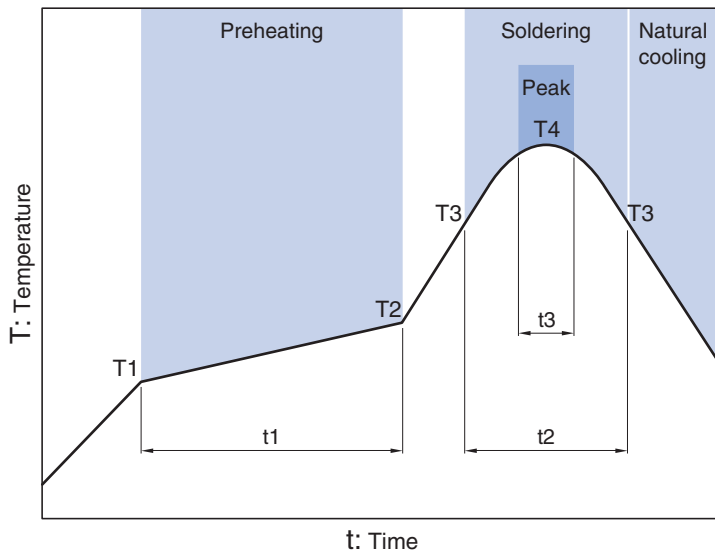

Preheating			Soldering		Peak	
Temp.		Time	Temp.	Time	Temp.	Time
T1	T2	t1	T3	t2	T4	t3
150°C	180°C	60 to 120s	230°C	30 to 60s	250 to 260°C	10s

MPZ0402 type

■ MATERIAL CHARACTERISTIC

S material: Standard type that features impedance characteristics similar to those of a typical ferrite core. For power line applications in which the blocking region is near 100MHz. Impedance values selected for effectiveness at 40 to 300MHz.

■ TYPICAL MATERIAL IMPEDANCE CHARACTERISTICS

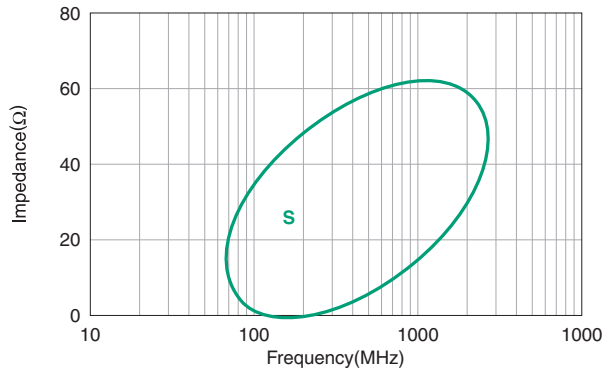

MPZ0402 type

SHAPE & DIMENSIONS

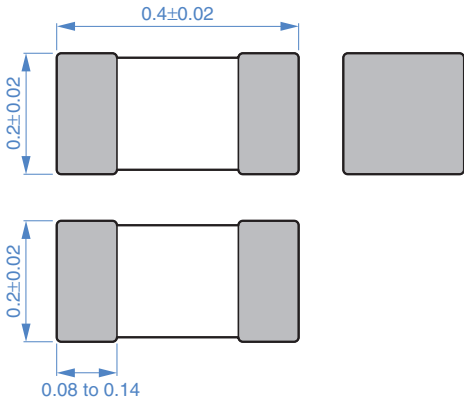

Dimensions in mm

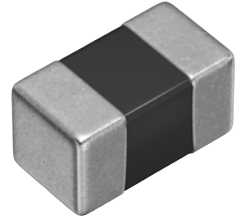

RECOMMENDED LAND PATTERN

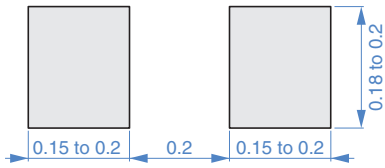

Dimensions in mm

 Please be sure to request delivery specifications that provide further details on the features and specifications of the products for proper and safe use. Please note that the contents may change without any prior notice due to reasons such as upgrading.

MPZ0402 type

ELECTRICAL CHARACTERISTICS

CHARACTERISTICS SPECIFICATION TABLE

Impedance [100MHz] (Ω)	Tolerance	DC resistance (Ω)	Rated current* (A)	Part No.
10	$\pm 5\Omega$	0.05	1.10	MPZ0402S100CT000 MPZ0402S100CTF0W
22	$\pm 25\%$	0.15	0.75	MPZ0402S220CT000 MPZ0402S220CTF0W
33	$\pm 25\%$	0.2	0.55	MPZ0402S330CT000 MPZ0402S330CTF0W

* Please refer to the graph of rated current vs. temperature characteristics (derating) about the rating current at 85°C or more in temperature of the product.

Measurement equipment

Measurement item	Product No.	Manufacturer
Impedance	E4991A+16196D	Keysight Technologies
DC resistance	Type-7556	Yokogawa

* Equivalent measurement equipment may be used.

Rated current vs. temperature characteristics (derating)

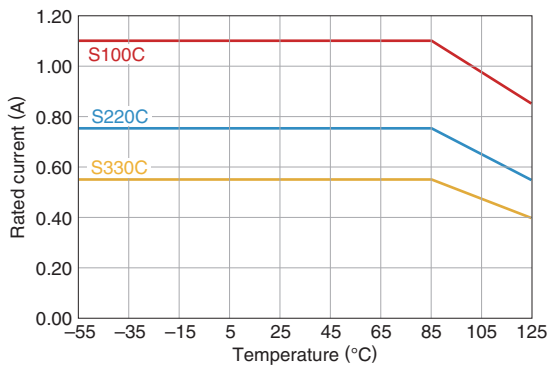

MPZ0402 type

ELECTRICAL CHARACTERISTICS

Z VS. FREQUENCY CHARACTERISTICS (BY SERIES)

MPZ0402 series

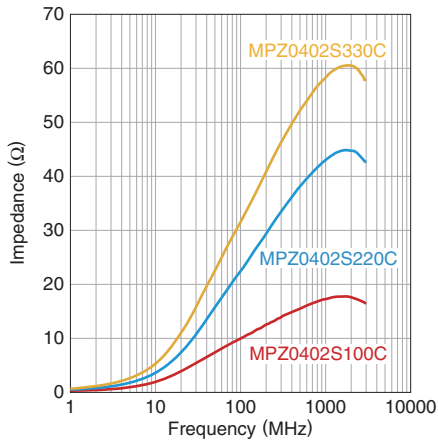

MPZ0402 type

ELECTRICAL CHARACTERISTICS

Z, X, R VS. FREQUENCY CHARACTERISTICS

MPZ0402S100CT

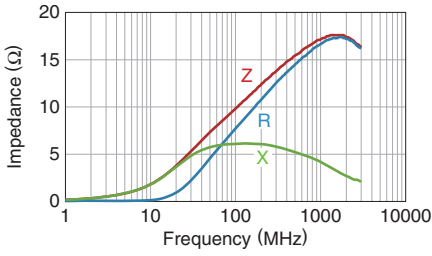

MPZ0402S220CT

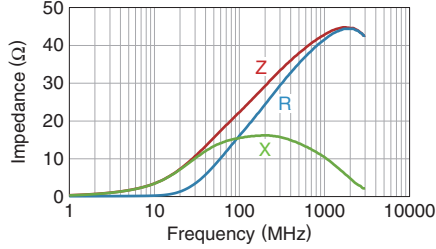

MPZ0402S330CT

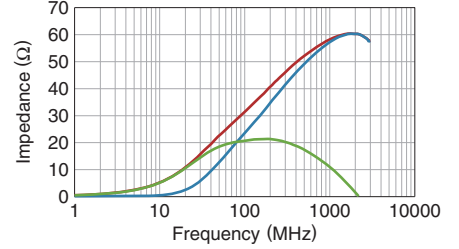

 Please be sure to request delivery specifications that provide further details on the features and specifications of the products for proper and safe use. Please note that the contents may change without any prior notice due to reasons such as upgrading.

MPZ0402 type

PACKAGING STYLE

REEL DIMENSIONS

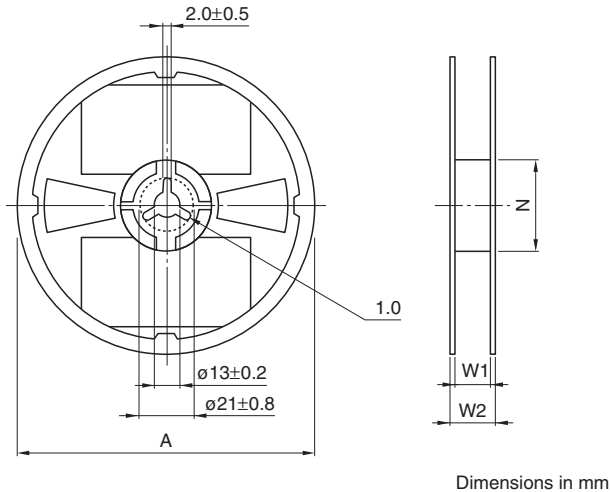

Type	Package specifications	A	W1	W2	N
MPZ0402**T000	Paper carrier(W8P2)	$\phi 180 \pm 2.0$	$8.4 + 2.0, -0.0$	14.4max.	$\phi 60$ min.
MPZ0402**TF0W	Plastic carrier(W4P1)	$\phi 178 \pm 2.0$	5.0 ± 1.0	—	$\phi 60 \pm 2.0$

TAPE DIMENSIONS

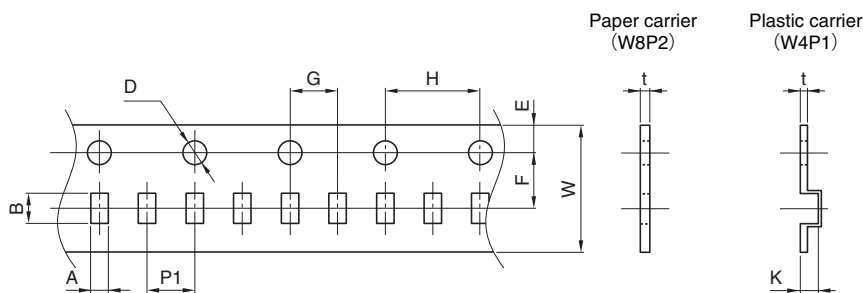

Type	Package specifications	W	P1	A	B	D	E	F	G	H	t	K
MPZ0402**T000	Paper carrier (W8P2)	8.0 ± 0.3	2.0 ± 0.05	0.26 ± 0.04	0.46 ± 0.04	1.55 ± 0.02	1.75 ± 0.03	3.50 ± 0.05	2.0 ± 0.05	4.0 ± 0.10	0.4max.	—
MPZ0402**TF0W	Plastic carrier (W4P1)	4.0 ± 0.1	1.0 ± 0.04	0.24 ± 0.04	0.44 ± 0.04	0.80 ± 0.08	0.90 ± 0.10	1.80 ± 0.04	1.0 ± 0.04	2.0 ± 0.08	0.3max.	0.29max.

