



Chipsmall Limited consists of a professional team with an average of over 10 year of expertise in the distribution of electronic components. Based in Hongkong, we have already established firm and mutual-benefit business relationships with customers from,Europe,America and south Asia,supplying obsolete and hard-to-find components to meet their specific needs.

With the principle of “Quality Parts,Customers Priority,Honest Operation,and Considerate Service”,our business mainly focus on the distribution of electronic components. Line cards we deal with include Microchip,ALPS,ROHM,Xilinx,Pulse,ON,Everlight and Freescale. Main products comprise IC,Modules,Potentiometer,IC Socket,Relay,Connector.Our parts cover such applications as commercial,industrial, and automotives areas.

We are looking forward to setting up business relationship with you and hope to provide you with the best service and solution. Let us make a better world for our industry!



Contact us

Tel: +86-755-8981 8866 Fax: +86-755-8427 6832

Email & Skype: info@chipsmall.com Web: www.chipsmall.com

Address: A1208, Overseas Decoration Building, #122 Zhenhua RD., Futian, Shenzhen, China



MR9232 series

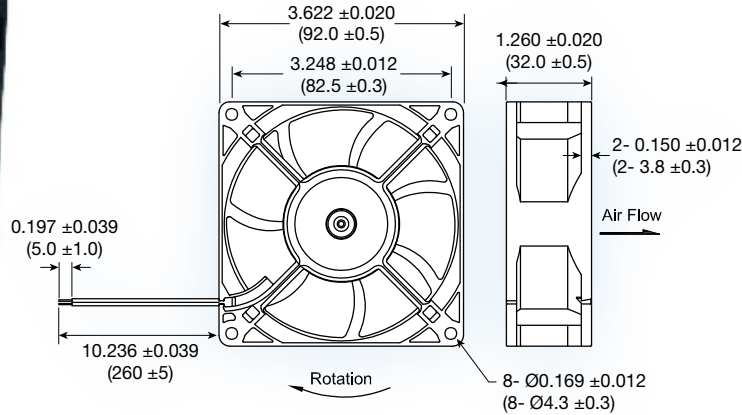

(92 x 92 x 32 mm)

3.62 x 3.62 x 1.26 inches

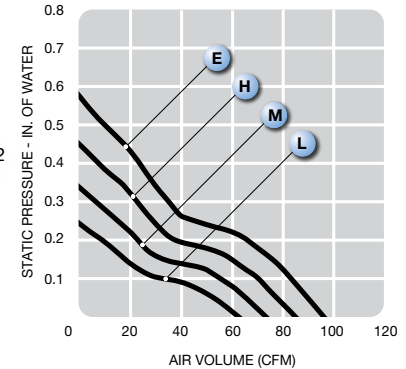

Features: soft start, polarity protection, auto-restart

Operating Voltage: 12 or 24 VDC

Construction: UL94V-0 plastic impeller and frame

Bearing option: ball bearing or sleeve

Air Flow: air exhaust over struts

Options: tachometer output or locked rotor alarm signal; PWM speed control

Model No.	Rated Voltage VDC	Current A		Speed RPM	Air Volume		Max. Static Pressure (H ₂ O)		Sound Noise dba	Weight g
		12	24		M ³ /Min.	CFM	MM	INCH		
MR9232L	12/24	0.31	0.16	3,200	1.75	62	6.16	0.24	43.0	150
MR9232M	12/24	0.46	0.23	3,800	2.07	74	8.61	0.34	48.8	150
MR9232H	12/24	0.60	0.30	4,400	2.39	85	11.46	0.45	49.7	150
MR9232E	12/24	0.98	0.49	5,000	2.71	96	14.72	0.58	52.8	150