



Chipsmall Limited consists of a professional team with an average of over 10 year of expertise in the distribution of electronic components. Based in Hongkong, we have already established firm and mutual-benefit business relationships with customers from,Europe,America and south Asia,supplying obsolete and hard-to-find components to meet their specific needs.

With the principle of “Quality Parts,Customers Priority,Honest Operation,and Considerate Service”,our business mainly focus on the distribution of electronic components. Line cards we deal with include Microchip,ALPS,ROHM,Xilinx,Pulse,ON,Everlight and Freescale. Main products comprise IC,Modules,Potentiometer,IC Socket,Relay,Connector.Our parts cover such applications as commercial,industrial, and automotives areas.

We are looking forward to setting up business relationship with you and hope to provide you with the best service and solution. Let us make a better world for our industry!



## Contact us

Tel: +86-755-8981 8866 Fax: +86-755-8427 6832

Email & Skype: info@chipsmall.com Web: www.chipsmall.com

Address: A1208, Overseas Decoration Building, #122 Zhenhua RD., Futian, Shenzhen, China



# RF Power Field-Effect Transistor

## N-Channel Enhancement-Mode Lateral MOSFET

Designed for broadband commercial and industrial applications with frequencies from 470 to 860 MHz. The high gain and broadband performance of these devices make them ideal for large-signal, common source amplifier applications in 32 volt digital television transmitter equipment.

- Typical Broadband DVBT OFDM Performance @ 470-860 MHz, 32 Volts,  $I_{DQ} = 2000$  mA, 8K Mode, 64 QAM  
Output Power — 45 Watts Avg.  
Power Gain  $\geq 16.7$  dB  
Drain Efficiency  $\geq 21\%$   
ACPR  $\leq -58$  dBc
- Typical Broadband ATSC 8VSB Performance @ 470-860 MHz, 32 Volts,  $I_{DQ} = 2000$  mA  
Output Power — 80 Watts Avg.  
Power Gain  $\geq 16.5$  dB  
Drain Efficiency  $\geq 27.5\%$   
IMD  $\geq -31.3$  dBc
- Capable of Handling 10:1 VSWR, @ 32 Vdc, 860 MHz, 45 Watts CW Output Power

### Features

- Characterized with Series Equivalent Large-Signal Impedance Parameters
- Internally Matched for Ease of Use
- Device Designed for Push-Pull Operation Only
- Integrated ESD Protection
- Excellent Thermal Stability
- Lower Thermal Resistance Package
- Low Gold Plating Thickness on Leads, 40 $\mu$ ” Nominal.
- RoHS Compliant
- In Tape and Reel. R3 Suffix = 250 Units per 56 mm, 13 inch Reel.

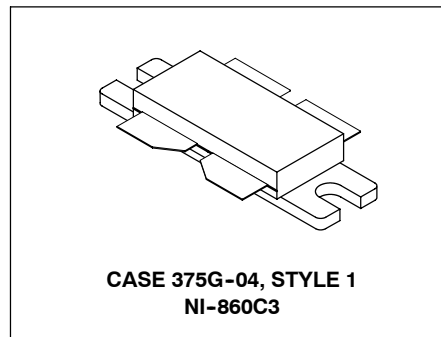
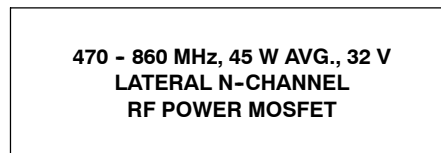
**Table 1. Maximum Ratings**

Rating	Symbol	Value	Unit
Drain-Source Voltage	$V_{DSS}$	- 0.5, +65	Vdc
Gate-Source Voltage	$V_{GS}$	- 0.5, +15	Vdc
Drain Current - Continuous	$I_D$	17	Adc
Total Device Dissipation @ $T_C = 25^\circ\text{C}$ Derate above 25 $^\circ\text{C}$	$P_D$	648 3.7	W W/ $^\circ\text{C}$
Storage Temperature Range	$T_{stg}$	- 65 to +150	$^\circ\text{C}$
Case Operating Temperature	$T_C$	150	$^\circ\text{C}$
Operating Junction Temperature	$T_J$	200	$^\circ\text{C}$
CW Operation @ $T_C = 25^\circ\text{C}$ Derate above 25 $^\circ\text{C}$	CW	235 1.38	W W/ $^\circ\text{C}$

**Table 2. Thermal Characteristics**

Characteristic	Symbol	Value (1,2)	Unit
Thermal Resistance, Junction to Case Case Temperature 81 $^\circ\text{C}$ , 105 W CW Case Temperature 77 $^\circ\text{C}$ , 45 W CW	$R_{\theta JC}$	0.27 0.29	$^\circ\text{C}/\text{W}$

1. MTTF calculator available at <http://www.freescale.com/rf>. Select Software & Tools/Development Tools/Calculators to access MTTF calculators by product.
2. Refer to AN1955, Thermal Measurement Methodology of RF Power Amplifiers. Go to <http://www.freescale.com/rf>. Select Documentation/Application Notes - AN1955.



LIFETIME BUY

LAST SHIP 30 JUN 12  
LAST ORDER 1 JUL 11

**Table 3. ESD Protection Characteristics**

Test Conditions	Class
Human Body Model	1 (Minimum)
Machine Model	M3 (Minimum)
Charge Device Model	7 (Minimum)

**Table 4. Electrical Characteristics** ( $T_C = 25^\circ\text{C}$  unless otherwise noted)

Characteristic	Symbol	Min	Typ	Max	Unit
<b>Off Characteristics</b> <sup>(1)</sup>					
Drain-Source Breakdown Voltage <sup>(4)</sup> ( $V_{GS} = 0\text{ Vdc}$ , $I_D = 10\ \mu\text{A}$ )	$V_{(BR)DSS}$	65	—	—	Vdc
Zero Gate Voltage Drain Current <sup>(4)</sup> ( $V_{DS} = 32\text{ Vdc}$ , $V_{GS} = 0\text{ Vdc}$ )	$I_{DSS}$	—	—	1	$\mu\text{Adc}$
Gate-Source Leakage Current ( $V_{GS} = 5\text{ Vdc}$ , $V_{DS} = 0\text{ Vdc}$ )	$I_{GSS}$	—	—	1	$\mu\text{Adc}$
Gate Threshold Voltage ( $V_{DS} = 10\text{ Vdc}$ , $I_D = 200\ \mu\text{A}$ )	$V_{GS(th)}$	—	2.8	—	Vdc
<b>On Characteristics</b>					
Gate Quiescent Voltage <sup>(3)</sup> ( $V_{DS} = 32\text{ Vdc}$ , $I_D = 2000\text{ mAdc}$ )	$V_{GS(Q)}$	2.5	3.5	4.5	Vdc
Drain-Source On-Voltage <sup>(1)</sup> ( $V_{GS} = 10\text{ Vdc}$ , $I_D = 3\text{ A}$ )	$V_{DS(on)}$	—	0.27	—	Vdc
<b>Dynamic Characteristics</b> <sup>(1,2)</sup>					
Reverse Transfer Capacitance ( $V_{DS} = 28\text{ Vdc}$ , $V_{GS} = 0$ , $f = 1\text{ MHz}$ )	$C_{rss}$	—	3.2	—	pF
<b>Functional Tests</b> <sup>(3)</sup> (In DVBT OFDM Single-Channel, Narrowband Fixture, 50 ohm system)					
Common Source Power Gain ( $V_{DD} = 32\text{ Vdc}$ , $P_{out} = 45\text{ W Avg.}$ , $I_{DQ} = 2000\text{ mA}$ , $f = 860\text{ MHz}$ )	$G_{ps}$	16.5	18.2	—	dB
Drain Efficiency ( $V_{DD} = 32\text{ Vdc}$ , $P_{out} = 45\text{ W Avg.}$ , $I_{DQ} = 2000\text{ mA}$ , $f = 860\text{ MHz}$ )	$\eta_D$	21	22.9	—	%
Adjacent Channel Power Ratio ( $V_{DD} = 32\text{ Vdc}$ , $P_{out} = 45\text{ W Avg.}$ , $I_{DQ} = 2000\text{ mA}$ , $f = 860\text{ MHz}$ )	ACPR	—	-59.2	-57	dBc
<b>Typical Performances</b> <sup>(3)</sup> (In DVBT OFDM Single-Channel, Broadband Fixture, 50 ohm system)					
Common Source Power Gain ( $V_{DD} = 32\text{ Vdc}$ , $P_{out} = 45\text{ W Avg.}$ , $I_{DQ} = 2000\text{ mA}$ )	$G_{ps}$				dB
$f = 470\text{ MHz}$		—	17.6	—	
$f = 560\text{ MHz}$		—	17.6	—	
$f = 660\text{ MHz}$		—	17.4	—	
$f = 760\text{ MHz}$		—	17.4	—	
$f = 860\text{ MHz}$		—	16.8	—	

- Each side of device measured separately.
- Part is internally matched both on input and output.
- Measurement made with device in push-pull configuration.
- Drains are tied together internally as this is a total device value.

(continued)

**Table 4. Electrical Characteristics** ( $T_C = 25^\circ\text{C}$  unless otherwise noted) (continued)

Characteristic	Symbol	Min	Typ	Max	Unit
Drain Efficiency ( $V_{DD} = 32\text{ Vdc}$ , $P_{out} = 45\text{ W Avg.}$ , $I_{DQ} = 2000\text{ mA}$ )	$\eta_D$				%
f = 470 MHz		—	23.5	—	
f = 560 MHz		—	25.8	—	
f = 660 MHz		—	23.0	—	
f = 760 MHz		—	22.7	—	
f = 860 MHz		—	21.3	—	
Adjacent Channel Power Ratio ( $V_{DD} = 32\text{ Vdc}$ , $P_{out} = 45\text{ W Avg.}$ , $I_{DQ} = 2000\text{ mA}$ )	ACPR				dBc
f = 470 MHz		—	-59.3	—	
f = 560 MHz		—	-59.3	—	
f = 660 MHz		—	-58.7	—	
f = 760 MHz		—	-58.7	—	
f = 860 MHz		—	-58.1	—	

**Typical Performances** <sup>(1)</sup> (In ATSC 8VSB Single-Channel, Broadband Fixture, 50 ohm system)

Common Source Power Gain ( $V_{DD} = 32\text{ Vdc}$ , $P_{out} = 80\text{ W Avg.}$ , $I_{DQ} = 2000\text{ mA}$ )	$G_{ps}$				dB
f = 470 MHz		—	17.5	—	
f = 560 MHz		—	17.5	—	
f = 660 MHz		—	17.2	—	
f = 760 MHz		—	17.2	—	
f = 860 MHz		—	16.6	—	
Drain Efficiency ( $V_{DD} = 32\text{ Vdc}$ , $P_{out} = 80\text{ W Avg.}$ , $I_{DQ} = 2000\text{ mA}$ )	$\eta_D$				%
f = 470 MHz		—	31.0	—	
f = 560 MHz		—	34.3	—	
f = 660 MHz		—	30.1	—	
f = 760 MHz		—	29.6	—	
f = 860 MHz		—	27.8	—	
Intermodulation Distortion ( $V_{DD} = 32\text{ Vdc}$ , $P_{out} = 80\text{ W Avg.}$ , $I_{DQ} = 2000\text{ mA}$ )	IMD				dBc
f = 470 MHz		—	31.7	—	
f = 560 MHz		—	32.7	—	
f = 660 MHz		—	32.9	—	
f = 760 MHz		—	34.2	—	
f = 860 MHz		—	35.4	—	

1. Measurement made with device in push-pull configuration.

LIFETIME BUY

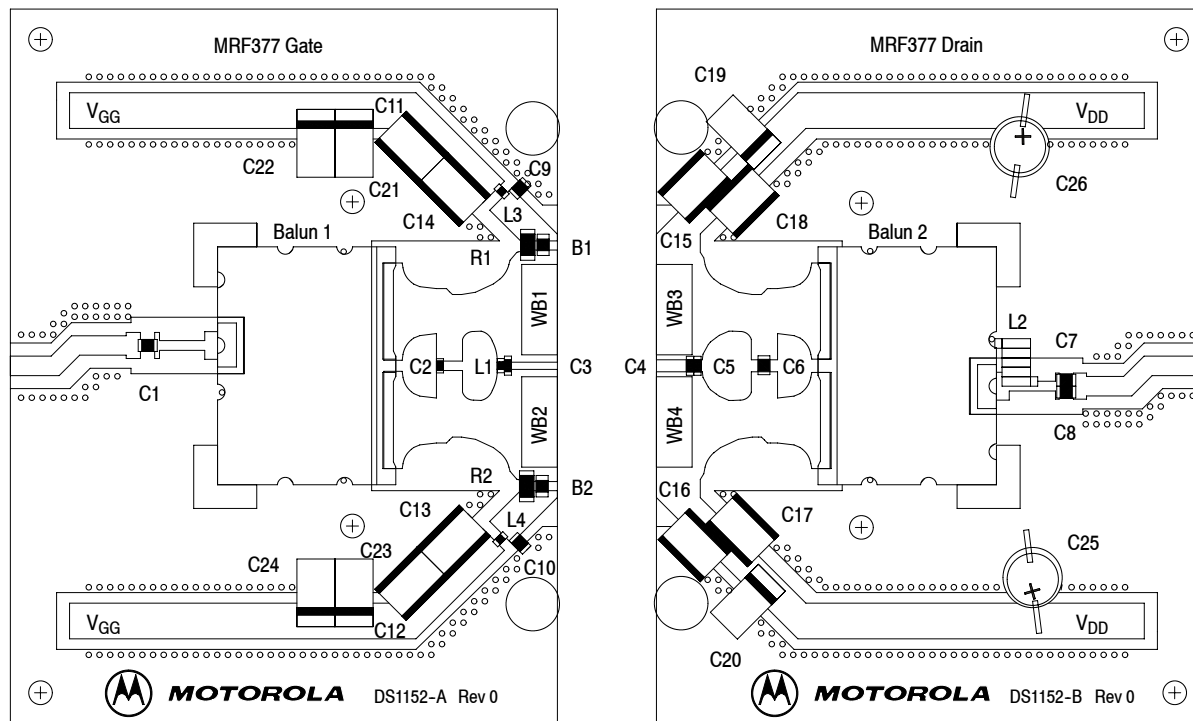
 LAST SHIP 30 JUN 12  
 LAST ORDER 1 JUL 11

**Table 5. 845-875 MHz Narrowband Test Circuit Component Designations and Values**

Part	Description	Part Number	Manufacturer
B1, B2	Ferrite Beads, Surface Mount, 11 $\Omega$ (0805)	2508051107Y0	Fair-Rite
Balun 1, Balun 2	0.8-1GHz Xinger Balun	3A412	Anaran
C1	33 pF Chip Capacitor (0805)	08055J330JBS	AVX
C2	2.7 pF Chip Capacitor (0603)	06035J2R7BBS	AVX
C3	12 pF Chip Capacitor (0805)	08051J120GBS	AVX
C4, C5	6.8 pF Chip Capacitors (0805)	08051J6R8BBS	AVX
C6	2.7 pF Chip Capacitor (0805)	0805J2R7BBS	AVX
C7, C8, C9, C10	3.3 pF Chip Capacitors (0805)	08051J3R3BBS	AVX
C11, C12	2.2 $\mu$ F, 50 V Chip Capacitors	C1825C225J5RAC	Kemet
C13, C14, C15, C16	0.01 $\mu$ F, 100 V Chip Capacitors	C1825C103J1GAC	Kemet
C17, C18	0.56 $\mu$ F, 50 V Chip Capacitors	C1825C564J5RAC	Kemet
C19, C20	10 $\mu$ F, 50 V Tantalum Chip Capacitors	T491D106K050AT	Kemet
C21, C22, C23, C24	47 $\mu$ F, 16 V Tantalum Chip Capacitors	T491D476K016AT	Kemet
C25, C26	470 $\mu$ F, 63 V Electrolytic Capacitors	EMVY630GTR471MMH0S	Nippon Chemi-Con
L1	12 nH Inductor (0603)	0603HC-12NXJB	CoilCraft
L2	7.15 nH Inductor	1606-7	CoilCraft
L3, L4	10 nH Inductors (0603)	0603HC-10NXJB	CoilCraft
R1, R2	24 $\Omega$ , 1/4 W, Chip Resistors	CRCW120624R0FKEA	Vishay

LIFETIME BUY

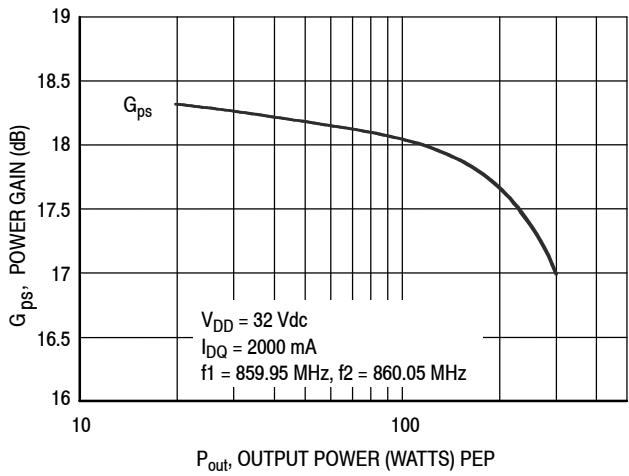
LAST ORDER 1 JUL 11 LAST SHIP 30 JUN 12



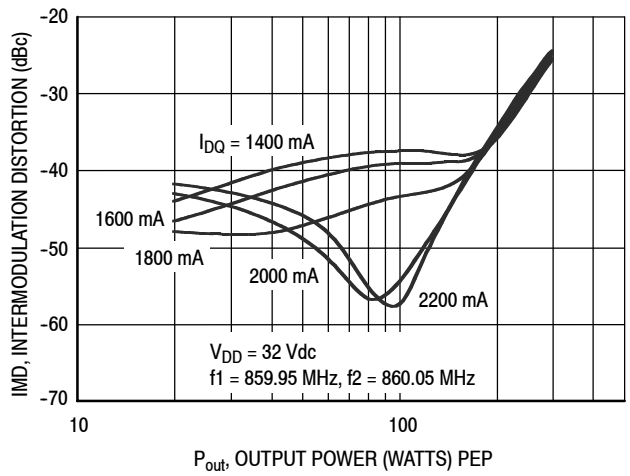
Freescale has begun the transition of marking Printed Circuit Boards (PCBs) with the Freescale Semiconductor signature/logo. PCBs may have either Motorola or Freescale markings during the transition period. These changes will have no impact on form, fit or function of the current product.

**Figure 1. 845-875 MHz Narrowband Test Circuit Component Layout**

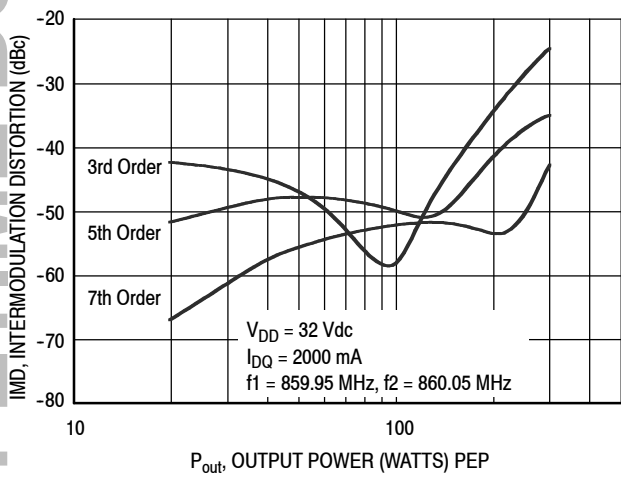
### TYPICAL NARROWBAND CHARACTERISTICS



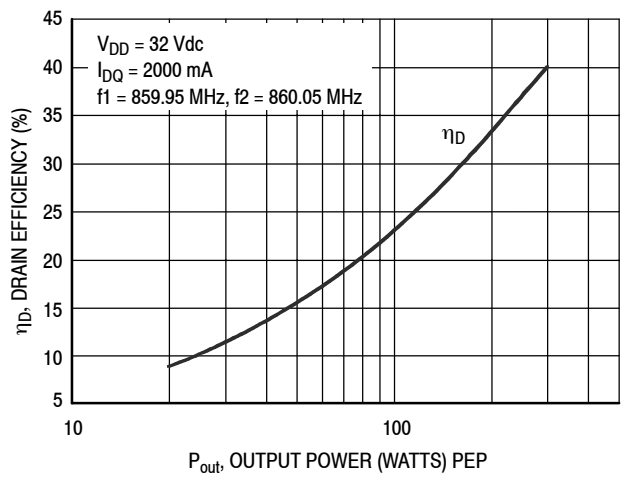
**Figure 2. Two-Tone Power Gain versus Output Power**



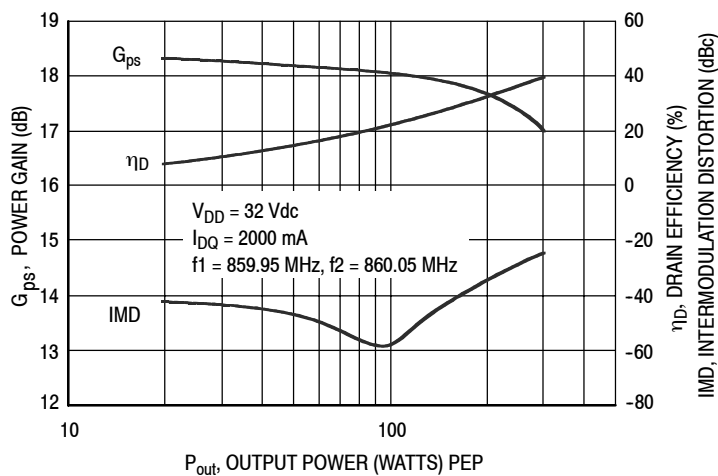
**Figure 3. Third Order Intermodulation Distortion versus Output Power**



**Figure 4. Intermodulation Distortion Products versus Output Power**



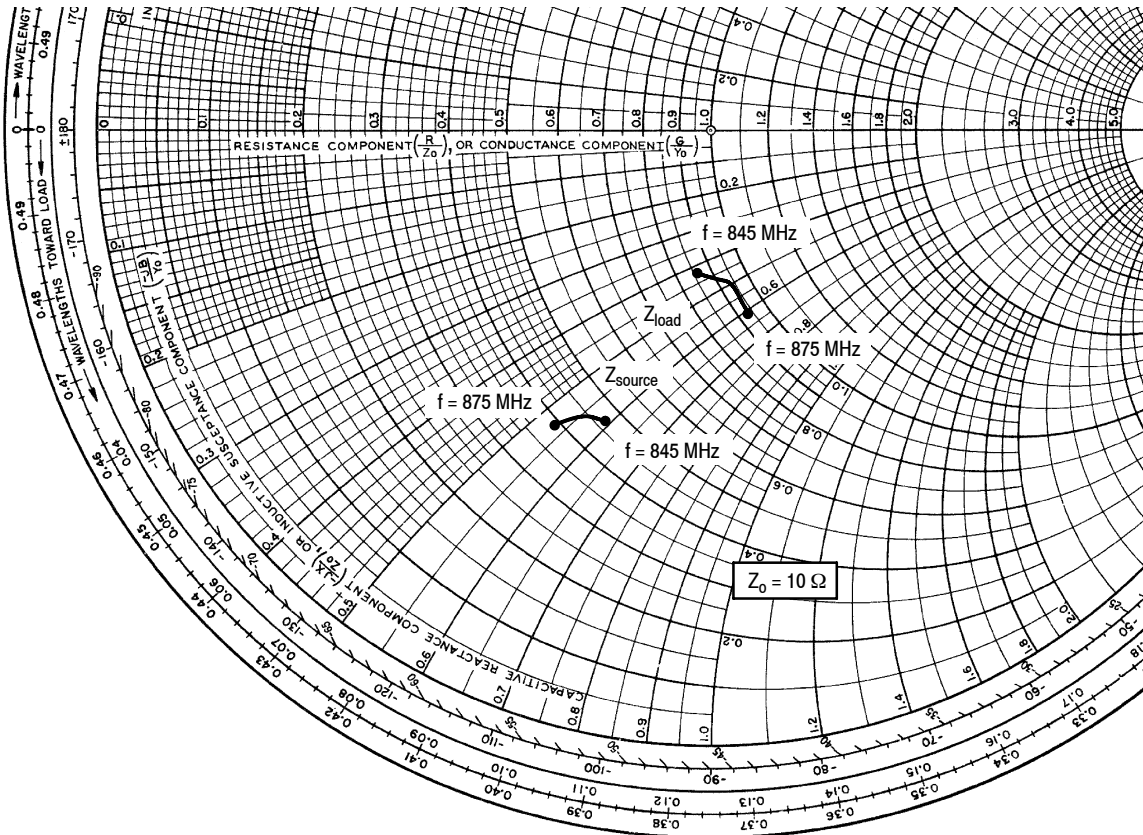
**Figure 5. Two-Tone Drain Efficiency versus Output Power**



**Figure 6. Power Gain, Efficiency and IMD versus Output Power**

LIFETIME BUY

LAST ORDER 1 JUL 11 LAST SHIP 30 JUN 12



$V_{DD} = 32\text{ V}$ ,  $I_{DQ} = 2000\text{ mA}$ ,  $P_{out} = 45\text{ W Avg.}$ , DVBT OFDM

f MHz	$Z_{source}$ $\Omega$	$Z_{load}$ $\Omega$
845	$4.66 - j5.90$	$8.59 - j4.22$
860	$4.38 - j5.64$	$9.36 - j4.95$
875	$3.93 - j5.33$	$9.39 - j6.06$

$Z_{source}$  = Test circuit impedance as measured from gate to gate, balanced configuration.

$Z_{load}$  = Test circuit impedance as measured from drain to drain, balanced configuration.

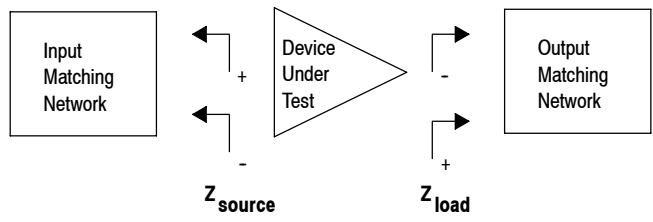


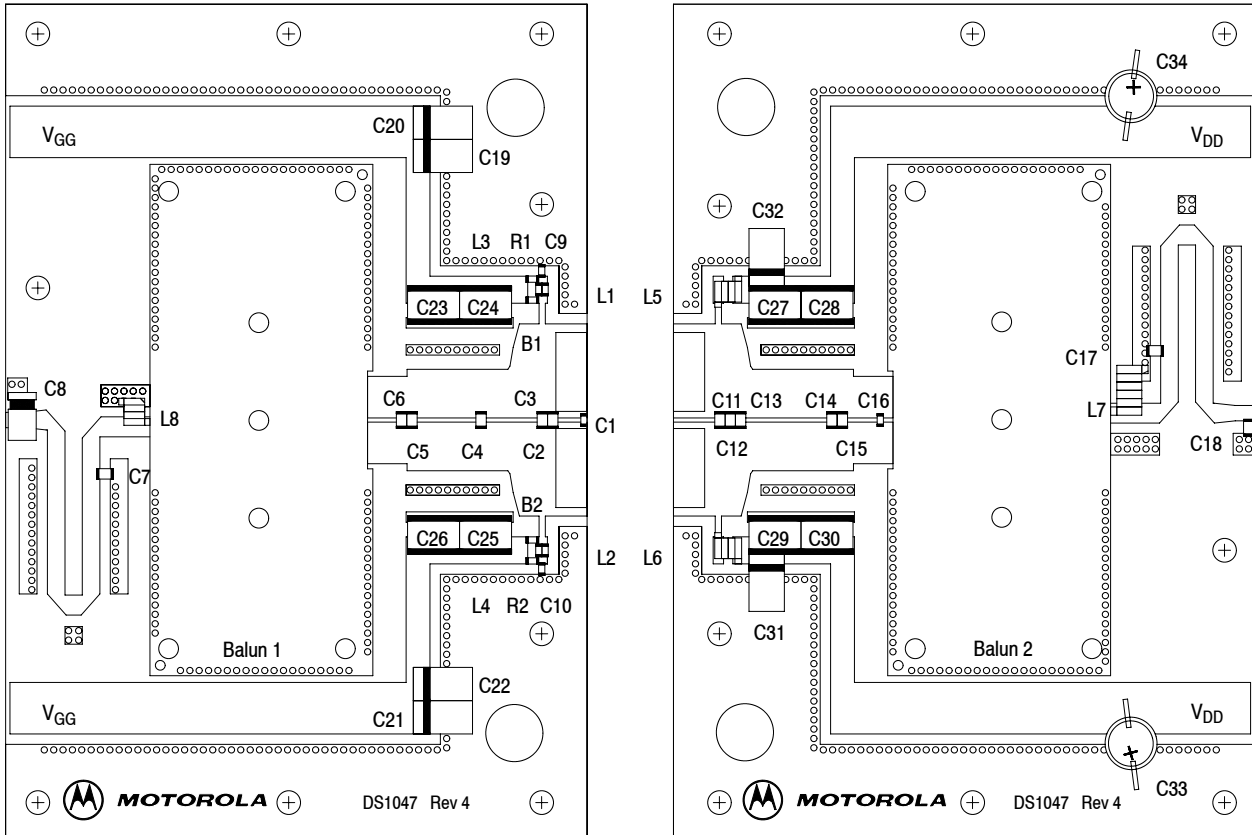
Figure 7. 845-875 MHz Narrowband Series Equivalent Source and Load Impedance

**Table 6. 470—860 MHz Broadband Test Circuit Component Designations and Values**

Part	Description	Part Number	Manufacturer
B1, B2	Ferrite Beads, Surface Mount, 30 $\Omega$ (0603)	2506033007Y0	Fair-Rite
Balun 1, Balun 2	Rogers 3.006, $\epsilon_r = 6.06$ , 1 oz Cu		
C1	12 pF Chip Capacitor (0603)	06035J120GBS	AVX
C2, C5	12 pF Chip Capacitors (0805)	08051J120GBS	AVX
C3	3.9 pF Chip Capacitor (0805)	08051J3R9BBS	AVX
C4, C7, C12, C15, C17	8.2 pF Chip Capacitors (0805)	08051J8R2BBS	AVX
C6	3.3 pF Chip Capacitor (0805)	08051J3R3BBS	AVX
C8	0.4–2.5 pF Variable Capacitor	27283PC	Gigatronics
C9, C10	3.3 pF Chip Capacitors (0603)	06035J3R3BBS	AVX
C11, C14	10 pF Chip Capacitors (0805)	08051J100GBS	AVX
C13	4.7 pF Chip Capacitor (0805)	08051J4R7BBS	AVX
C16	2.2 pF Chip Capacitor (0603)	06035J2R2BBS	AVX
C18	2.2 pF Chip Capacitor (0805)	08051J2R2BBS	AVX
C19, C20, C21, C22	47 $\mu$ F, 16 V Tantalum Chip Capacitors	T491D476K016AT	Kemet
C23, C26	2.2 $\mu$ F, 50 V Ceramic Chip Capacitors	C1825C225J5RAC	Kemet
C24, C25, C27, C29	0.01 $\mu$ F, 100 V Ceramic Chip Capacitors	C1825C103J1GAC	Kemet
C28, C30	0.56 $\mu$ F, 50 V Ceramic Chip Capacitors	C1825C564J5GAC	Kemet
C31, C32	10 $\mu$ F, 50 V Chip Capacitors	T491D106K010AT	Kemet
C33, C34	470 $\mu$ F, 63 V Electrolytic Capacitors	EMVY630GTR471MMH0S	United Chemi-Con
L1, L2	15 nH Inductors (0603)	L0603150GGW003	AVX
L3, L4	12 nH Inductors (0603)	0603HC-12NHJBU	CoilCraft
L5, L6	8 nH Coil Inductors	A03T-5	CoilCraft
L7	22 nH Coil Inductor	B07T-5	CoilCraft
L8	18.5 nH Coil Inductor	A05T-5	CoilCraft
R1, R2	12.1 $\Omega$ , 1/16 W, Chip Resistors	CRCW060312R1FKEA	Vishay

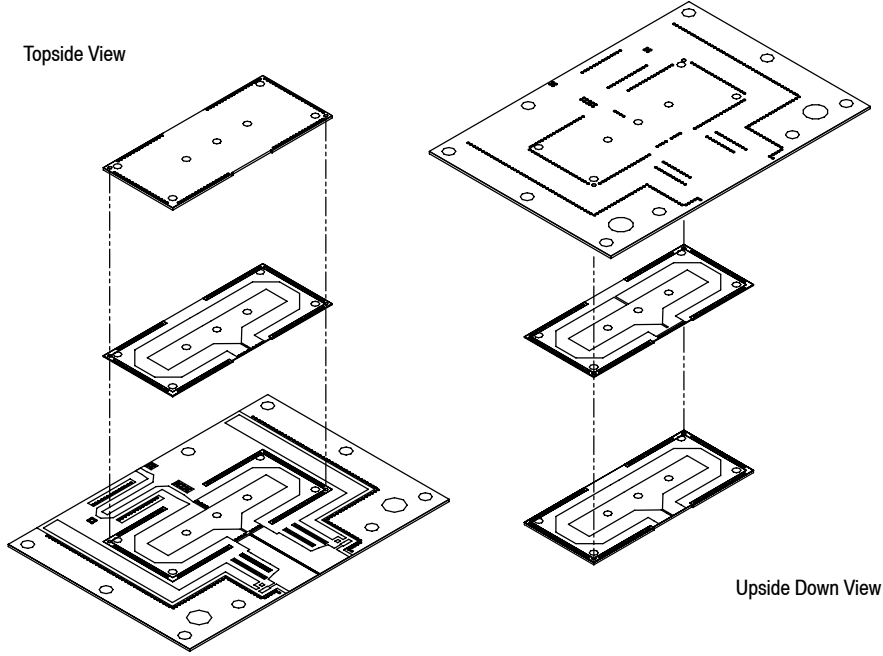
LIFETIME BUY

LAST ORDER 1 JUL 11 LAST SHIP 30 JUN 12



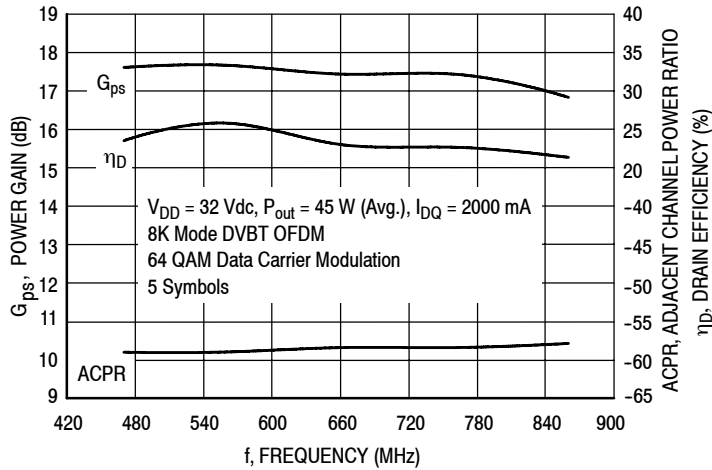
Freescale has begun the transition of marking Printed Circuit Boards (PCBs) with the Freescale Semiconductor signature/logo. PCBs may have either Motorola or Freescale markings during the transition period. These changes will have no impact on form, fit or function of the current product.

**Multilayer Balun Mounting Detail**

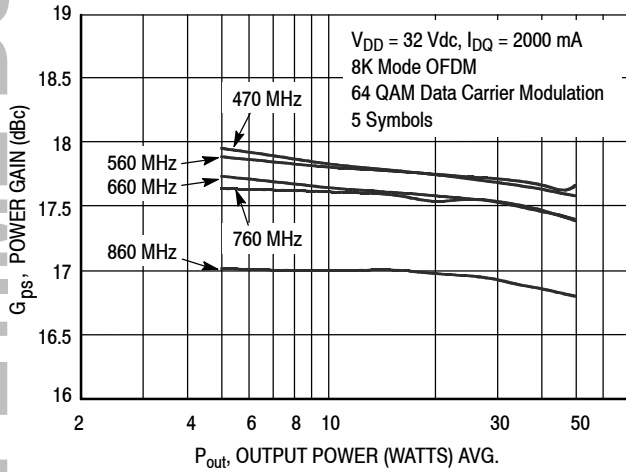


**Figure 8. 470-860 MHz Broadband Test Circuit Component Layout**

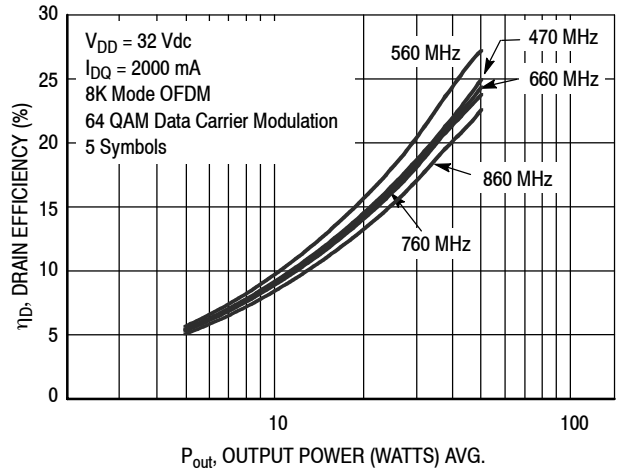
## TYPICAL DVBT OFDM BROADBAND CHARACTERISTICS



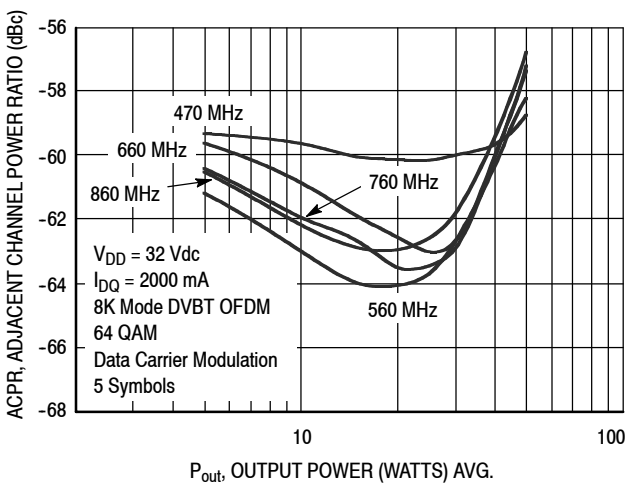
**Figure 9. Single-Channel DVBT OFDM Broadband Performance**



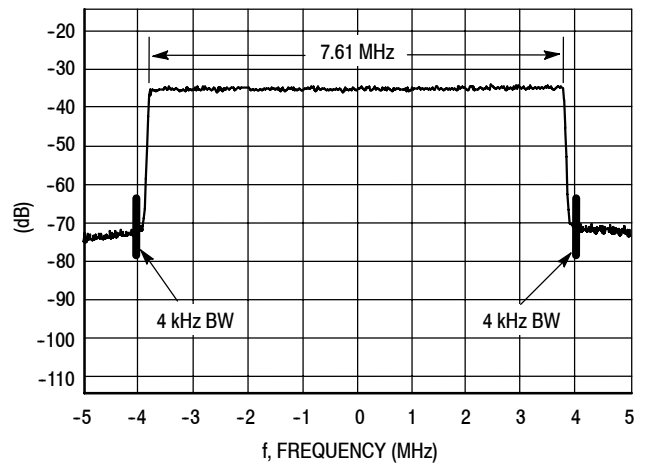
**Figure 10. Single-Channel DVBT OFDM Broadband Performance Power Gain versus Output Power**



**Figure 11. Single-Channel DVBT OFDM Broadband Performance Drain Efficiency versus Output Power**



**Figure 12. Single-Channel DVBT OFDM Broadband Performance Adjacent Channel Power Ratio versus Output Power**

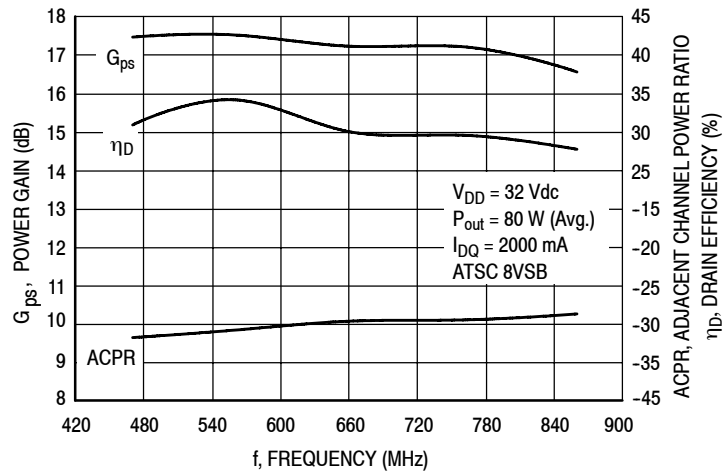


**Figure 13. 8K Mode DVBT OFDM Spectrum**

LIFETIME BUY

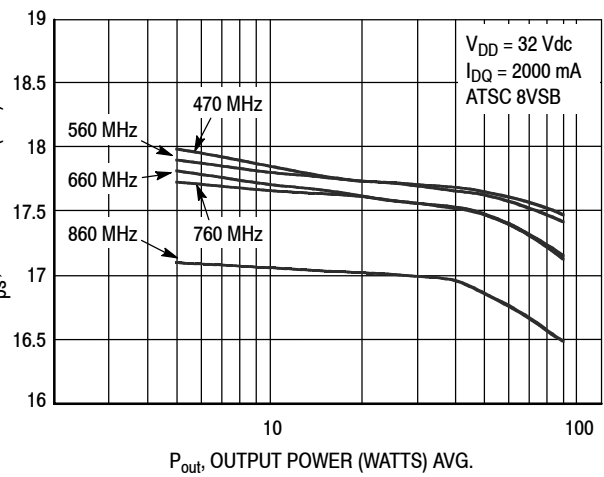
LAST ORDER 1 JUL 11 LAST SHIP 30 JUN 12

### TYPICAL ATSC 8VSB BROADBAND CHARACTERISTICS

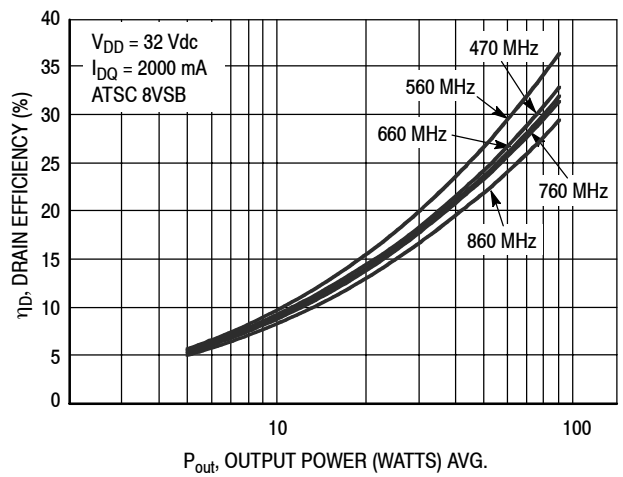


**Figure 14. Single-Channel ATSC 8VSB Broadband Performance**

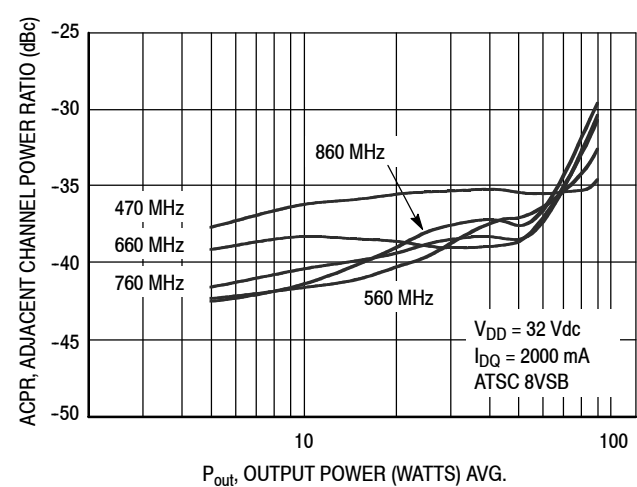
LIFETIME BUY



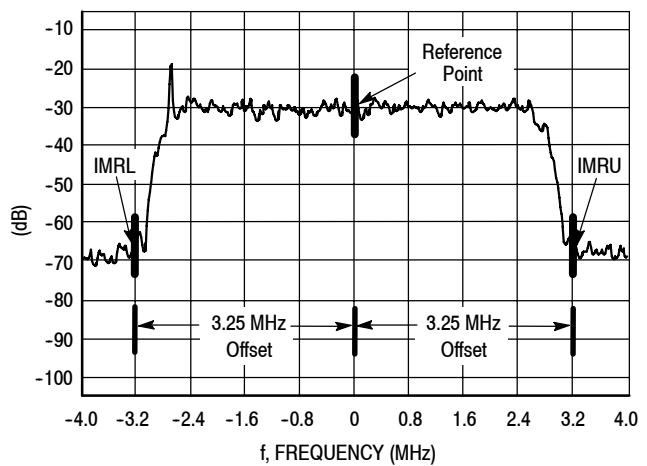
**Figure 15. Single-Channel ATSC 8VSB Broadband Performance Power Gain versus Output Power**



**Figure 16. Single-Channel ATSC 8VSB Broadband Performance Drain Efficiency versus Output Power**

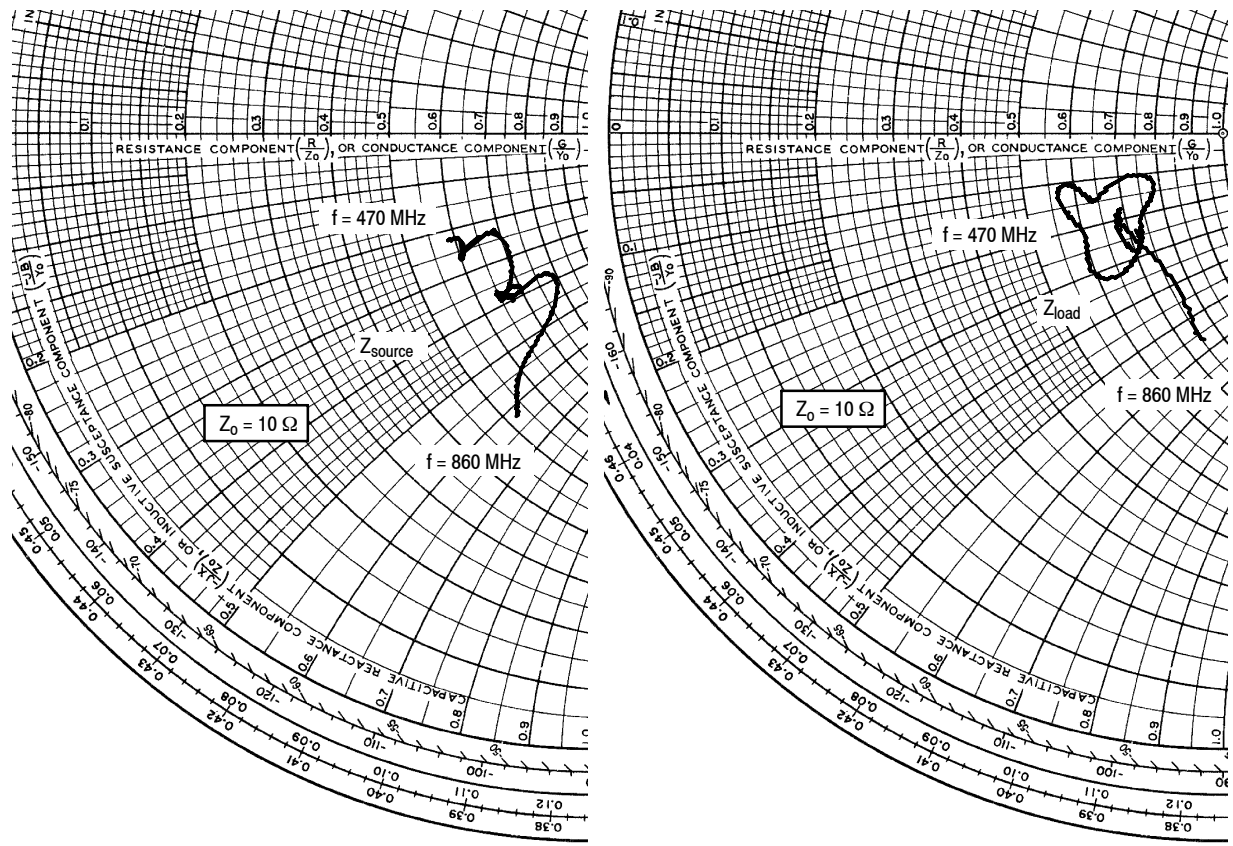


**Figure 17. Single-Channel ATSC 8VSB Broadband Performance Adjacent Channel Power Ratio versus Output Power**



**Figure 18. ATSC 8VSB Spectrum**

LAST ORDER 1 JUL 11 LAST SHIP 30 JUN 12



Optimized for  $V_{DD} = 32\text{ V}$ ,  $I_{DQ} = 2000\text{ mA}$ ,  $P_{out} = 45\text{ W Avg.}$ , DVBT OFDM

f MHz	$Z_{source}$ $\Omega$	$Z_{load}$ $\Omega$
470	5.79 - j2.40	6.21 - j1.69
560	6.63 - j2.63	5.66 - j1.12
660	6.57 - j4.03	6.76 - j1.00
760	6.67 - j4.55	6.57 - j1.91
860	5.34 - j6.28	7.37 - j5.45

$Z_{source}$  = Test circuit impedance as measured from gate to gate, balanced configuration.

$Z_{load}$  = Test circuit impedance as measured from drain to drain, balanced configuration.

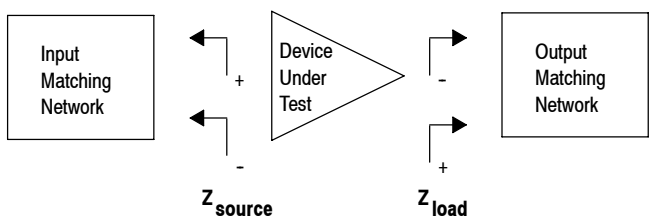
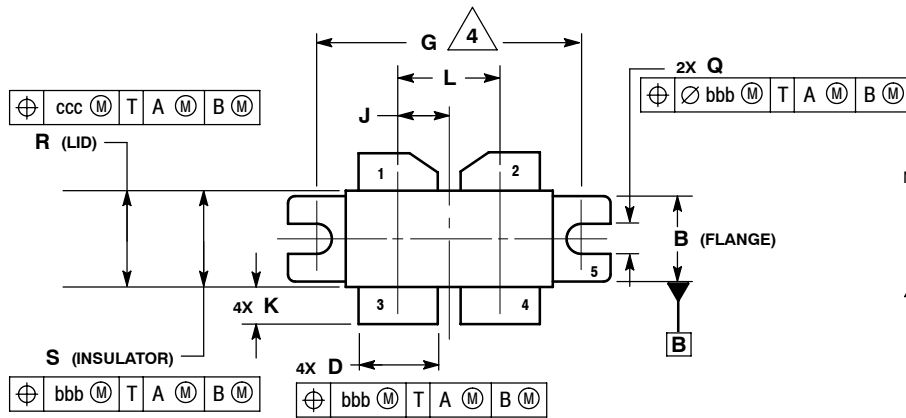


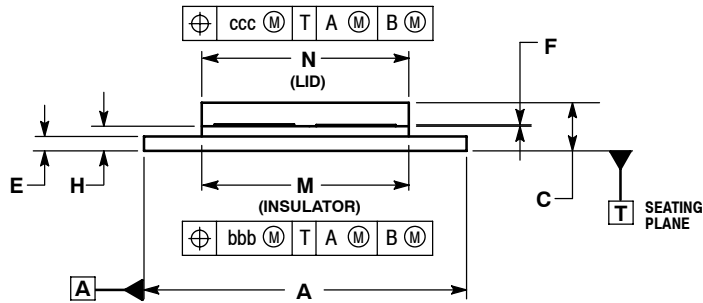
Figure 19. 470—860 MHz Broadband Series Equivalent Source and Load Impedance

### PACKAGE DIMENSIONS



- NOTES:
1. CONTROLLING DIMENSION: INCH.
  2. INTERPRET DIMENSIONS AND TOLERANCES PER ASME Y14.5M-1994.
  3. DIMENSION H TO BE MEASURED 0.030 (0.762) AWAY FROM PACKAGE BODY.
  4. RECOMMENDED BOLT CENTER DIMENSION OF 1.140 (28.96) BASED ON 3M SCREW.

DIM	INCHES		MILLIMETERS	
	MIN	MAX	MIN	MAX
A	1.335	1.345	33.91	34.16
B	0.380	0.390	9.65	9.91
C	0.180	0.224	4.57	5.69
D	0.325	0.335	8.26	8.51
E	0.060	0.070	1.52	1.78
F	0.004	0.006	0.10	0.15
G	1.100 BSC		27.94 BSC	
H	0.097	0.107	2.46	2.72
J	0.2125 BSC		5.397 BSC	
K	0.135	0.165	3.43	4.19
L	0.425 BSC		10.8 BSC	
M	0.852	0.868	21.64	22.05
N	0.851	0.869	21.62	22.07
Q	0.118	0.138	3.00	3.30
R	0.395	0.405	10.03	10.29
S	0.394	0.406	10.01	10.31
bbb	0.010 REF		0.25 REF	
ccc	0.015 REF		0.38 REF	



- STYLE 1:  
 PIN 1: DRAIN  
 2: DRAIN  
 3: GATE  
 4: GATE  
 5: SOURCE

**CASE 375G-04  
 ISSUE G  
 NI-860C3**

## PRODUCT DOCUMENTATION

Refer to the following documents to aid your design process.

### Application Notes

- AN1955: Thermal Measurement Methodology of RF Power Amplifiers

### Engineering Bulletins

- EB212: Using Data Sheet Impedances for RF LDMOS Devices

## REVISION HISTORY

The following table summarizes revisions to this document.

Revision	Date	Description
2	Mar. 2009	<ul style="list-style-type: none"> <li>• Data sheet revised to reflect part status change, removing MRF377HR5. Refer to PCN13170. (See Rev. 1 data sheet for MRF377HR5.)</li> <li>• Updated Part Numbers in Tables 5 and 6, Component Designations and Values, to RoHS compliant part numbers, p. 4, 7</li> <li>• Added Revision History, p. 13</li> </ul>

LIFETIME BUY

LAST ORDER 1 JUL 11 LAST SHIP 30 JUN 12

## How to Reach Us:

### Home Page:

[www.freescale.com](http://www.freescale.com)

### Web Support:

<http://www.freescale.com/support>

### USA/Europe or Locations Not Listed:

Freescale Semiconductor, Inc.  
 Technical Information Center, EL516  
 2100 East Elliot Road  
 Tempe, Arizona 85284  
 1-800-521-6274 or +1-480-768-2130  
[www.freescale.com/support](http://www.freescale.com/support)

### Europe, Middle East, and Africa:

Freescale Halbleiter Deutschland GmbH  
 Technical Information Center  
 Schatzbogen 7  
 81829 Muenchen, Germany  
 +44 1296 380 456 (English)  
 +46 8 52200080 (English)  
 +49 89 92103 559 (German)  
 +33 1 69 35 48 48 (French)  
[www.freescale.com/support](http://www.freescale.com/support)

### Japan:

Freescale Semiconductor Japan Ltd.  
 Headquarters  
 ARCO Tower 15F  
 1-8-1, Shimo-Meguro, Meguro-ku,  
 Tokyo 153-0064  
 Japan  
 0120 191014 or +81 3 5437 9125  
[support.japan@freescale.com](mailto:support.japan@freescale.com)

### Asia/Pacific:

Freescale Semiconductor China Ltd.  
 Exchange Building 23F  
 No. 118 Jianguo Road  
 Chaoyang District  
 Beijing 100022  
 China  
 +86 10 5879 8000  
[support.asia@freescale.com](mailto:support.asia@freescale.com)

### For Literature Requests Only:

Freescale Semiconductor Literature Distribution Center  
 P.O. Box 5405  
 Denver, Colorado 80217  
 1-800-441-2447 or +1-303-675-2140  
 Fax: +1-303-675-2150  
[LDCForFreescaleSemiconductor@hibbertgroup.com](mailto:LDCForFreescaleSemiconductor@hibbertgroup.com)

Information in this document is provided solely to enable system and software implementers to use Freescale Semiconductor products. There are no express or implied copyright licenses granted hereunder to design or fabricate any integrated circuits or integrated circuits based on the information in this document.

Freescale Semiconductor reserves the right to make changes without further notice to any products herein. Freescale Semiconductor makes no warranty, representation or guarantee regarding the suitability of its products for any particular purpose, nor does Freescale Semiconductor assume any liability arising out of the application or use of any product or circuit, and specifically disclaims any and all liability, including without limitation consequential or incidental damages. "Typical" parameters that may be provided in Freescale Semiconductor data sheets and/or specifications can and do vary in different applications and actual performance may vary over time. All operating parameters, including "Typicals", must be validated for each customer application by customer's technical experts. Freescale Semiconductor does not convey any license under its patent rights nor the rights of others. Freescale Semiconductor products are not designed, intended, or authorized for use as components in systems intended for surgical implant into the body, or other applications intended to support or sustain life, or for any other application in which the failure of the Freescale Semiconductor product could create a situation where personal injury or death may occur. Should Buyer purchase or use Freescale Semiconductor products for any such unintended or unauthorized application, Buyer shall indemnify and hold Freescale Semiconductor and its officers, employees, subsidiaries, affiliates, and distributors harmless against all claims, costs, damages, and expenses, and reasonable attorney fees arising out of, directly or indirectly, any claim of personal injury or death associated with such unintended or unauthorized use, even if such claim alleges that Freescale Semiconductor was negligent regarding the design or manufacture of the part.

Freescale™ and the Freescale logo are trademarks of Freescale Semiconductor, Inc. All other product or service names are the property of their respective owners.

© Freescale Semiconductor, Inc. 2006, 2009. All rights reserved.