



Chipsmall Limited consists of a professional team with an average of over 10 year of expertise in the distribution of electronic components. Based in Hongkong, we have already established firm and mutual-benefit business relationships with customers from,Europe,America and south Asia,supplying obsolete and hard-to-find components to meet their specific needs.

With the principle of "Quality Parts,Customers Priority,Honest Operation,and Considerate Service",our business mainly focus on the distribution of electronic components. Line cards we deal with include Microchip,ALPS,ROHM,Xilinx,Pulse,ON,Everlight and Freescale. Main products comprise IC,Modules,Potentiometer,IC Socket,Relay,Connector.Our parts cover such applications as commercial,industrial, and automotives areas.

We are looking forward to setting up business relationship with you and hope to provide you with the best service and solution. Let us make a better world for our industry!



## Contact us

Tel: +86-755-8981 8866 Fax: +86-755-8427 6832

Email & Skype: info@chipsmall.com Web: www.chipsmall.com

Address: A1208, Overseas Decoration Building, #122 Zhenhua RD., Futian, Shenzhen, China



# RF Power Field Effect Transistors

## N-Channel Enhancement-Mode Lateral MOSFETs

Designed for W-CDMA and LTE base station applications with frequencies from 2110 to 2170 MHz. Can be used in Class AB and Class C for all typical cellular base station modulation formats.

- Typical Single-Carrier W-CDMA Performance:  $V_{DD} = 28$  Volts,  $I_{DQ} = 1400$  mA,  $P_{out} = 48$  Watts Avg., IQ Magnitude Clipping, Channel Bandwidth = 3.84 MHz, Input Signal PAR = 7.5 dB @ 0.01% Probability on CCDF.

Frequency	$G_{ps}$ (dB)	$\eta_D$ (%)	Output PAR (dB)	ACPR (dBc)
2110 MHz	17.8	32.6	6.4	-37.7
2140 MHz	18.1	32.6	6.3	-37.1
2170 MHz	18.1	32.9	6.2	-36.2

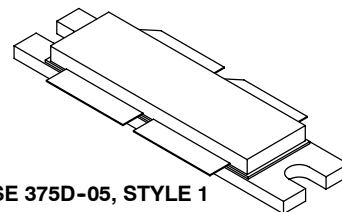
- Capable of Handling 10:1 VSWR, @ 32 Vdc, 2140 MHz, 250 Watts CW Output Power (3 dB Input Overdrive from Rated  $P_{out}$ )

### Features

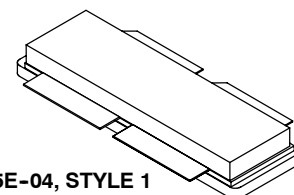
- 100% PAR Tested for Guaranteed Output Power Capability
- Characterized with Series Equivalent Large-Signal Impedance Parameters and Common Source S-Parameters
- Internally Matched for Ease of Use
- Integrated ESD Protection
- Greater Negative Gate-Source Voltage Range for Improved Class C Operation
- Designed for Digital Predistortion Error Correction Systems
- RoHS Compliant
- In Tape and Reel. R6 Suffix = 150 Units per 56 mm, 13 inch Reel.

**MRF8S21200HR6**  
**MRF8S21200HSR6**

**2110-2170 MHz, 48 W AVG., 28 V**  
**W-CDMA, LTE**  
**LATERAL N-CHANNEL**  
**RF POWER MOSFETs**



**CASE 375D-05, STYLE 1**  
**NI-1230**  
**MRF8S21200HR6**



**CASE 375E-04, STYLE 1**  
**NI-1230S**  
**MRF8S21200HSR6**

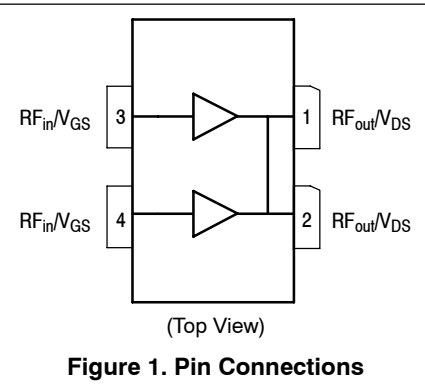
**Table 1. Maximum Ratings**

Rating	Symbol	Value	Unit
Drain-Source Voltage	$V_{DSS}$	-0.5, +65	Vdc
Gate-Source Voltage	$V_{GS}$	-6.0, +10	Vdc
Operating Voltage	$V_{DD}$	32, +0	Vdc
Storage Temperature Range	$T_{stg}$	-65 to +150	°C
Case Operating Temperature	$T_C$	150	°C
Operating Junction Temperature (1,2)	$T_J$	225	°C
CW Operation @ $T_A = 25^\circ\text{C}$ Derate above 25°C	CW	200 1.6	W W/°C

**Table 2. Thermal Characteristics**

Characteristic	Symbol	Value (2,3)	Unit
Thermal Resistance, Junction to Case Case Temperature 76°C, 48 W CW, 28 Vdc, $I_{DQ} = 1400$ mA Case Temperature 81°C, 200 W CW, 28 Vdc, $I_{DQ} = 1400$ mA	$R_{\theta JC}$	0.31 0.27	°C/W

1. Continuous use at maximum temperature will affect MTTF.
2. MTTF calculator available at <http://www.freescale.com/rf>. Select Software & Tools/Development Tools/Calculators to access MTTF calculators by product.
3. Refer to AN1955, *Thermal Measurement Methodology of RF Power Amplifiers*. Go to <http://www.freescale.com/rf>. Select Documentation/Application Notes - AN1955.



**Table 3. ESD Protection Characteristics**

Test Methodology	Class
Human Body Model (per JESD22-A114)	2 (Minimum)
Machine Model (per EIA/JESD22-A115)	A (Minimum)
Charge Device Model (per JESD22-C101)	IV (Minimum)

**Table 4. Electrical Characteristics** ( $T_A = 25^\circ\text{C}$  unless otherwise noted)

Characteristic	Symbol	Min	Typ	Max	Unit
----------------	--------	-----	-----	-----	------

**Off Characteristics**

Zero Gate Voltage Drain Leakage Current ( $V_{DS} = 65\text{ Vdc}$ , $V_{GS} = 0\text{ Vdc}$ )	$I_{DSS}$	—	—	10	$\mu\text{Adc}$
Zero Gate Voltage Drain Leakage Current ( $V_{DS} = 28\text{ Vdc}$ , $V_{GS} = 0\text{ Vdc}$ )	$I_{DSS}$	—	—	1	$\mu\text{Adc}$
Gate-Source Leakage Current ( $V_{GS} = 5\text{ Vdc}$ , $V_{DS} = 0\text{ Vdc}$ )	$I_{GSS}$	—	—	1	$\mu\text{Adc}$

**On Characteristics**

Gate Threshold Voltage ( $V_{DS} = 10\text{ Vdc}$ , $I_D = 300\ \mu\text{Adc}$ )	$V_{GS(th)}$	1.2	2.0	2.7	Vdc
Gate Quiescent Voltage ( $V_{DD} = 28\text{ Vdc}$ , $I_D = 1400\text{ mA}$ , Measured in Functional Test)	$V_{GS(Q)}$	2.0	2.7	3.5	Vdc
Drain-Source On-Voltage ( $V_{GS} = 10\text{ Vdc}$ , $I_D = 3\text{ Adc}$ )	$V_{DS(on)}$	0.1	0.17	0.3	Vdc

**Functional Tests** <sup>(1)</sup> (In Freescale Test Fixture, 50 ohm system)  $V_{DD} = 28\text{ Vdc}$ ,  $I_{DQ} = 1400\text{ mA}$ ,  $P_{out} = 48\text{ W Avg.}$ ,  $f = 2140\text{ MHz}$ , Single-Carrier W-CDMA, IQ Magnitude Clipping, Input Signal PAR = 7.5 dB @ 0.01% Probability on CCDF. ACPR measured in 3.84 MHz Channel Bandwidth @  $\pm 5\text{ MHz}$  Offset.

Power Gain	$G_{ps}$	16.5	18.1	19.5	dB
Drain Efficiency	$\eta_D$	30.0	32.6	—	%
Output Peak-to-Average Ratio @ 0.01% Probability on CCDF	PAR	5.7	6.3	—	dB
Adjacent Channel Power Ratio	ACPR	—	-37.1	-35.0	dBc
Input Return Loss	IRL	—	-15	-7	dB

**Typical Broadband Performance** (In Freescale Test Fixture, 50 ohm system)  $V_{DD} = 28\text{ Vdc}$ ,  $I_{DQ} = 1400\text{ mA}$ ,  $P_{out} = 48\text{ W Avg.}$ , Single-Carrier W-CDMA, IQ Magnitude Clipping, Input Signal PAR = 7.5 dB @ 0.01% Probability on CCDF. ACPR measured in 3.84 MHz Channel Bandwidth @  $\pm 5\text{ MHz}$  Offset.

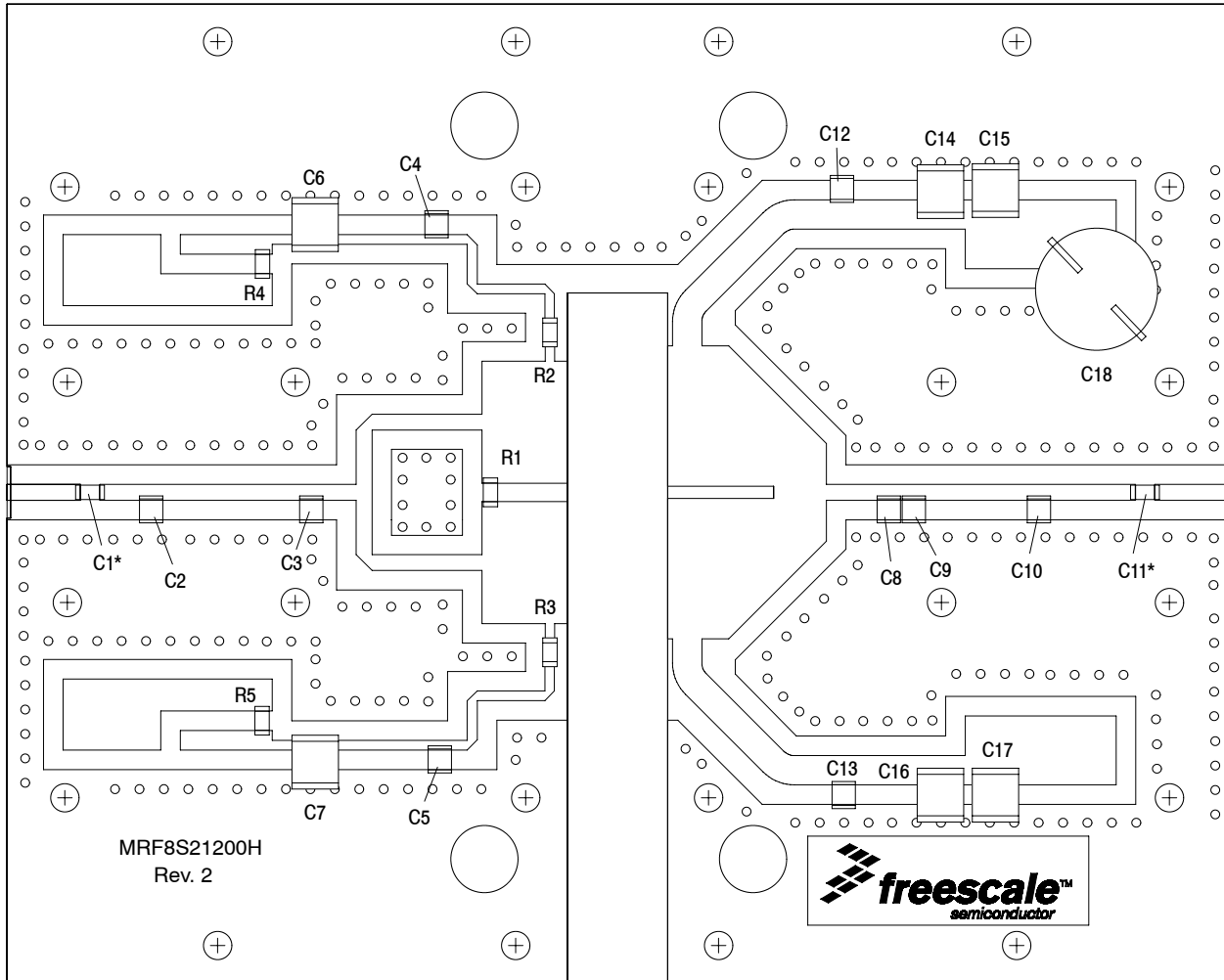
Frequency	$G_{ps}$ (dB)	$\eta_D$ (%)	Output PAR (dB)	ACPR (dBc)	IRL (dB)
2110 MHz	17.8	32.6	6.4	-37.7	-15
2140 MHz	18.1	32.6	6.3	-37.1	-15
2170 MHz	18.1	32.9	6.2	-36.2	-13

1. Part internally matched both on input and output.

(continued)

**Table 4. Electrical Characteristics** ( $T_A = 25^\circ\text{C}$  unless otherwise noted) **(continued)**

Characteristic	Symbol	Min	Typ	Max	Unit
<b>Typical Performances</b> (In Freescale Test Fixture, 50 ohm system) $V_{DD} = 28\text{ Vdc}$ , $I_{DQ} = 1400\text{ mA}$ , 2110–2170 MHz Bandwidth					
IMD Symmetry @ 140 W PEP, $P_{out}$ where IMD Third Order Intermodulation $\cong 30\text{ dBc}$ (Delta IMD Third Order Intermodulation between Upper and Lower Sidebands $> 2\text{ dB}$ )	$IMD_{sym}$	—	8	—	MHz
VBW Resonance Point (IMD Third Order Intermodulation Inflection Point)	$VBW_{res}$	—	35	—	MHz
Gain Flatness in 60 MHz Bandwidth @ $P_{out} = 48\text{ W Avg.}$	$G_F$	—	0.4	—	dB
Gain Variation over Temperature ( $-30^\circ\text{C}$ to $+85^\circ\text{C}$ )	$\Delta G$	—	0.02	—	dB/ $^\circ\text{C}$
Output Power Variation over Temperature ( $-30^\circ\text{C}$ to $+85^\circ\text{C}$ )	$\Delta P_{1dB}$	—	0.02	—	dB/ $^\circ\text{C}$



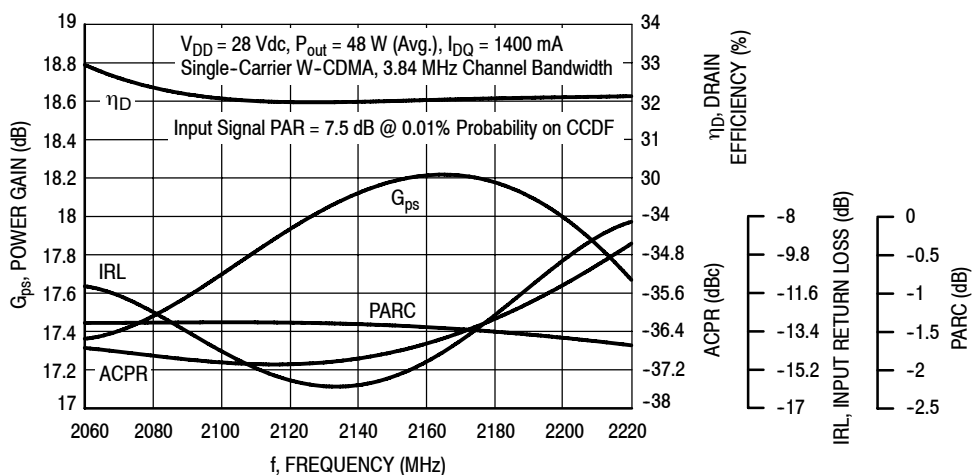
\*C1 and C11 are mounted vertically.

**Figure 2. MRF8S21200HR6(HSR6) Test Circuit Component Layout**

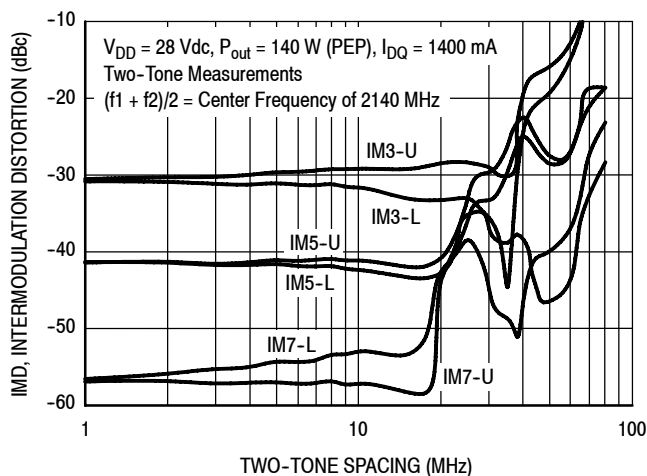
**Table 5. MRF8S21200HR6(HSR6) Test Circuit Component Designations and Values**

Part	Description	Part Number	Manufacturer
C1, C4, C5, C11, C12, C13	8.2 pF Chip Capacitors	ATC100B8R2CT500XT	ATC
C2	0.2 pF Chip Capacitor	ATC100B0R2BT500XT	ATC
C3	0.6 pF Chip Capacitor	ATC100B0R6BT500XT	ATC
C6, C7, C14, C15, C16, C17	10 $\mu$ F, 50 V Chip Capacitors	C5750X5R1H106MT	TDK
C8	0.5 pF Chip Capacitor	ATC100B0R5BT500XT	ATC
C9	0.8 pF Chip Capacitor	ATC100B0R8BT500XT	ATC
C10	0.3 pF Chip Capacitor	ATC100B0R3BT500XT	ATC
C18	470 $\mu$ F, 63 V Electrolytic Capacitor	MCGPR63V477M13X26-RH	Multicomp
R1	22 $\Omega$ , 1/4 W Chip Resistor	CRCW120622R0FKEA	Vishay
R2, R3	12 $\Omega$ , 1/4 W Chip Resistors	CRCW120612R0FKEA	Vishay
R4, R5	0 $\Omega$ , 3 A Chip Resistors	CRCW12060000Z0EA	Vishay
PCB	0.030", $\epsilon_r = 3.5$	RO4350B	Rogers

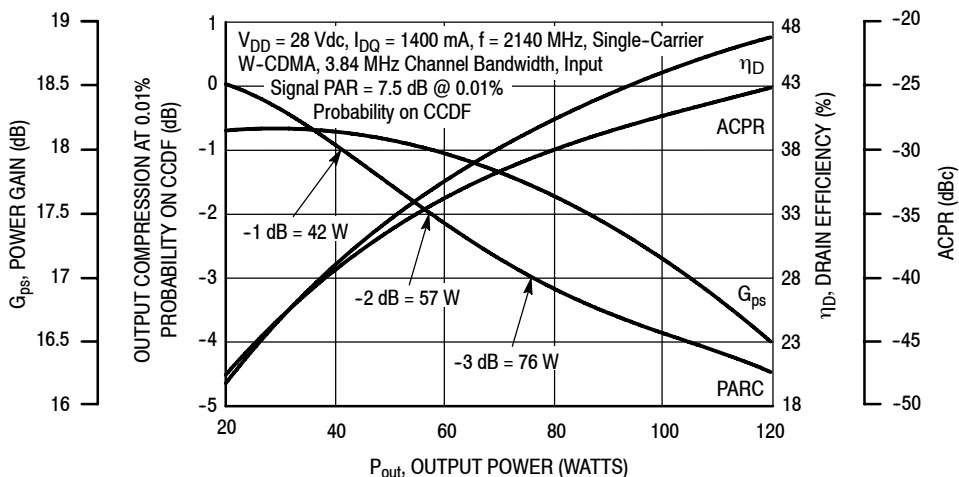
### TYPICAL CHARACTERISTICS



**Figure 3. Output Peak-to-Average Ratio Compression (PARC) Broadband Performance @  $P_{out} = 48$  Watts Avg.**

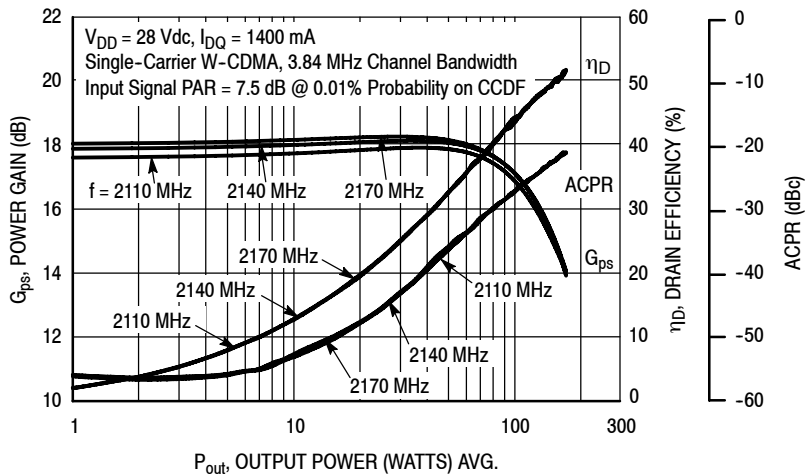


**Figure 4. Intermodulation Distortion Products versus Two-Tone Spacing**

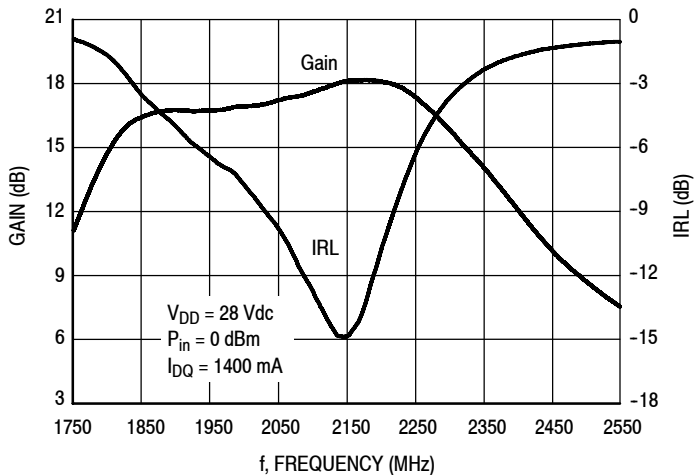


**Figure 5. Output Peak-to-Average Ratio Compression (PARC) versus Output Power**

### TYPICAL CHARACTERISTICS

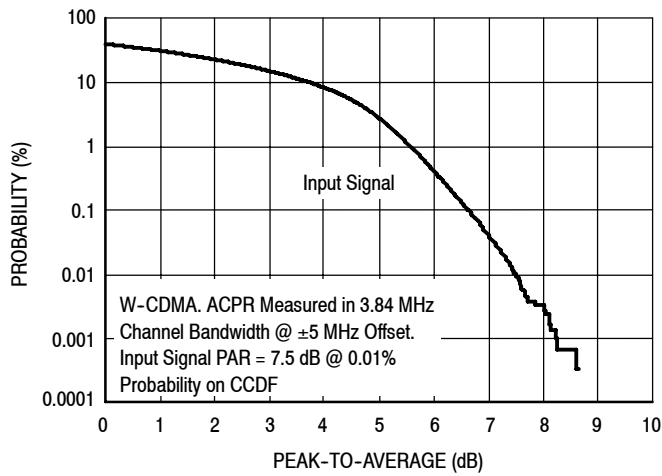


**Figure 6. Single-Carrier W-CDMA Power Gain, Drain Efficiency and ACPR versus Output Power**

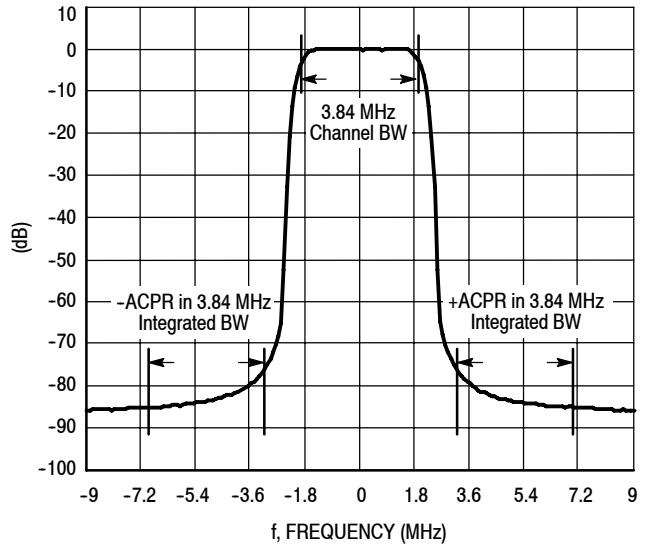


**Figure 7. Broadband Frequency Response**

### W-CDMA TEST SIGNAL



**Figure 8. CCDF W-CDMA IQ Magnitude Clipping, Single-Carrier Test Signal**



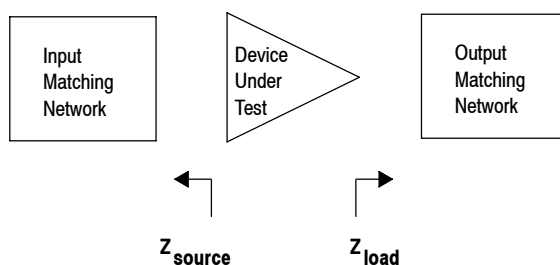
**Figure 9. Single-Carrier W-CDMA Spectrum**

$V_{DD} = 28 \text{ Vdc}$ ,  $I_{DQ} = 1400 \text{ mA}$ ,  $P_{out} = 48 \text{ W Avg.}$

f MHz	$Z_{source}$ $\Omega$	$Z_{load}$ $\Omega$
2060	3.64 - j4.51	1.42 - j2.27
2080	3.65 - j4.50	1.41 - j2.21
2100	3.64 - j4.53	1.40 - j2.15
2120	3.56 - j4.47	1.40 - j2.09
2140	3.58 - j4.44	1.39 - j2.03
2160	3.58 - j4.44	1.38 - j1.97
2180	3.57 - j4.44	1.38 - j1.91
2200	3.56 - j4.45	1.38 - j1.86
2220	3.54 - j4.64	1.37 - j1.80

$Z_{source}$  = Test circuit impedance as measured from gate to ground.

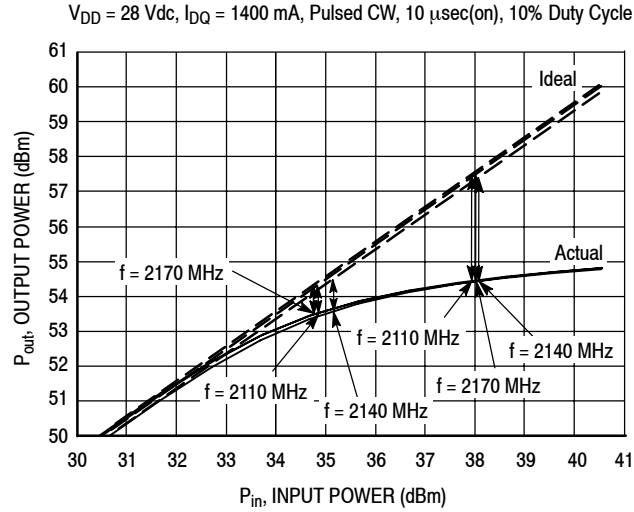
$Z_{load}$  = Test circuit impedance as measured from drain to ground.



**Figure 10. Series Equivalent Source and Load Impedance**



## ALTERNATIVE PEAK TUNE LOAD PULL CHARACTERISTICS



NOTE: Load Pull Test Fixture Tuned for Peak P1dB Output Power @ 28 V

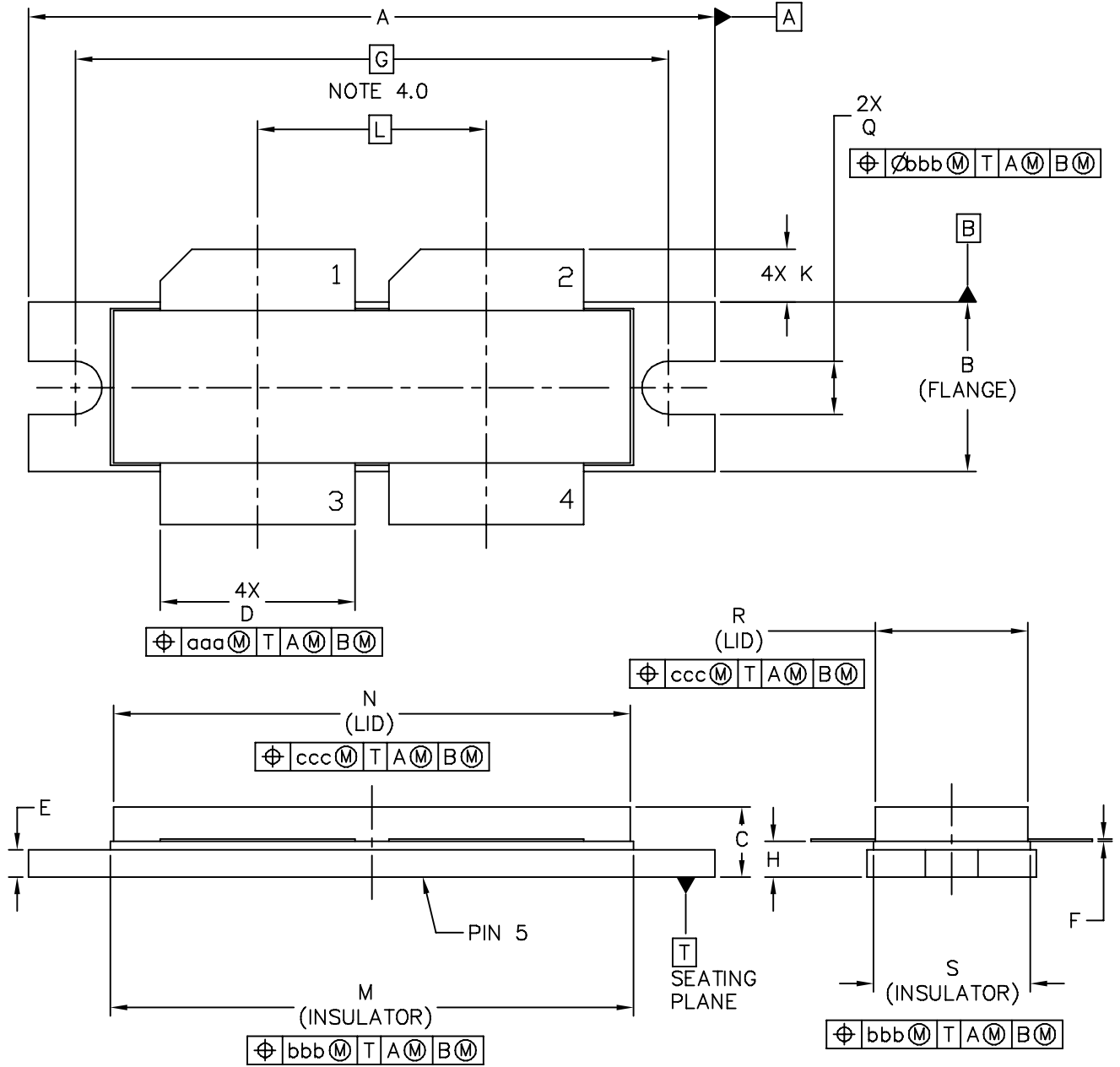
f (MHz)	P1dB		P3dB	
	Watts	dBm	Watts	dBm
2110	231	53.6	276	54.4
2140	230	53.6	279	54.5
2170	229	53.6	277	54.4

Test Impedances per Compression Level

f (MHz)		$Z_{\text{source}}$ $\Omega$	$Z_{\text{load}}$ $\Omega$
2110	P1dB	2.14 - j5.14	0.77 - j1.44
2140	P1dB	3.28 - j6.37	0.75 - j1.52
2170	P1dB	5.59 - j7.20	0.67 - j1.41

**Figure 11. Pulsed CW Output Power versus Input Power @ 28 V**

**PACKAGE DIMENSIONS**



© FREESCALE SEMICONDUCTOR, INC. ALL RIGHTS RESERVED.		<b>MECHANICAL OUTLINE</b>		PRINT VERSION NOT TO SCALE	
TITLE:  NI-1230		DOCUMENT NO: 98ASB16977C		REV: E	
		CASE NUMBER: 375D-05		31 MAR 2005	
		STANDARD: NON-JEDEC			

NOTES:

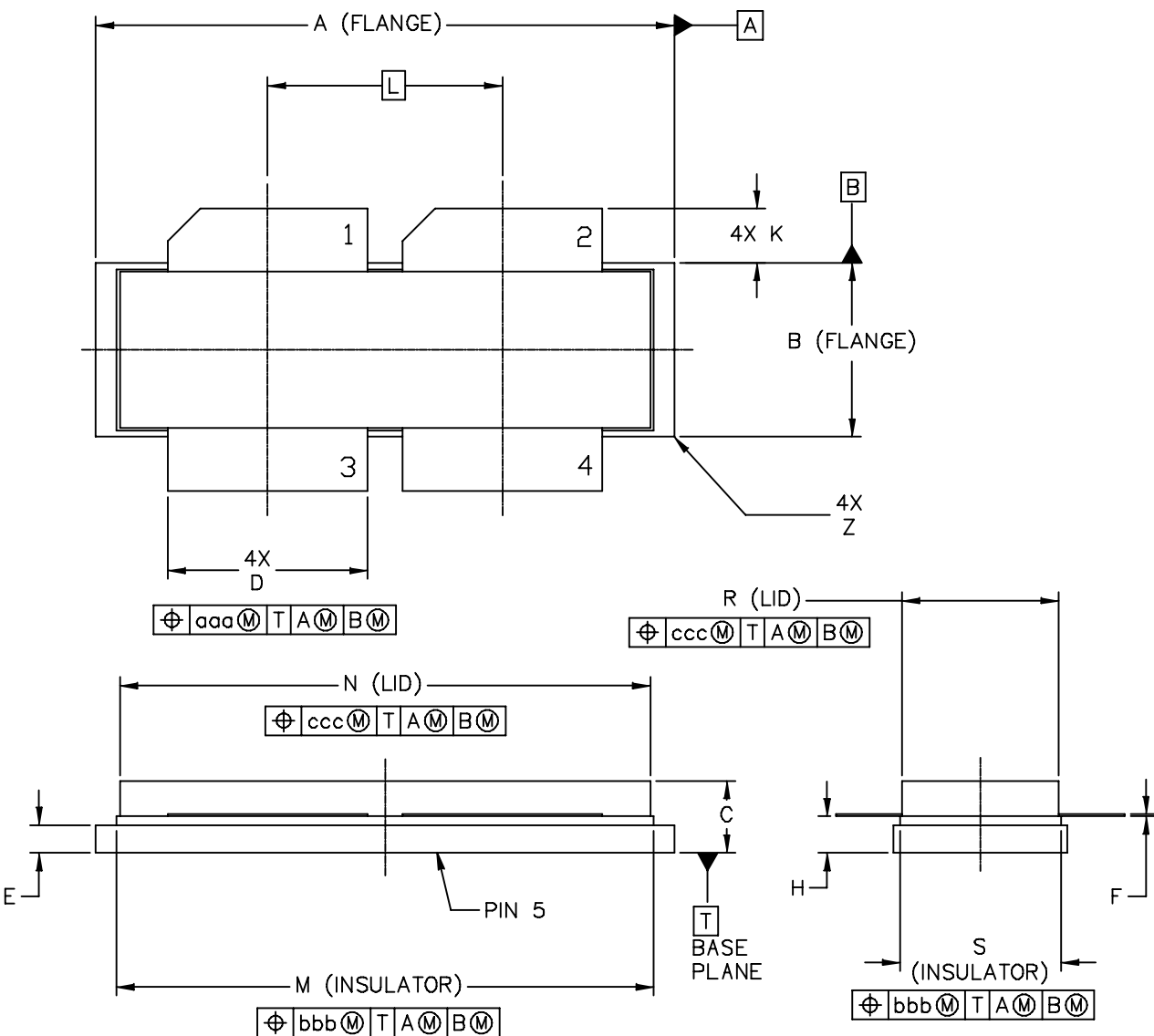
- 1.0 INTERPRET DIMENSIONS AND TOLERANCES PER ASME Y14.5M-1994.
- 2.0 CONTROLLING DIMENSION: INCH
- 3.0 DIMENSION H IS MEASURED .030 (0.762) AWAY FROM PACKAGE BODY.
- 4.0 RECOMMENDED BOLT CENTER DIMENSION OF 1.52 (38.61) BASED ON M3 SCREW.

STYLE 1:

- PIN 1 - DRAIN
- 2 - DRAIN
- 3 - GATE
- 4 - GATE
- 5 - SOURCE

DIM	INCH		MILLIMETER		DIM	INCH		MILLIMETER	
	MIN	MAX	MIN	MAX		MIN	MAX	MIN	MAX
A	1.615	1.625	41.02	41.28	N	1.218	1.242	30.94	31.55
B	.395	.405	10.03	10.29	Q	.120	.130	3.05	3.3
C	.150	.200	3.81	5.08	R	.355	.365	9.01	9.27
D	.455	.465	11.56	11.81	S	.365	.375	9.27	9.53
E	.062	.066	1.57	1.68					
F	.004	.007	0.1	0.18					
G	1.400 BSC		35.56 BSC		aaa	.013		0.33	
H	.082	.090	2.08	2.29	bbb	.010		0.25	
K	.117	.137	2.97	3.48	ccc	.020		0.51	
L	.540 BSC		13.72 BSC						
M	1.219	1.241	30.96	31.52					

© FREESCALE SEMICONDUCTOR, INC. ALL RIGHTS RESERVED.		<b>MECHANICAL OUTLINE</b>		PRINT VERSION NOT TO SCALE	
TITLE:  NI-1230		DOCUMENT NO: 98ASB16977C		REV: E	
		CASE NUMBER: 375D-05		31 MAR 2005	
		STANDARD: NON-JEDEC			



© FREESCALE SEMICONDUCTOR, INC. ALL RIGHTS RESERVED.		MECHANICAL OUTLINE		PRINT VERSION NOT TO SCALE	
TITLE:  NI-1230S		DOCUMENT NO: 98ARB18247C		REV: F	
		CASE NUMBER: 375E-04		05 AUG 2005	
		STANDARD: NON-JEDEC			

NOTES:

1. INTERPRET DIMENSIONS AND TOLERANCES PER ASME Y14.5M-1994.
2. CONTROLLING DIMENSION: INCH
3. DIMENSION H IS MEASURED .030 AWAY FROM PACKAGE BODY

STYLE 1:

- PIN 1 - DRAIN
- 2 - DRAIN
- 3 - GATE
- 4 - GATE
- 5 - SOURCE

DIM	INCHES		MILLIMETERS		DIM	INCHES		MILLIMETERS	
	MIN	MAX	MIN	MAX		MIN	MAX	MIN	MAX
A	1.265	1.275	32.13	32.38	R	.355	.365	9.01	9.27
B	.395	.405	10.03	10.29	S	.365	.375	9.27	9.53
C	.150	.200	3.81	5.08	Z	---	.040	---	1.02
D	.455	.465	11.56	11.81					
E	.062	.066	1.57	1.68	aaa	.013		0.33	
F	.004	.007	0.1	0.18	bbb	.010		0.25	
H	.082	.090	2.08	2.29	ccc	.020		0.51	
K	.117	.137	2.97	3.48					
L	.540 BSC		13.72 BSC						
M	1.219	1.241	30.96	31.52					
N	1.218	1.242	30.94	31.55					

© FREESCALE SEMICONDUCTOR, INC. ALL RIGHTS RESERVED.		MECHANICAL OUTLINE		PRINT VERSION NOT TO SCALE	
TITLE:  NI-1230S		DOCUMENT NO: 98ARB18247C		REV: F	
		CASE NUMBER: 375E-04		05 AUG 2005	
		STANDARD: NON-JEDEC			

Refer to the following documents to aid your design process.

**Application Notes**

- AN1955: Thermal Measurement Methodology of RF Power Amplifiers

**Engineering Bulletins**

- EB212: Using Data Sheet Impedances for RF LDMOS Devices

**Software**

- Electromigration MTTF Calculator
- RF High Power Model
- .s2p File

For Software, do a Part Number search at <http://www.freescale.com>, and select the “Part Number” link. Go to the Software & Tools tab on the part’s Product Summary page to download the respective tool.

**REVISION HISTORY**

The following table summarizes revisions to this document.

Revision	Date	Description
0	Oct. 2009	• Initial Release of Data Sheet
1	Nov. 2009	• Removed Typical $P_{out}$ @ 1 dB Compression Point bullet from p. 1, and P1dB from the Typical Performance table, p. 3. P1dB was artificially low due to fixture tuning tradeoffs, i.e., fixture was tuned for back-off linearity versus optimum P1dB.
2	Oct. 2010	• Changed Human Body Model ESD rating from Class 1A to Class 2 to reflect recent ESD test results of the device, p. 2.

## **How to Reach Us:**

### **Home Page:**

[www.freescale.com](http://www.freescale.com)

### **Web Support:**

<http://www.freescale.com/support>

### **USA/Europe or Locations Not Listed:**

Freescale Semiconductor, Inc.  
 Technical Information Center, EL516  
 2100 East Elliot Road  
 Tempe, Arizona 85284  
 1-800-521-6274 or +1-480-768-2130  
[www.freescale.com/support](http://www.freescale.com/support)

### **Europe, Middle East, and Africa:**

Freescale Halbleiter Deutschland GmbH  
 Technical Information Center  
 Schatzbogen 7  
 81829 Muenchen, Germany  
 +44 1296 380 456 (English)  
 +46 8 52200080 (English)  
 +49 89 92103 559 (German)  
 +33 1 69 35 48 48 (French)  
[www.freescale.com/support](http://www.freescale.com/support)

### **Japan:**

Freescale Semiconductor Japan Ltd.  
 Headquarters  
 ARCO Tower 15F  
 1-8-1, Shimo-Meguro, Meguro-ku,  
 Tokyo 153-0064  
 Japan  
 0120 191014 or +81 3 5437 9125  
[support.japan@freescale.com](mailto:support.japan@freescale.com)

### **Asia/Pacific:**

Freescale Semiconductor China Ltd.  
 Exchange Building 23F  
 No. 118 Jianguo Road  
 Chaoyang District  
 Beijing 100022  
 China  
 +86 10 5879 8000  
[support.asia@freescale.com](mailto:support.asia@freescale.com)

### **For Literature Requests Only:**

Freescale Semiconductor Literature Distribution Center  
 1-800-441-2447 or +1-303-675-2140  
 Fax: +1-303-675-2150  
[LDCForFreescaleSemiconductor@hibbertgroup.com](mailto:LDCForFreescaleSemiconductor@hibbertgroup.com)

Information in this document is provided solely to enable system and software implementers to use Freescale Semiconductor products. There are no express or implied copyright licenses granted hereunder to design or fabricate any integrated circuits or integrated circuits based on the information in this document.

Freescale Semiconductor reserves the right to make changes without further notice to any products herein. Freescale Semiconductor makes no warranty, representation or guarantee regarding the suitability of its products for any particular purpose, nor does Freescale Semiconductor assume any liability arising out of the application or use of any product or circuit, and specifically disclaims any and all liability, including without limitation consequential or incidental damages. "Typical" parameters that may be provided in Freescale Semiconductor data sheets and/or specifications can and do vary in different applications and actual performance may vary over time. All operating parameters, including "Typicals", must be validated for each customer application by customer's technical experts. Freescale Semiconductor does not convey any license under its patent rights nor the rights of others. Freescale Semiconductor products are not designed, intended, or authorized for use as components in systems intended for surgical implant into the body, or other applications intended to support or sustain life, or for any other application in which the failure of the Freescale Semiconductor product could create a situation where personal injury or death may occur. Should Buyer purchase or use Freescale Semiconductor products for any such unintended or unauthorized application, Buyer shall indemnify and hold Freescale Semiconductor and its officers, employees, subsidiaries, affiliates, and distributors harmless against all claims, costs, damages, and expenses, and reasonable attorney fees arising out of, directly or indirectly, any claim of personal injury or death associated with such unintended or unauthorized use, even if such claim alleges that Freescale Semiconductor was negligent regarding the design or manufacture of the part.

Freescale™ and the Freescale logo are trademarks of Freescale Semiconductor, Inc. All other product or service names are the property of their respective owners.

© Freescale Semiconductor, Inc. 2009-2010. All rights reserved.