



Chipsmall Limited consists of a professional team with an average of over 10 year of expertise in the distribution of electronic components. Based in Hongkong, we have already established firm and mutual-benefit business relationships with customers from,Europe,America and south Asia,supplying obsolete and hard-to-find components to meet their specific needs.

With the principle of "Quality Parts,Customers Priority,Honest Operation,and Considerate Service",our business mainly focus on the distribution of electronic components. Line cards we deal with include Microchip,ALPS,ROHM,Xilinx,Pulse,ON,Everlight and Freescale. Main products comprise IC,Modules,Potentiometer,IC Socket,Relay,Connector.Our parts cover such applications as commercial,industrial, and automotives areas.

We are looking forward to setting up business relationship with you and hope to provide you with the best service and solution. Let us make a better world for our industry!



## Contact us

Tel: +86-755-8981 8866 Fax: +86-755-8427 6832

Email & Skype: info@chipsmall.com Web: www.chipsmall.com

Address: A1208, Overseas Decoration Building, #122 Zhenhua RD., Futian, Shenzhen, China



# RF Power Field Effect Transistors

## N-Channel Enhancement-Mode Lateral MOSFETs

Designed for broadband commercial and industrial applications with frequencies up to 1000 MHz. The high gain and broadband performance of these devices make them ideal for large-signal, common-source amplifier applications in 28 volt base station equipment.

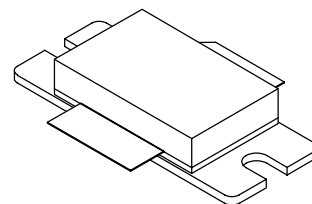
- Typical Single-Carrier W-CDMA Performance:  $V_{DD} = 28$  Volts,  $I_{DQ} = 1400$  mA,  $P_{out} = 58$  Watts Avg., Full Frequency Band, 3GPP Test Model 1, 64 DPCH with 50% Clipping, Channel Bandwidth = 3.84 MHz, Input Signal PAR = 7.5 dB @ 0.01% Probability on CCDF.  
 Power Gain — 21.2 dB  
 Drain Efficiency — 34%  
 Device Output Signal PAR — 6.3 dB @ 0.01% Probability on CCDF  
 ACPR @ 5 MHz Offset — -39.1 dBc in 3.84 MHz Channel Bandwidth
- Capable of Handling 10:1 VSWR, @ 32 Vdc, 880 MHz,  $P_{out} = 260$  W CW (3 dB Input Overdrive from Rated  $P_{out}$ ), Designed for Enhanced Ruggedness

### Features

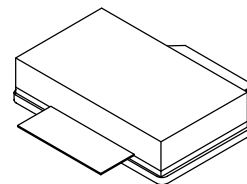
- 100% PAR Tested for Guaranteed Output Power Capability
- Characterized with Series Equivalent Large-Signal Impedance Parameters
- Internally Matched for Ease of Use
- Qualified Up to a Maximum of 32  $V_{DD}$  Operation
- Integrated ESD Protection
- Optimized for Doherty Applications
- RoHS Compliant
- In Tape and Reel. R3 Suffix = 250 Units per 56 mm, 13 inch Reel.

**MRFE6S9205HR3**  
**MRFE6S9205HSR3**

**880 MHz, 58 W AVG., 28 V**  
**SINGLE W-CDMA**  
**LATERAL N-CHANNEL**  
**RF POWER MOSFETs**



**CASE 465B-03, STYLE 1**  
**NI-880**  
**MRFE6S9205HR3**



**CASE 465C-02, STYLE 1**  
**NI-880S**  
**MRFE6S9205HSR3**

**Table 1. Maximum Ratings**

Rating	Symbol	Value	Unit
Drain-Source Voltage	$V_{DSS}$	-0.5, +66	Vdc
Gate-Source Voltage	$V_{GS}$	-0.5, +12	Vdc
Storage Temperature Range	$T_{stg}$	- 65 to +150	°C
Case Operating Temperature	$T_C$	150	°C
Operating Junction Temperature (1,2)	$T_J$	225	°C

**Table 2. Thermal Characteristics**

Characteristic	Symbol	Value (2,3)	Unit
Thermal Resistance, Junction to Case Case Temperature 80°C, 202 W CW Case Temperature 77°C, 58 W CW	$R_{\theta JC}$	0.27 0.33	°C/W

1. Continuous use at maximum temperature will affect MTTF.
2. MTTF calculator available at <http://www.freescale.com/rf>. Select Tools (Software & Tools)/Calculators to access the MTTF calculators by product.
3. Refer to AN1955, *Thermal Measurement Methodology of RF Power Amplifiers*. Go to <http://www.freescale.com/rf>. Select Documentation/Application Notes - AN1955.

**Table 3. ESD Protection Characteristics**

Test Methodology	Class
Human Body Model (per JESD22-A114)	Class 1C (Minimum)
Machine Model (per EIA/JESD22-A115)	Class B (Minimum)
Charge Device Model (per JESD22-C101)	Class IV (Minimum)

**Table 4. Electrical Characteristics** ( $T_C = 25^\circ\text{C}$  unless otherwise noted)

Characteristic	Symbol	Min	Typ	Max	Unit
<b>Off Characteristics</b>					
Zero Gate Voltage Drain Leakage Current ( $V_{DS} = 66\text{ Vdc}$ , $V_{GS} = 0\text{ Vdc}$ )	$I_{DSS}$	—	—	10	$\mu\text{Adc}$
Zero Gate Voltage Drain Leakage Current ( $V_{DS} = 28\text{ Vdc}$ , $V_{GS} = 0\text{ Vdc}$ )	$I_{DSS}$	—	—	1	$\mu\text{Adc}$
Gate-Source Leakage Current ( $V_{GS} = 5\text{ Vdc}$ , $V_{DS} = 0\text{ Vdc}$ )	$I_{GSS}$	—	—	10	$\mu\text{Adc}$

**On Characteristics**

Gate Threshold Voltage ( $V_{DS} = 10\text{ Vdc}$ , $I_D = 600\ \mu\text{Adc}$ )	$V_{GS(th)}$	1.4	2.1	2.9	Vdc
Gate Quiescent Voltage ( $V_{DD} = 28\text{ Vdc}$ , $I_D = 1400\ \text{mAdc}$ , Measured in Functional Test)	$V_{GS(Q)}$	2.2	2.9	3.7	Vdc
Drain-Source On-Voltage ( $V_{GS} = 10\text{ Vdc}$ , $I_D = 4.2\ \text{Adc}$ )	$V_{DS(on)}$	0.1	0.2	0.3	Vdc

**Dynamic Characteristics <sup>(1)</sup>**

Reverse Transfer Capacitance ( $V_{DS} = 28\text{ Vdc} \pm 30\ \text{mV(rms)ac}$ @ 1 MHz, $V_{GS} = 0\text{ Vdc}$ )	$C_{rss}$	—	1.63	—	pF
Output Capacitance ( $V_{DS} = 28\text{ Vdc} \pm 30\ \text{mV(rms)ac}$ @ 1 MHz, $V_{GS} = 0\text{ Vdc}$ )	$C_{oss}$	—	590	—	pF
Input Capacitance ( $V_{DS} = 28\text{ Vdc}$ , $V_{GS} = 0\text{ Vdc} \pm 30\ \text{mV(rms)ac}$ @ 1 MHz)	$C_{iss}$	—	491	—	pF

**Functional Tests** (In Freescale Test Fixture, 50 ohm system)  $V_{DD} = 28\text{ Vdc}$ ,  $I_{DQ} = 1400\ \text{mA}$ ,  $P_{out} = 58\ \text{W Avg. W-CDMA}$ ,  $f = 880\ \text{MHz}$ , Single-Carrier W-CDMA, 3.84 MHz Channel Bandwidth Carrier. ACPR measured in 3.84 MHz Channel Bandwidth @ 5 MHz Offset. PAR = 7.5 dB @ 0.01% Probability on CCDF.

Power Gain	$G_{ps}$	20	21.2	23	dB
Drain Efficiency	$\eta_D$	32	34	—	%
Output Peak-to-Average Ratio @ 0.01% Probability on CCDF	PAR	6	6.3	—	dB
Adjacent Channel Power Ratio	ACPR	—	-39.1	-37.5	dBc
Input Return Loss	IRL	—	-12.5	-8.5	dB

1. Part is internally matched on input.

(continued)



**Table 4. Electrical Characteristics** ( $T_C = 25^\circ\text{C}$  unless otherwise noted) (continued)

Characteristic	Symbol	Min	Typ	Max	Unit
<b>Typical Performances</b> (In Freescale Test Fixture, 50 ohm system) $V_{DD} = 28\text{ Vdc}$ , $I_{DQ} = 1400\text{ mA}$ , 865-900 MHz Bandwidth					
Video Bandwidth @ 220 W PEP $P_{out}$ where $IM3 = -30\text{ dBc}$ (Tone Spacing from 100 kHz to VBW) $\Delta IMD3 = IMD3 @\text{ VBW}$ frequency - $IMD3 @ 100\text{ kHz} < 1\text{ dBc}$ (both sidebands)	VBW	—	10	—	MHz
Gain Flatness in 35 MHz Bandwidth @ $P_{out} = 58\text{ W Avg.}$	$G_F$	—	0.315	—	dB
Average Deviation from Linear Phase in 35 MHz Bandwidth @ $P_{out} = 200\text{ W CW}$	$\Phi$	—	0.59	—	°
Average Group Delay @ $P_{out} = 200\text{ W CW}$ , $f = 880\text{ MHz}$	Delay	—	4.27	—	ns
Part-to-Part Insertion Phase Variation @ $P_{out} = 200\text{ W CW}$ , $f = 880\text{ MHz}$ , Six Sigma Window	$\Delta\Phi$	—	26.3	—	°
Gain Variation over Temperature ( $-30^\circ\text{C}$ to $+85^\circ\text{C}$ )	$\Delta G$	—	0.016	—	dB/°C
Output Power Variation over Temperature ( $-30^\circ\text{C}$ to $+85^\circ\text{C}$ )	$\Delta P_{1dB}$	—	0.006	—	dBm/°C

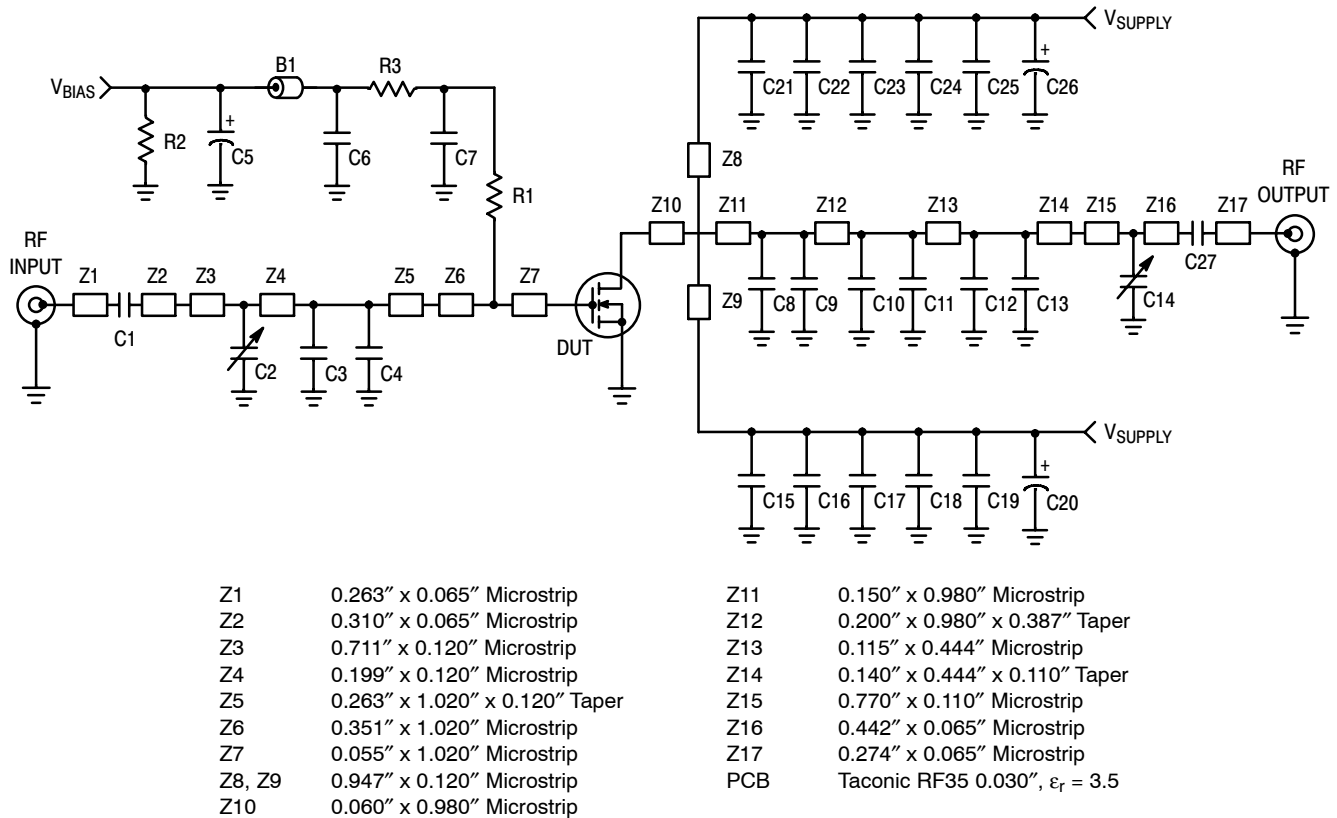


Figure 1. MRFE6S9205HR3(HSR3) Test Circuit Schematic

Table 5. MRFE6S9205HR3(HSR3) Test Circuit Component Designations and Values

Part	Description	Part Number	Manufacturer
B1	Short RF Bead	2743019447	Fair-Rite
C1, C7, C15, C16, C21, C22, C27	39 pF Chip Capacitors	ATC100B390JT500XT	ATC
C2, C14	0.8-8.0 pF Variable Capacitors, Gigatrim	27291SL	Johanson
C3, C4	5.1 pF Chip Capacitors	ATC100B5R1JT500XT	ATC
C5	33 $\mu$ F, 25 V Electrolytic Capacitor	EMVY350ADA330MF55G	Nippon Chemi-Con
C6, C17, C18, C19, C23, C24, C25	10 $\mu$ F, 50 V Chip Capacitors	GRM55DR61H106KA88B	Murata
C8, C9, C10, C11, C12, C13	6.8 pF Chip Capacitors	ATC100B6R8JT500XT	ATC
C20, C26	470 $\mu$ F, 63 V Electrolytic Capacitors	EKME630ELL471MK255	United Chemi-Con
R1, R3	3.3 $\Omega$ , 1/3 W Chip Resistors	CRCW12103R30FKEA	Vishay
R2	2.2 k $\Omega$ , 1/4 W Chip Resistor	CRCW12062K20FKEA	Vishay

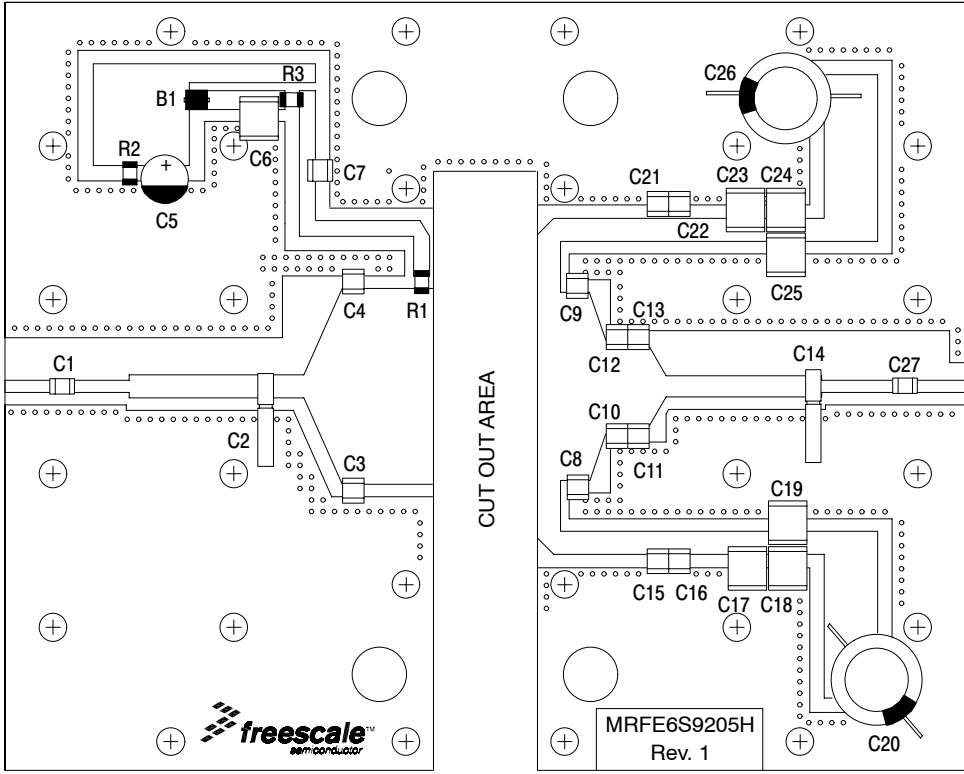
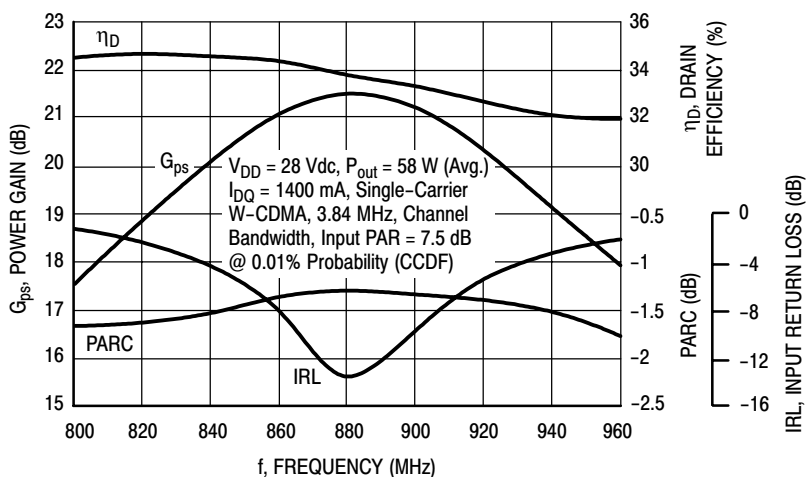
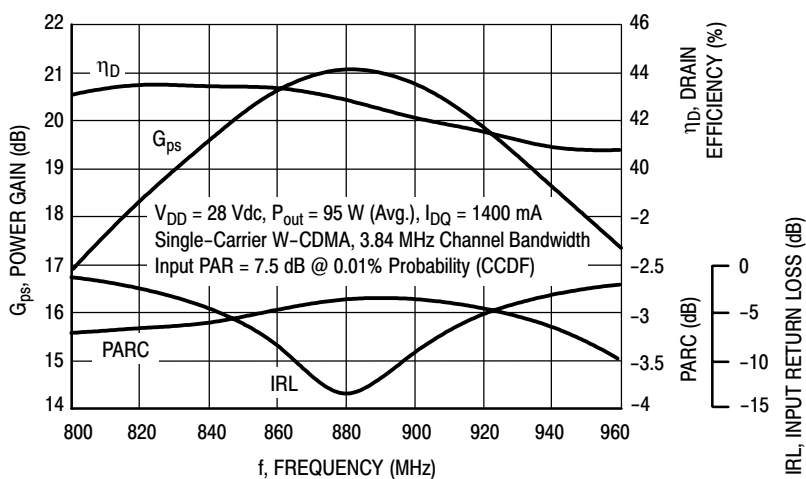


Figure 2. MRFE6S9205HR3(HSR3) Test Circuit Component Layout

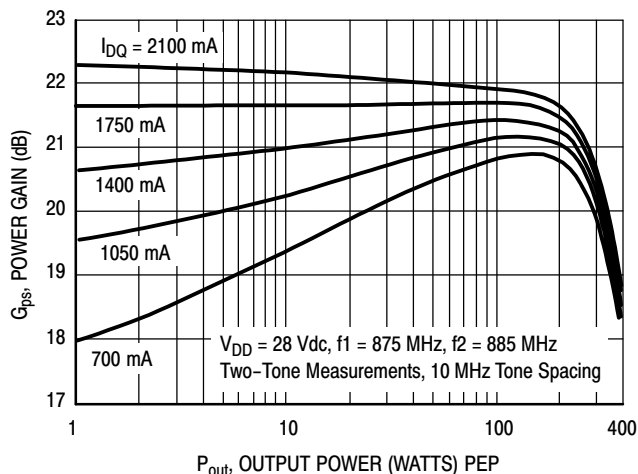
### TYPICAL CHARACTERISTICS



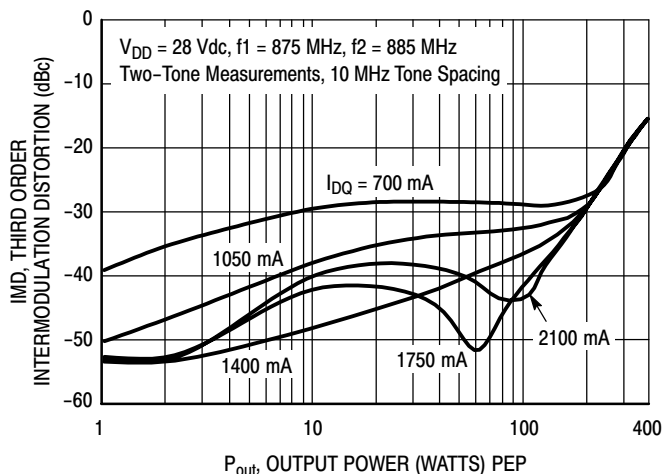
**Figure 3. Output Peak-to-Average Ratio Compression (PARC) Broadband Performance @  $P_{out} = 58$  Watts Avg.**



**Figure 4. Output Peak-to-Average Ratio Compression (PARC) Broadband Performance @  $P_{out} = 95$  Watts Avg.**

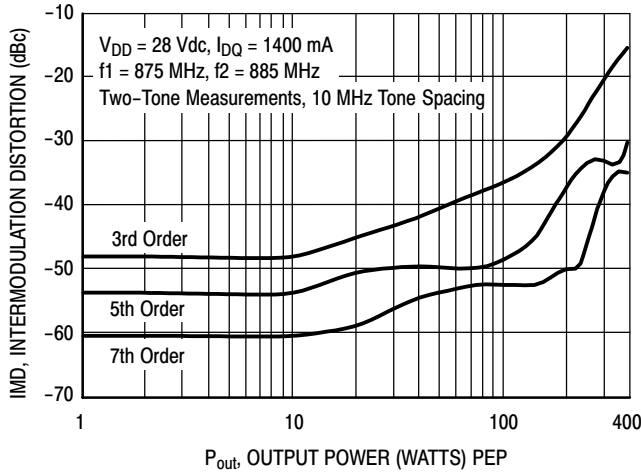


**Figure 5. Two-Tone Power Gain versus Output Power**

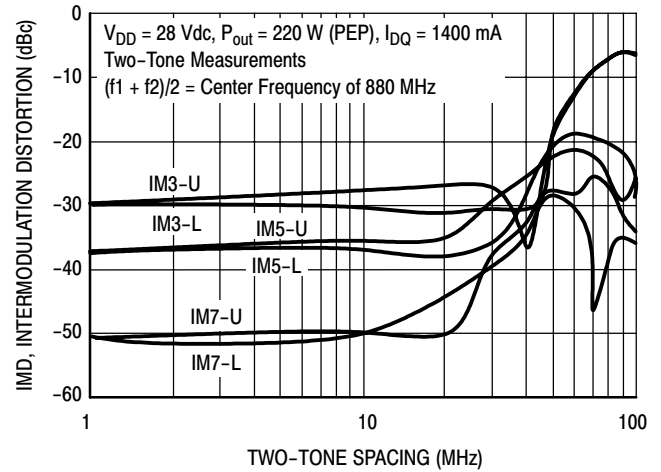


**Figure 6. Third Order Intermodulation Distortion versus Output Power**

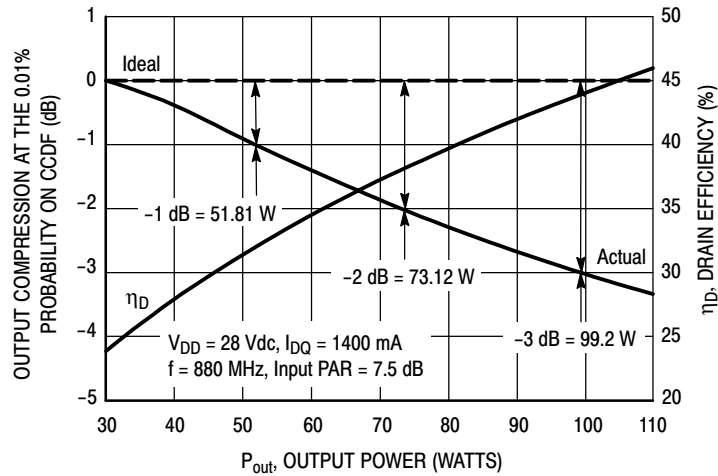
## TYPICAL CHARACTERISTICS



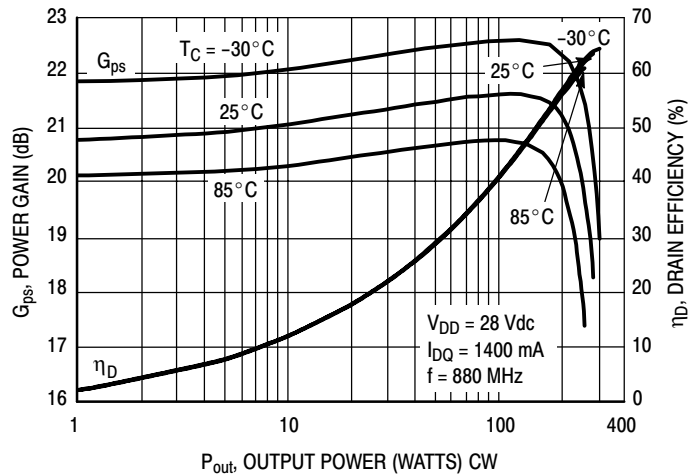
**Figure 7. Intermodulation Distortion Products versus Output Power**



**Figure 8. Intermodulation Distortion Products versus Output Power**



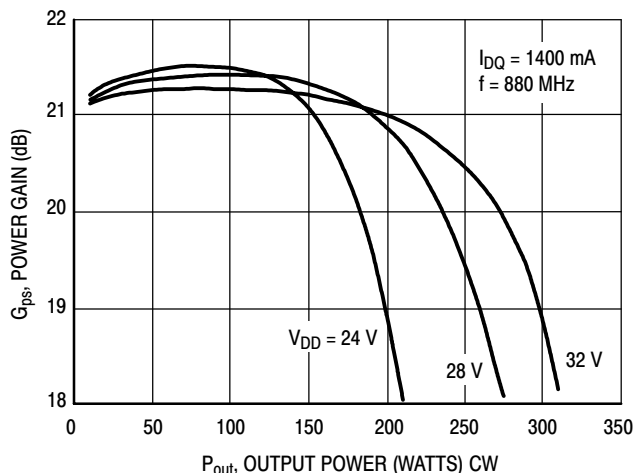
**Figure 9. Output Peak-to-Average Ratio Compression (PARC) versus Output Power**



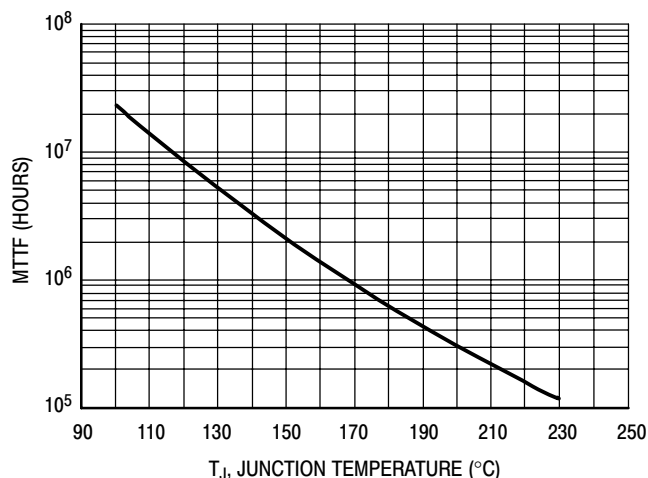
**Figure 10. Power Gain and Drain Efficiency versus CW Output Power**



## TYPICAL CHARACTERISTICS



**Figure 11. Power Gain versus Output Power**

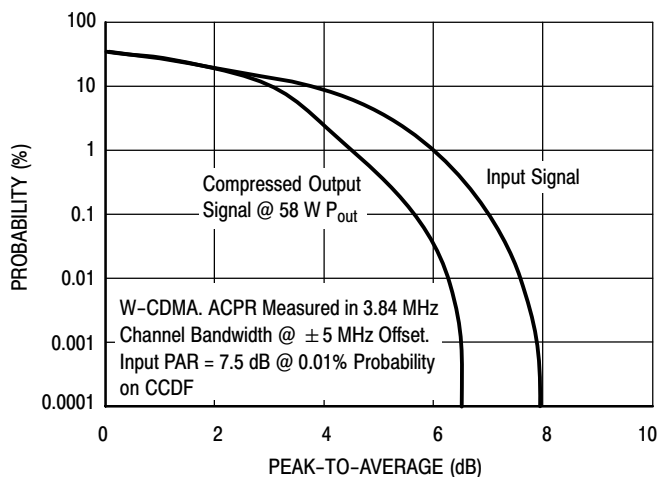


This above graph displays calculated MTTF in hours when the device is operated at  $V_{DD} = 28$  Vdc,  $P_{out} = 58$  W Avg., and  $\eta_D = 34\%$ .

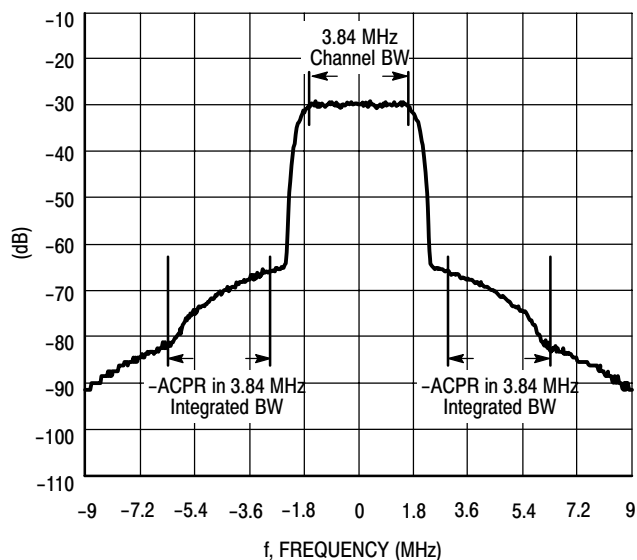
MTTF calculator available at <http://www.freescale.com/rf>. Select Tools (Software & Tools)/Calculators to access MTTF calculators by product.

**Figure 12. MTTF versus Junction Temperature**

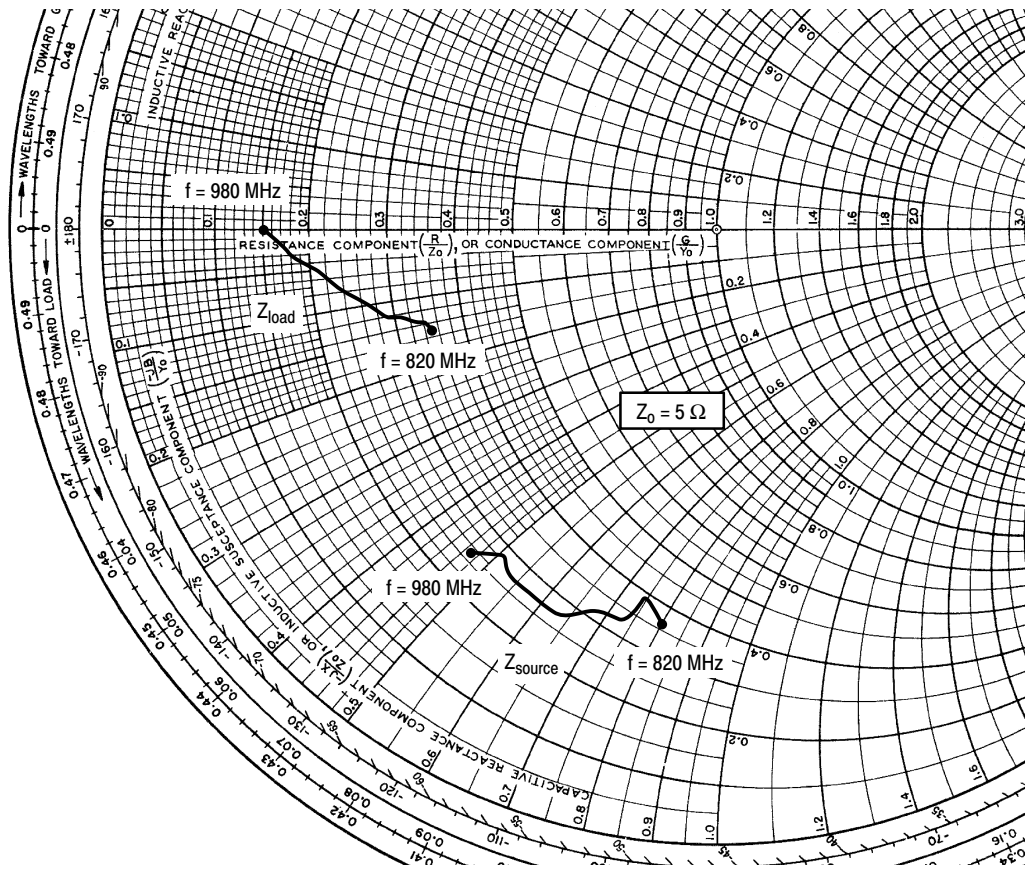
## W-CDMA TEST SIGNAL



**Figure 13. CCDF W-CDMA 3GPP, Test Model 1, 64 DPCH, 50% Clipping, Single-Carrier Test Signal**



**Figure 14. Single-Carrier W-CDMA Spectrum**



$V_{DD} = 28 \text{ Vdc}$ ,  $I_{DQ} = 1400 \text{ mA}$ ,  $P_{out} = 58 \text{ W Avg.}$

f MHz	$Z_{source}$ $\Omega$	$Z_{load}$ $\Omega$
820	1.80 - j4.00	1.75 - j0.73
840	1.88 - j3.76	1.68 - j0.69
860	1.64 - j3.65	1.57 - j0.64
880	1.54 - j3.41	1.44 - j0.58
900	1.35 - j3.13	1.33 - j0.51
920	1.37 - j2.89	1.21 - j0.40
940	1.37 - j2.66	1.07 - j0.27
960	1.39 - j2.53	0.92 - j0.13
980	1.25 - j2.33	0.74 + j0.01

$Z_{source}$  = Test circuit impedance as measured from gate to ground.

$Z_{load}$  = Test circuit impedance as measured from drain to ground.

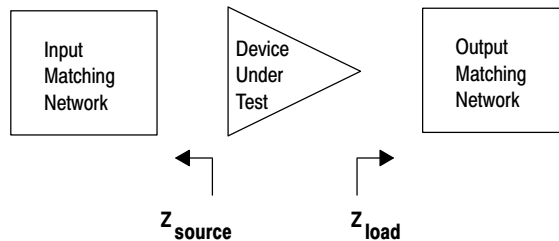
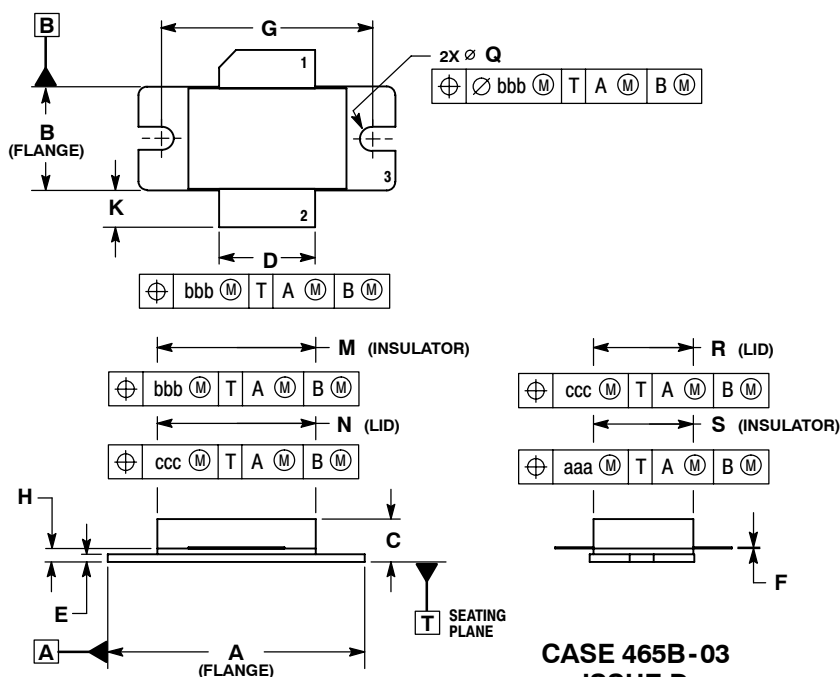


Figure 15. Series Equivalent Source and Load Impedance

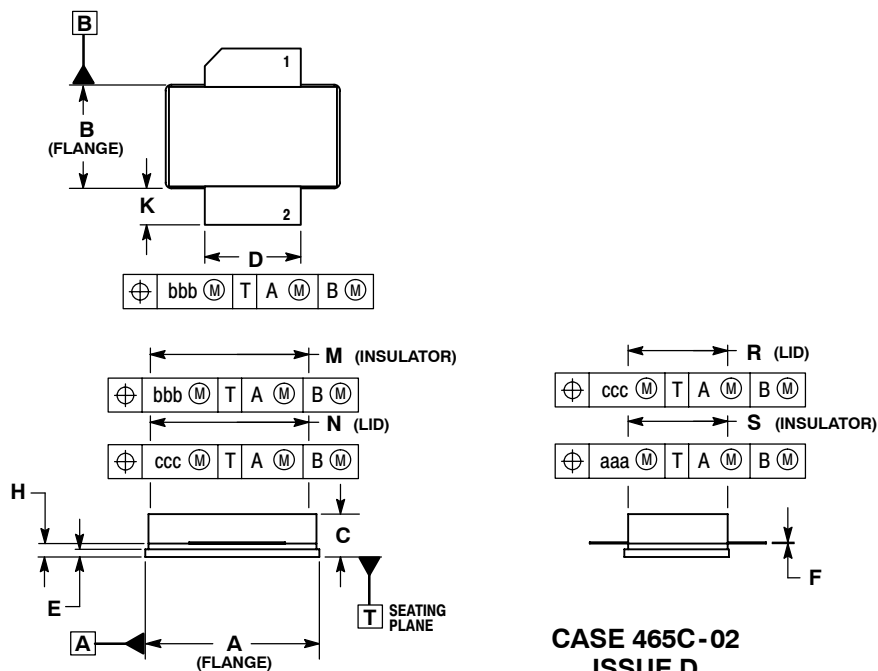
## PACKAGE DIMENSIONS



- NOTES:
1. DIMENSIONING AND TOLERANCING PER ANSI Y14.5M-1994.
  2. CONTROLLING DIMENSION: INCH.
  3. DIMENSION H IS MEASURED 0.030 (0.762) AWAY FROM PACKAGE BODY.
  4. DELETED

DIM	INCHES		MILLIMETERS	
	MIN	MAX	MIN	MAX
A	1.335	1.345	33.91	34.16
B	0.535	0.545	13.6	13.8
C	0.147	0.200	3.73	5.08
D	0.495	0.505	12.57	12.83
E	0.035	0.045	0.89	1.14
F	0.003	0.006	0.08	0.15
G	1.100 BSC		27.94 BSC	
H	0.057	0.067	1.45	1.70
K	0.170	0.210	4.32	5.33
M	0.872	0.888	22.15	22.55
N	0.871	0.889	19.30	22.60
Q	$\varnothing$ .118	$\varnothing$ .138	$\varnothing$ 3.00	$\varnothing$ 3.51
R	0.515	0.525	13.10	13.30
S	0.515	0.525	13.10	13.30
aaa	0.007 REF		0.178 REF	
bbb	0.010 REF		0.254 REF	
ccc	0.015 REF		0.381 REF	

- STYLE 1:  
PIN 1. DRAIN  
2. GATE  
3. SOURCE



- NOTES:
1. DIMENSIONING AND TOLERANCING PER ANSI Y14.5M-1994.
  2. CONTROLLING DIMENSION: INCH.
  3. DIMENSION H IS MEASURED 0.030 (0.762) AWAY FROM PACKAGE BODY.

DIM	INCHES		MILLIMETERS	
	MIN	MAX	MIN	MAX
A	0.905	0.915	22.99	23.24
B	0.535	0.545	13.60	13.80
C	0.147	0.200	3.73	5.08
D	0.495	0.505	12.57	12.83
E	0.035	0.045	0.89	1.14
F	0.003	0.006	0.08	0.15
H	0.057	0.067	1.45	1.70
K	0.170	0.210	4.32	5.33
M	0.872	0.888	22.15	22.55
N	0.871	0.889	19.30	22.60
R	0.515	0.525	13.10	13.30
S	0.515	0.525	13.10	13.30
aaa	0.007 REF		0.178 REF	
bbb	0.010 REF		0.254 REF	
ccc	0.015 REF		0.381 REF	

- STYLE 1:  
PIN 1. DRAIN  
2. GATE  
3. SOURCE

## PRODUCT DOCUMENTATION

Refer to the following documents to aid your design process.

### Application Notes

- AN1955: Thermal Measurement Methodology of RF Power Amplifiers

### Engineering Bulletins

- EB212: Using Data Sheet Impedances for RF LDMOS Devices

## REVISION HISTORY

The following table summarizes revisions to this document.

Revision	Date	Description
0	Oct. 2007	<ul style="list-style-type: none"> <li>• Initial Release of Data Sheet</li> </ul>

## **How to Reach Us:**

### **Home Page:**

[www.freescale.com](http://www.freescale.com)

### **Web Support:**

<http://www.freescale.com/support>

### **USA/Europe or Locations Not Listed:**

Freescale Semiconductor, Inc.  
Technical Information Center, EL516  
2100 East Elliot Road  
Tempe, Arizona 85284  
+1-800-521-6274 or +1-480-768-2130  
[www.freescale.com/support](http://www.freescale.com/support)

### **Europe, Middle East, and Africa:**

Freescale Halbleiter Deutschland GmbH  
Technical Information Center  
Schatzbogen 7  
81829 Muenchen, Germany  
+44 1296 380 456 (English)  
+46 8 52200080 (English)  
+49 89 92103 559 (German)  
+33 1 69 35 48 48 (French)  
[www.freescale.com/support](http://www.freescale.com/support)

### **Japan:**

Freescale Semiconductor Japan Ltd.  
Headquarters  
ARCO Tower 15F  
1-8-1, Shimo-Meguro, Meguro-ku,  
Tokyo 153-0064  
Japan  
0120 191014 or +81 3 5437 9125  
[support.japan@freescale.com](mailto:support.japan@freescale.com)

### **Asia/Pacific:**

Freescale Semiconductor Hong Kong Ltd.  
Technical Information Center  
2 Dai King Street  
Tai Po Industrial Estate  
Tai Po, N.T., Hong Kong  
+800 2666 8080  
[support.asia@freescale.com](mailto:support.asia@freescale.com)

### **For Literature Requests Only:**

Freescale Semiconductor Literature Distribution Center  
P.O. Box 5405  
Denver, Colorado 80217  
1-800-441-2447 or 303-675-2140  
Fax: 303-675-2150  
[LDCForFreescaleSemiconductor@hibbertgroup.com](mailto:LDCForFreescaleSemiconductor@hibbertgroup.com)

Information in this document is provided solely to enable system and software implementers to use Freescale Semiconductor products. There are no express or implied copyright licenses granted hereunder to design or fabricate any integrated circuits or integrated circuits based on the information in this document.

Freescale Semiconductor reserves the right to make changes without further notice to any products herein. Freescale Semiconductor makes no warranty, representation or guarantee regarding the suitability of its products for any particular purpose, nor does Freescale Semiconductor assume any liability arising out of the application or use of any product or circuit, and specifically disclaims any and all liability, including without limitation consequential or incidental damages. "Typical" parameters that may be provided in Freescale Semiconductor data sheets and/or specifications can and do vary in different applications and actual performance may vary over time. All operating parameters, including "Typicals", must be validated for each customer application by customer's technical experts. Freescale Semiconductor does not convey any license under its patent rights nor the rights of others. Freescale Semiconductor products are not designed, intended, or authorized for use as components in systems intended for surgical implant into the body, or other applications intended to support or sustain life, or for any other application in which the failure of the Freescale Semiconductor product could create a situation where personal injury or death may occur. Should Buyer purchase or use Freescale Semiconductor products for any such unintended or unauthorized application, Buyer shall indemnify and hold Freescale Semiconductor and its officers, employees, subsidiaries, affiliates, and distributors harmless against all claims, costs, damages, and expenses, and reasonable attorney fees arising out of, directly or indirectly, any claim of personal injury or death associated with such unintended or unauthorized use, even if such claim alleges that Freescale Semiconductor was negligent regarding the design or manufacture of the part.

Freescale™ and the Freescale logo are trademarks of Freescale Semiconductor, Inc. All other product or service names are the property of their respective owners.

© Freescale Semiconductor, Inc. 2007. All rights reserved.