



Chipsmall Limited consists of a professional team with an average of over 10 year of expertise in the distribution of electronic components. Based in Hongkong, we have already established firm and mutual-benefit business relationships with customers from,Europe,America and south Asia,supplying obsolete and hard-to-find components to meet their specific needs.

With the principle of “Quality Parts,Customers Priority,Honest Operation,and Considerate Service”,our business mainly focus on the distribution of electronic components. Line cards we deal with include Microchip,ALPS,ROHM,Xilinx,Pulse,ON,Everlight and Freescale. Main products comprise IC,Modules,Potentiometer,IC Socket,Relay,Connector.Our parts cover such applications as commercial,industrial, and automotives areas.

We are looking forward to setting up business relationship with you and hope to provide you with the best service and solution. Let us make a better world for our industry!



Contact us

Tel: +86-755-8981 8866 Fax: +86-755-8427 6832

Email & Skype: info@chipsmall.com Web: www.chipsmall.com

Address: A1208, Overseas Decoration Building, #122 Zhenhua RD., Futian, Shenzhen, China



DP-100 SERIES Ver.2

Related Information	■ General terms and conditions..... F-7	■ Sensor selection guide P.731~
	■ Glossary of terms..... P.1469	■ General precautions P.1472
	■ Korea's S-mark..... P.1506	

- FIBER SENSORS
- LASER SENSORS
- PHOTOELECTRIC SENSORS
- MICRO PHOTOELECTRIC SENSORS
- AREA SENSORS
- LIGHT CURTAINS / SAFETY COMPONENTS
- PRESSURE / FLOW SENSORS**
- INDUCTIVE PROXIMITY SENSORS
- PARTICULAR USE SENSORS
- SENSOR OPTIONS
- SIMPLE WIRE-SAVING UNITS
- WIRE-SAVING SYSTEMS
- MEASUREMENT SENSORS
- STATIC ELECTRICITY PREVENTION DEVICES
- LASER MARKERS
- PLC
- HUMAN MACHINE INTERFACES
- ENERGY CONSUMPTION VISUALIZATION COMPONENTS
- FA COMPONENTS
- MACHINE VISION SYSTEMS
- UV CURING SYSTEMS
- Selection Guide
- Pressure/Digital Display
- Pressure/Head-separated
- Flow
- DP-100**
- DP-M

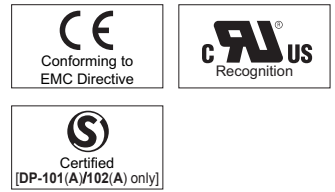

* Passed the UL 991 Environment Test

* UL 61010C-1 compatible, Passed the UL 991 Environment Test based on SEMI S2-0200. [Category applicable for semiconductor manufacturing: TWW2, Process Equipment] [Applicable standards: UL 61010C-1] [Additional test / evaluation standards as per intended use: UL 991, SEMI S2-0200]



Dual 3-color display makes operation easier!

Achieved further efficiency with 4 upgrades, keeping the same operability

UPGRADE 1

Superior visibility Improved visibility in Digital Display

Improvements to the digital display deliver a wide viewing angle along with increased clarity. The display pressure range and set pressure range have also been increased.



UPGRADE 2

Long-distance transmission of analog output Addition of analog current output capability to multifunctional models

Users can now select either voltage output or current output as analog output according to their application.

APPLICATIONS

Confirming suction of electronic component

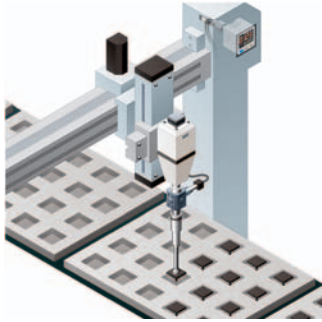

Confirming reference pressure

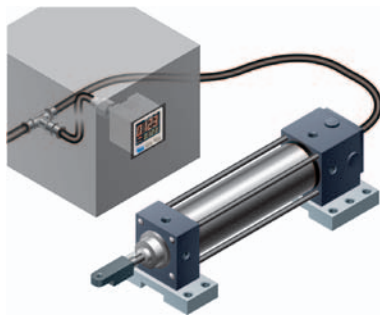

Air-leak test for PET bottles

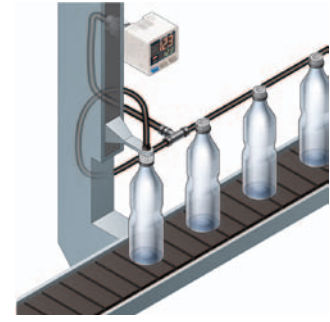
**UPGRADE 3****Reduced environmental impact****14% lower power consumption (during normal operation)**

Thanks to a redesign of its circuitry, power consumption of the low-power-consumption **DP-100** series during normal operation has been reduced by 14%. The display is shut off entirely during ECO / FULL mode operation for power savings of up to 50% compared to normal operation, and display brightness is lowered during ECO / STD mode operation for power savings of up to 30% compared to normal operation.

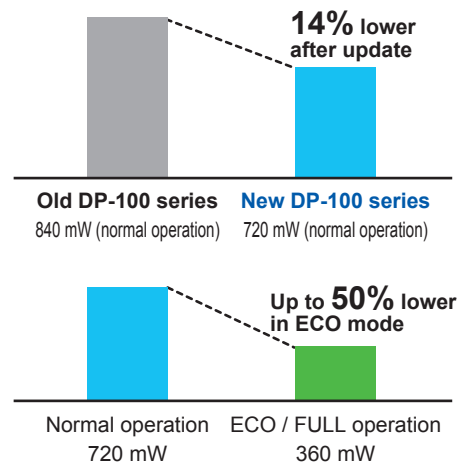
**UPGRADE 4****Enhanced power circuitry****Addition of a reverse polarity protection circuit to the transistor output circuit**

To prevent from breakage due to miswiring.

“Current value” and “threshold value” can be checked at the same time!**Dual display allows direct setting of threshold value**

Equipped with a 30 mm 1.181 in square compact-sized dual display. The current value and the threshold value can be checked at the same time, so the threshold value can be set and checked smoothly without switching to another screen mode. ON / OFF operations still continue while the threshold values are being set, so setting to the same sensitivity as dial control-type sensors is possible. Key lock function is equipped as well.

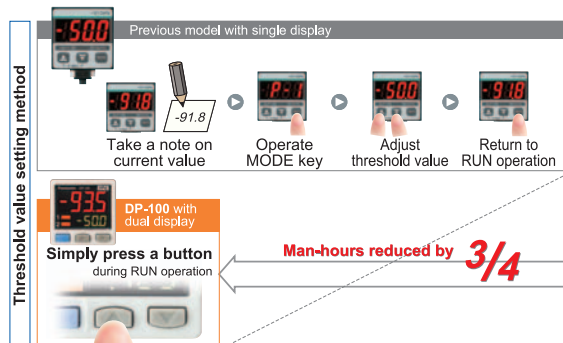

FIBER SENSORS

LASER SENSORS

PHOTOELECTRIC SENSORS

MICRO PHOTOELECTRIC SENSORS

AREA SENSORS

LIGHT CURTAINS / SAFETY COMPONENTS

PRESSURE / FLOW SENSORS

INDUCTIVE PROXIMITY SENSORS

PARTICULAR USE SENSORS

SENSOR OPTIONS

SIMPLE WIRE-SAVING UNITS

WIRE-SAVING SYSTEMS

MEASUREMENT SENSORS

STATIC ELECTRICITY PREVENTION DEVICES

LASER MARKERS

PLC

HUMAN MACHINE INTERFACES

ENERGY CONSUMPTION VISUALIZATION COMPONENTS

FA COMPONENTS

MACHINE VISION SYSTEMS

UV CURING SYSTEMS

Selection Guide

Pressure/ Digital Display

Pressure/ Head-separated

Flow

DP-100**DP-M**

- FIBER SENSORS
- LASER SENSORS
- PHOTOELECTRIC SENSORS
- MICRO PHOTOELECTRIC SENSORS
- AREA SENSORS
- LIGHT CURTAINS / SAFETY COMPONENTS
- PRESSURE / FLOW SENSORS**
- INDUCTIVE PROXIMITY SENSORS
- PARTICULAR USE SENSORS
- SENSOR OPTIONS
- SIMPLE WIRE-SAVING UNITS
- WIRE-SAVING SYSTEMS
- MEASUREMENT SENSORS
- STATIC ELECTRICITY PREVENTION DEVICES
- LASER MARKERS
- PLC
- HUMAN MACHINE INTERFACES
- ENERGY CONSUMPTION VISUALIZATION COMPONENTS
- FA COMPONENTS
- MACHINE VISION SYSTEMS
- UV CURING SYSTEMS
- Selection Guide
- Pressure/Digital Display
- Pressure/Head-separated
- Flow

3-color display (Red, Green, Orange)

The main display changes color in line with changes in the status of output ON / OFF operation, and it also changes color while setting is in progress. The sensor status can therefore be understood easily, and operating errors can be reduced.

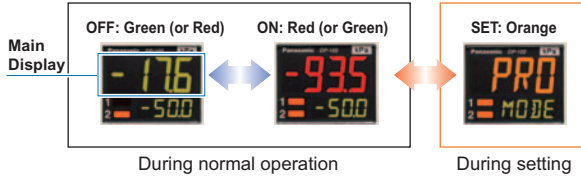

Readable digital display!

Alphanumeric indication in 12 segments is used. This improved visual checking.



BASIC PERFORMANCE

All models in the line-up are compound pressure types

No sensor settings are required to switch between positive pressure and negative pressure, so that the number of registered part numbers can be decreased.

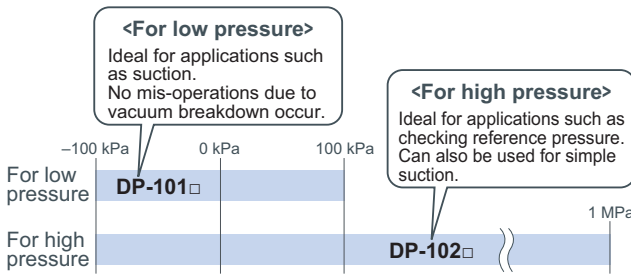

High performance accomplished Low pressure type

The low pressure type displays measurements in 0.1 kPa at a resolution of 1/2,000 and has a response time of 2.5 ms (variable up to 5,000 ms), ±0.5 % F.S. temperature characteristics and ±0.1 % F.S. repeatability, giving it high performance.

- Resolution: 1/2,000
- Response time: 2.5 ms
- Temperature characteristics: ±0.5 % F.S.
- Repeatability: ±0.1 % F.S.



Displays measurements in 0.1 kPa

FUNCTIONS

Copy function reduces man-hours and human error

Sensors can be connected to a master sensor one by one, and a copy of the setting details for the master sensor can be transmitted as data to other sensors. If making the same settings for multiple sensors, this prevents setting errors among other sensors and in addition, when machinery design are changed, there would be less change in work orders.

Copying via wiring

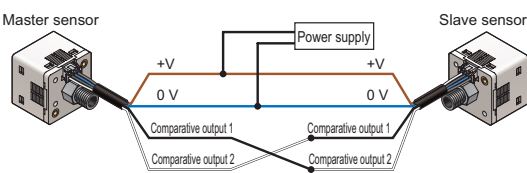

Note: Settings cannot be copied from the new version (Ver. 2) to the old version. However, settings can be copied from the old version to the new version (Ver. 2).

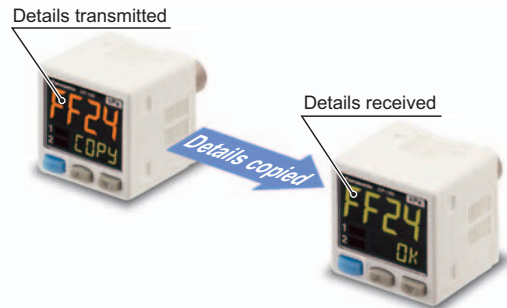

The sensor's setting operation mode has a 3-level configuration to suit the frequency of use

The setting levels are clearly separated into "RUN mode" for operation settings that are carried out daily, "MENU SETTING mode" for basic settings, and "PRO mode" for special and detailed setting. These make setting operations easy to understand and easy to carry out.



FUNCTIONS**Equipped with independent dual output and three output modes****Standard type**

Equipped with two independent comparative outputs, and separate sensing modes can be selected for each of them. Since there are two comparative outputs, one of the comparative outputs can even be used for alarm output. In addition, output, which is not being used, can be disabled.

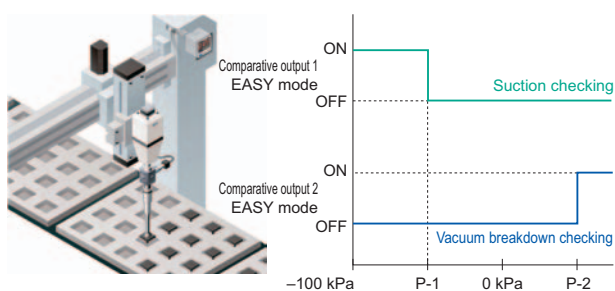
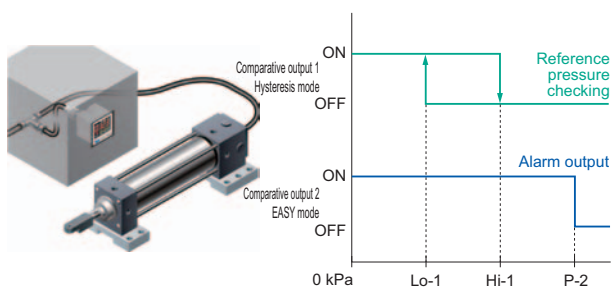
Vacuum breakdown can also be notified during suction applications!**Reference pressure alarm output is possible during reference pressure checking!****NEW****Possible to switch over analog output and external input****Multi-function type**

Multi-function type of Ver. 2 is newly equipped with analog current output, in addition to analog voltage output. Multi-function type that enables the selection of analog output (voltage / current) or external input (auto-reference / remote zero-adjustment) is available. It complies a wide range of applications.

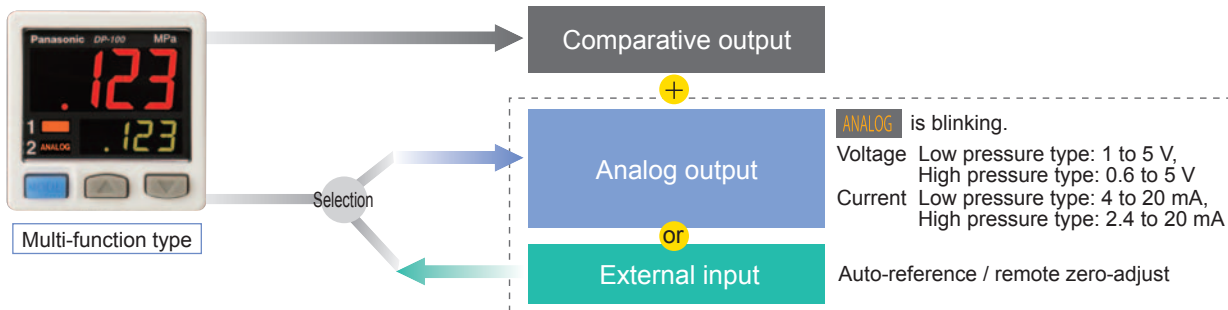
**① EASY mode**

This mode is used for comparative output ON / OFF control.

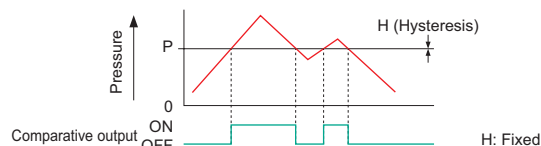

Notes: 1) Hysteresis can be fixed to one of eight different levels.
2) "P-1" appears in the sub display for comparative output 1, and "P-2" appears for comparative output 2.

② Hysteresis mode

This mode is used for setting comparative output hysteresis to the desired level and for carrying out ON / OFF control.

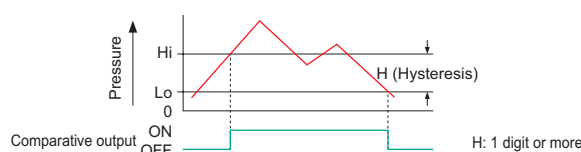

Note: "Hi-1" or "Lo-1" appears in the sub display for comparative output 1, and "Hi-2" or "Lo-2" appears for comparative output 2.

③ Window comparator mode

This mode is used for setting comparative output ON and OFF at pressures within the setting range.

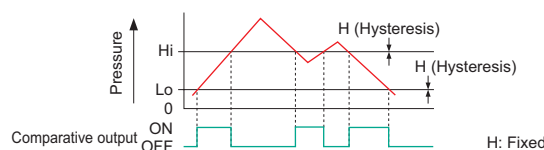

Notes: 1) Hysteresis can be fixed to one of eight different levels.
2) "Hi-1" or "Lo-1" appears in the sub display for comparative output 1, and "Hi-2" or "Lo-2" appears for comparative output 2.

FIBER
SENSORSLASER
SENSORSPHOTOELECTRIC
SENSORSMICRO
PHOTOELECTRIC
SENSORSAREA
SENSORSLIGHT CURTAINS /
SAFETY
COMPONENTS**PRESSURE /
FLOW
SENSORS**INDUCTIVE
PROXIMITY
SENSORSPARTICULAR
USE SENSORSSENSOR
OPTIONSSIMPLE
WIRE-SAVING
UNITSWIRE-SAVING
SYSTEMSMEASUREMENT
SENSORSSTATIC ELECTRICITY
PREVENTION
DEVICESLASER
MARKERS

PLC

HUMAN MACHINE
INTERFACESENERGY CONSUMPTION
VISUALIZATION
COMPONENTS

FA COMPONENTS

MACHINE VISION
SYSTEMSUV CURING
SYSTEMSSelection
GuidePressure/
Digital DisplayPressure/
Head-separated

Flow

DP-100**DP-M**

- FIBER SENSORS
- LASER SENSORS
- PHOTOELECTRIC SENSORS
- MICRO PHOTOELECTRIC SENSORS
- AREA SENSORS
- LIGHT CURTAINS / SAFETY COMPONENTS
- PRESSURE / FLOW SENSORS**
- INDUCTIVE PROXIMITY SENSORS
- PARTICULAR USE SENSORS
- SENSOR OPTIONS
- SIMPLE WIRE-SAVING UNITS
- WIRE-SAVING SYSTEMS
- MEASUREMENT SENSORS
- STATIC ELECTRICITY PREVENTION DEVICES
- LASER MARKERS
- PLC
- HUMAN MACHINE INTERFACES
- ENERGY CONSUMPTION VISUALIZATION COMPONENTS
- FA COMPONENTS
- MACHINE VISION SYSTEMS
- UV CURING SYSTEMS

FUNCTIONS

Equipped with auto-reference / remote zero-adjustment functions, More precise pressure management is achieved with a minimum of effort Multi-function type

If the reference pressure of the device changes, two functions are selectable. One is auto-reference function, which partially shift the comparative output judgment level by the amount that the reference pressure shifts. The other is remote zero-adjustment function, which can reset the display value to zero via external input. These functions are ideal for places where the reference pressure fluctuates wildly, or where fine settings are required.

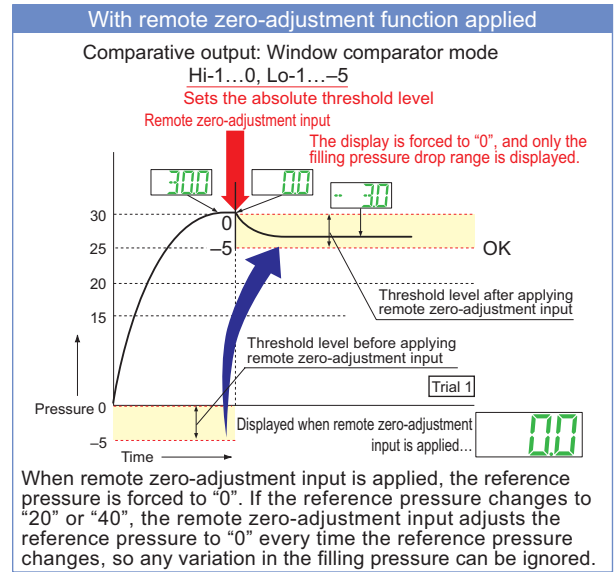
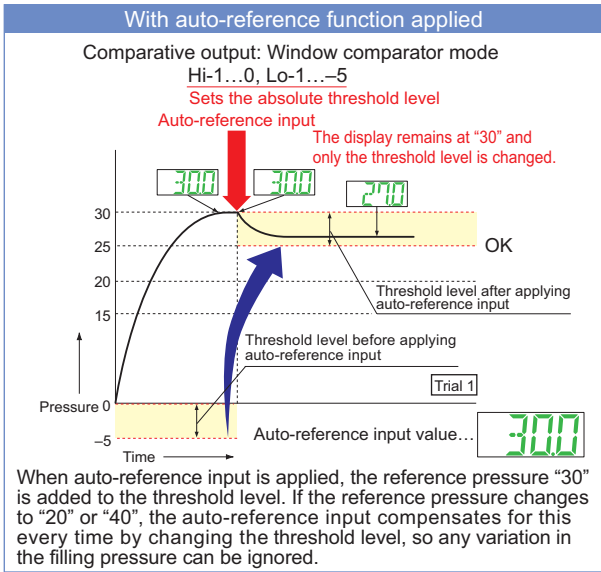
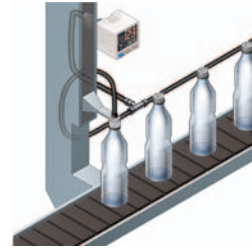

Sub display can be customized

The sub display can be set to indicate any other desired values or letters apart from the threshold value. This eliminates the need for tasks such as affixing a label to the device to indicate the normal pressure value.



Setting details can be recognized at a glance

The DP-100 setting details appear in the digital display. Because the settings are in numeric form that can be easily understood, it is useful such as when receiving technical support by telephone.

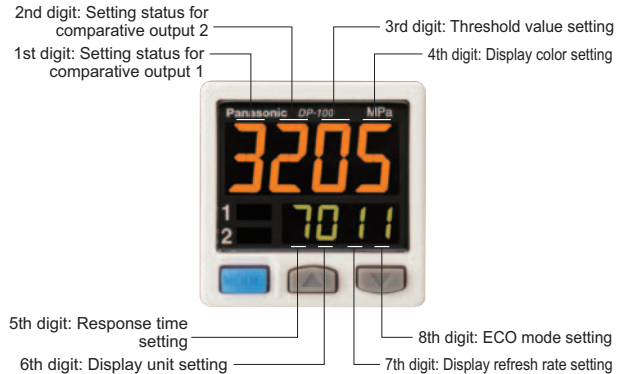

Peak hold and Bottom hold functions

The peak values and bottom values for fluctuating pressures can be displayed using the dual display.



Energy-saving design! Equipped with an ECO mode

This mode lowers the display luminance to cut power consumption by approximately 30%. The displays can also be turned off completely to achieve a power saving of approximately 40%.

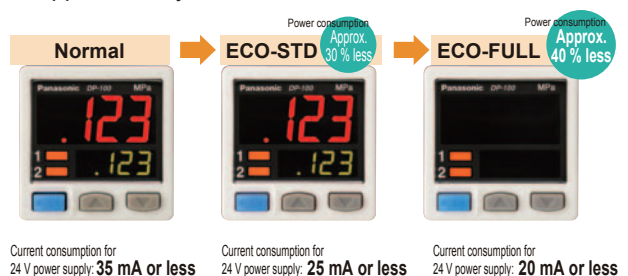

- Selection Guide
- Pressure/Digital Display
- Pressure/Head-separated
- Flow

DP-100 DP-M

Current consumption for 24 V power supply: **35 mA or less** Current consumption for 24 V power supply: **25 mA or less** Current consumption for 24 V power supply: **20 mA or less**

MOUNTING**Tight installation to panels is possible**

An exclusive mounting bracket that is suitable for 1 to 6 mm 0.039 to 0.236 in panel thickness is available.

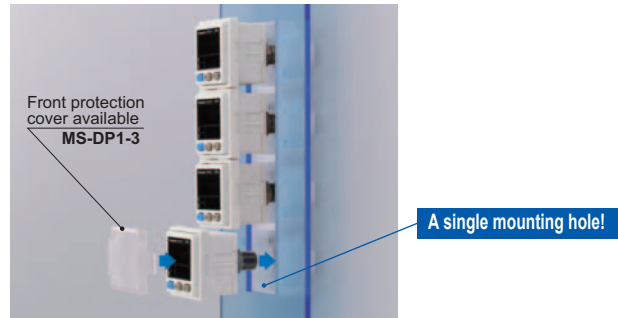

An exclusive mounting bracket (MS-DP1-1) that supports tight installation is available

Space savings can also be achieved even when an L-shaped mounting bracket is used.

• MS-DP1-1



Ceiling mounting



Floor mounting

• MS-DP1-5

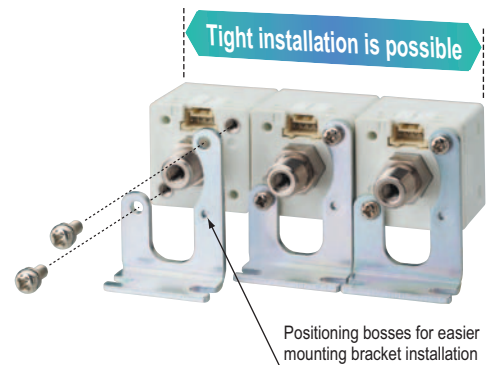

Rear mounting

**Cable can be connected with one-touch**

Connector attached cable (2 m 6.562 ft), as an accessory, can be connected easily with one-touch connection.

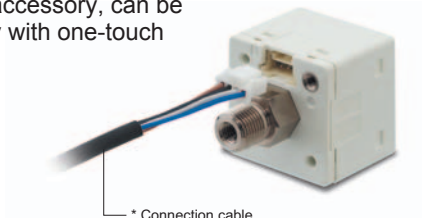

* Options: 1 m 3.281 ft / 3 m 9.843 ft / 5 m 16.404 ft types are also available.

Types without connector attached cable are also available**DP-10□-J**

Commercially-available connectors can be used for cable connections. Cables in required length can be used, so this contributes to reduction in waste of unwanted cables.

Environmentally friendly



* Refer to p.743 for recommended commercially-available connectors.

FIBER SENSORS

LASER SENSORS

PHOTOELECTRIC SENSORS

MICRO PHOTOELECTRIC SENSORS

AREA SENSORS

LIGHT CURTAINS / SAFETY COMPONENTS

PRESSURE / FLOW SENSORS

INDUCTIVE PROXIMITY SENSORS

PARTICULAR USE SENSORS

SENSOR OPTIONS

SIMPLE WIRE-SAVING UNITS

WIRE-SAVING SYSTEMS

MEASUREMENT SENSORS

STATIC ELECTRICITY PREVENTION DEVICES

LASER MARKERS

PLC

HUMAN MACHINE INTERFACES

ENERGY CONSUMPTION VISUALIZATION COMPONENTS

FA COMPONENTS

MACHINE VISION SYSTEMS

UV CURING SYSTEMS

Selection Guide

Pressure/ Digital Display

Pressure/ Head-separated

Flow

DP-100**DP-M**

- FIBER SENSORS
- LASER SENSORS
- PHOTOELECTRIC SENSORS
- MICRO PHOTOELECTRIC SENSORS
- AREA SENSORS
- LIGHT CURTAINS / SAFETY COMPONENTS
- PRESSURE / FLOW SENSORS**
- INDUCTIVE PROXIMITY SENSORS
- PARTICULAR USE SENSORS
- SENSOR OPTIONS
- SIMPLE WIRE-SAVING UNITS
- WIRE-SAVING SYSTEMS
- MEASUREMENT SENSORS
- STATIC ELECTRICITY PREVENTION DEVICES
- LASER MARKERS
- PLC
- HUMAN MACHINE INTERFACES
- ENERGY CONSUMPTION VISUALIZATION COMPONENTS
- FA COMPONENTS
- MACHINE VISION SYSTEMS
- UV CURING SYSTEMS

- Selection Guide
- Pressure/ Digital Display
- Pressure/ Head-separated
- Flow

- DP-100**
- DP-M**

VARIETIES

Short pressure port type is lightweight and takes up little space

DP-10□-M

Compact size with a depth of only 30 mm 1.181 in, so that it can easily fit into narrow spaces. Further, 10 g lighter than standard types. This reduces the loads on movable parts such as robot arms.

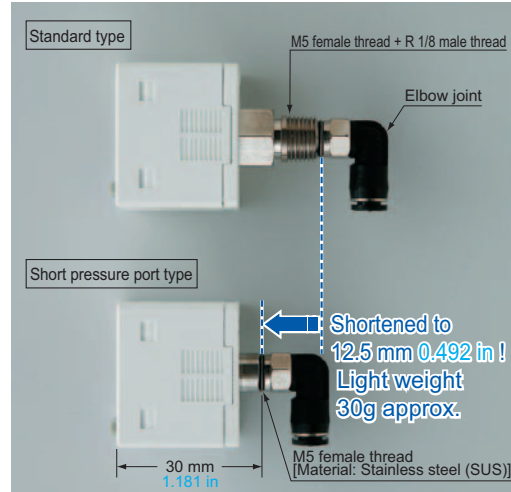

* The illustration shows connection using an elbow joint. The elbow joint is sold separately.

M8 plug-in connector types are also available (Only for Europe)

DP-11□-E-P-J

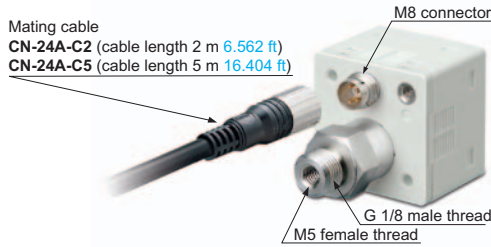

Flat installation on the wall by shifting the direction of the pressure port

For short pressure port type

By mounting the flat attachment to **DP-10□-M(-P)**, pressure port and cable can now be pulled out in downward, left or right directions. Flat mounting on surfaces such as the wall is made possible.

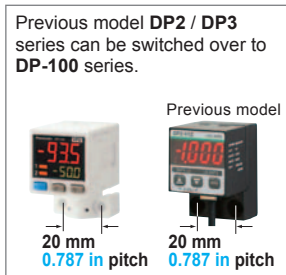
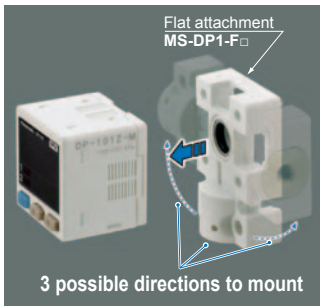

Model No.	Pressure port
MS-DP1-FM	M5 female thread
MS-DP1-FR	Rc1/8 female thread
MS-DP1-FN	NPT1/8 female thread
MS-DP1-FE	G1/8 female thread

Rc1/8 conversion bushing is available. Compatible with previous model

For short pressure port type

By equipping the push-in converter with **DP-10□-M(-P)**, pressure port can be converted from M5 female thread to Rc1/8 female thread.

Bore diameter conversion to the **DP2 / DP3** series is possible.

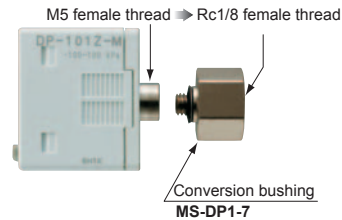

ORDER GUIDE

Type			Appearance	Rated pressure range	Model No.	Pressure port	Comparative output			
Standard pressure port type	Asia	Standard	For low pressure		-100.0 to +100.0 kPa	DP-101	M5 female thread + R 1/8 male thread	NPN open-collector transistor		
			For high pressure		-0.100 to +1.000 MPa	DP-102				
		Multi-function	For low pressure		-100.0 to +100.0 kPa	DP-101A				
			For high pressure		-0.100 to +1.000 MPa	DP-102A				
	Europe M8 plug-in connector type	Standard	For low pressure		-100.0 to +100.0 kPa	DP-101-E-P	M5 female thread + G 1/8 male thread	PNP open-collector transistor		
			For high pressure		-0.100 to +1.000 MPa	DP-102-E-P				
			Multi-function		For low pressure	-100.0 to +100.0 kPa			DP-101A-E-P	
					For high pressure	-0.100 to +1.000 MPa			DP-102A-E-P	
		Standard	For low pressure		-100.0 to +100.0 kPa	DP-111-E-P-J	M5 female thread + G 1/8 male thread		PNP open-collector transistor	
			For high pressure		-0.100 to +1.000 MPa	DP-112-E-P-J				
			Multi-function		For low pressure	-100.0 to +100.0 kPa				DP-111A-E-P-J
					For high pressure	-0.100 to +1.000 MPa				DP-112A-E-P-J
North America	Standard	For low pressure	* CN-14A-C2 (Connector attached) cable 2 m 6.562 ft is attached. (Excluding M8 plug-in) connector type	-100.0 to +100.0 kPa	DP-101-N	M5 female thread + NPT 1/8 male thread	NPN open-collector transistor			
		For high pressure		-0.100 to +1.000 MPa	DP-101-N-P		PNP open-collector transistor			
		Multi-function		For low pressure	-100.0 to +100.0 kPa		DP-102-N	NPN open-collector transistor		
				For high pressure	-0.100 to +1.000 MPa		DP-102-N-P	PNP open-collector transistor		
	Multi-function	For low pressure		-100.0 to +100.0 kPa	DP-101A-N		NPN open-collector transistor			
		For high pressure		-0.100 to +1.000 MPa	DP-101A-N-P		PNP open-collector transistor			
		Multi-function		For low pressure	-100.0 to +100.0 MPa		DP-102A-N	NPN open-collector transistor		
				For high pressure	-0.100 to +1.000 MPa		DP-102A-N-P	PNP open-collector transistor		
	Short pressure port type	Asia		Standard	For low pressure		-100.0 to +100.0 kPa	DP-101-M	M5 female thread	NPN open-collector transistor
					For high pressure		-0.100 to +1.000 MPa	DP-101-M-P		PNP open-collector transistor
				Multi-function	For low pressure		-100.0 to +100.0 kPa	DP-102-M		NPN open-collector transistor
					For high pressure		-0.100 to +1.000 MPa	DP-102-M-P		PNP open-collector transistor
Multi-function		For low pressure	-100.0 to +100.0 kPa	DP-101A-M	NPN open-collector transistor					
		For high pressure	-0.100 to +1.000 MPa	DP-101A-M-P	PNP open-collector transistor					
		Multi-function	For low pressure	-100.0 to +1.000 MPa	DP-102A-M	NPN open-collector transistor				
			For high pressure	-0.100 to +1.000 MPa	DP-102A-M-P	PNP open-collector transistor				

Type without connector attached cable

Type without connector attached cable **CN-14A-C2** is available.

When ordering this type, suffix "-J" to the end of Model No. (Excluding M8 plug-in connector type and short pressure port type.)

(e.g.) Type without connector attached cable of **DP-101-N** is "**DP-101-N-J**"

Accessory• **CN-14A-C2**

(Connector attached cable 2 m 6.562 ft)

FIBER
SENSORSLASER
SENSORSPHOTO-
ELECTRIC
SENSORSMICRO
PHOTO-
ELECTRIC
SENSORSAREA
SENSORSLIGHT
CURTAINS /
SAFETY
COMPONENTSPRESSURE /
FLOW
SENSORSINDUCTIVE
PROXIMITY
SENSORSPARTICULAR
USE
SENSORSSENSOR
OPTIONSSIMPLE
WIRE-SAVING
UNITSWIRE-SAVING
SYSTEMSMEASURE-
MENT
SENSORSSTATIC
ELECTRICITY
PREVENTION
DEVICESLASER
MARKERS

PLC

HUMAN
MACHINE
INTERFACESENERGY
CONSUMPTION
VISUALIZATION
COMPONENTSFA
COMPONENTSMACHINE
VISION
SYSTEMSUV
CURING
SYSTEMSSelection
GuidePressure/
Digital DisplayPressure/
Head-separated

Flow

DP-100

DP-M

OPTIONS

Designation	Model No.	Description	
Connector attached cable	CN-14A-C1	Length: 1 m 3.281 ft	0.2 mm ² 4-core cabtyre cable with connector on one end Cable outer diameter: ø3.7 mm ø0.146 in
	CN-14A-C2 (Note)	Length: 2 m 6.562 ft	
	CN-14A-C3	Length: 3 m 9.843 ft	
	CN-14A-C5	Length: 5 m 16.404 ft	
Connector attached cable (Flexible cable)	CN-14A-R-C1	Length: 1 m 3.281 ft	0.2 mm ² 4-core flexible cabtyre cable with connector on one end Cable outer diameter: ø3.7 mm ø0.146 in
	CN-14A-R-C2	Length: 2 m 6.562 ft	
	CN-14A-R-C3	Length: 3 m 9.843 ft	
	CN-14A-R-C5	Length: 5 m 16.404 ft	
M8 connector attached cable	CN-24A-C2	Length: 2 m 6.562 ft	For M8 plug-in connector type The connector on one end Cable outer diameter: ø4 mm ø0.157 in
	CN-24A-C5	Length: 5 m 16.404 ft	
Connector	CN-14A	Set of 10 housings and 40 contacts	
Sensor mounting bracket	MS-DP1-1	Allows sensors to be installed on the flooring or ceiling. Multiple sensors can also be mounted closely.	
	MS-DP1-5	Allows sensors to be installed on the wall. Multiple sensors can also be mounted closely.	
Panel mounting bracket	MS-DP1-2	Allows installation to panels with thickness of 1 to 6 mm 0.039 to 0.236 in . Multiple sensors can also be mounted closely.	
	MS-DP1-4	Allows replacement from DP2 / DP3 series to DP-100 series. For newly designed set-up, please use panel mounting bracket MS-DP1-2 for panel mounting.	
Front protection cover	MS-DP1-3	Protects the adjustment surfaces of sensors. (Can be attached when using the panel mounting bracket)	
Conversion bushing	MS-DP1-7	By equipping with DP-10-M(-P) , pressure port can be converted to Rc ¹ / ₈ female thread. Replacement from DP2 / DP3 series is possible.	
Flat attachment	MS-DP1-FM	M5 female thread	Pressure port and cable can now be pulled out in downward, left or right directions. Flat mounting on surfaces such as the wall is made possible.
	MS-DP1-FR	Rc ¹ / ₈ female thread	
	MS-DP1-FN	NPT ¹ / ₈ female thread	
	MS-DP1-FE	G ¹ / ₈ female thread	

Note: The connector attached cable **CN-14A-C2** is supplied with the **DP-100** series. (Excluding M8 plug-in connector type).

Panel mounting bracket, Front protection cover

- **MS-DP1-2**
- **MS-DP1-3**

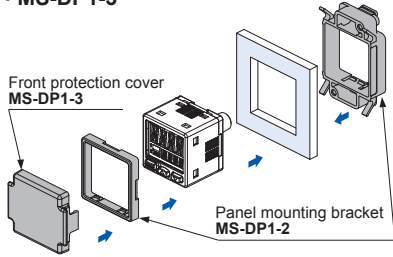

- **MS-DP1-4**

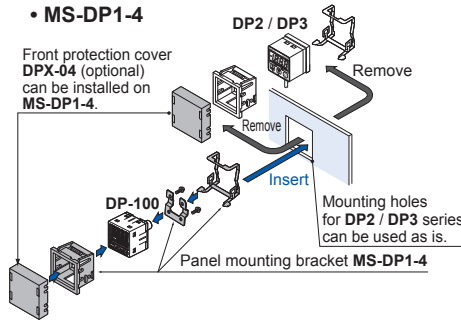

Flat attachment

- **MS-DP1-FM**
- **MS-DP1-FR**
- **MS-DP1-FN**
- **MS-DP1-FE**

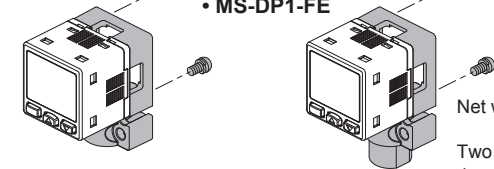

Net weight: **MS-DP1-FM** 15g approx.
MS-DP1-FR/FN/FE 25g approx.
Two M3 (length 8 mm **0.315 in**) screws,
two M4 (length 20 mm **0.787 in**) screws are attached.

Recommended connector

Contact: SPHD-001T-P0.5, Housing: PAP-04V-S
(Manufactured by J.S.T. Mfg. Co., Ltd.)
Note: Contact the manufacturer for details of the recommended products.

Recommended crimping tool

Model No.: YC-610R
(Manufactured by J.S.T. Mfg. Co., Ltd.)
Note: Contact the manufacturer for details of the recommended products.

Connector attached cable

- **CN-14A-C**
- **CN-14A-R-C**

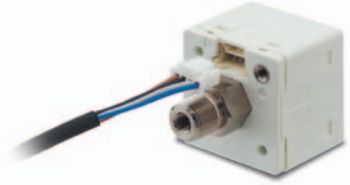

M8 connector attached cable

- **CN-24A-C**

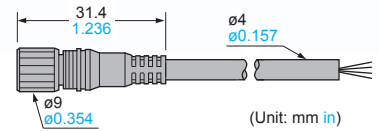

Sensor mounting bracket

- **MS-DP1-1**

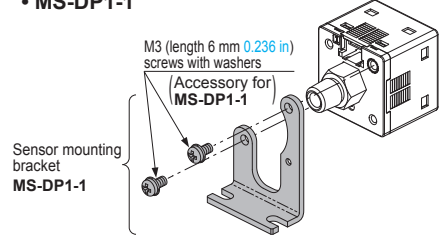

- **MS-DP1-5**

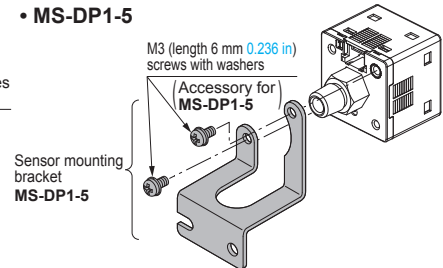

Conversion bushing

- **MS-DP1-7**

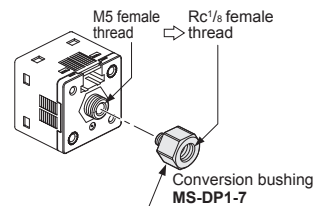

SPECIFICATIONS

Item	Model No.	Type	Standard		Multi-function	
			For low pressure	For high pressure	For low pressure	For high pressure
			DP-101(-M)(-P)	DP-102(-M)(-P)	DP-101A(-M)(-P)	DP-102A(-M)(-P)
		Asia (Note 2)				
		Europe				
		M8 plug-in connector type				
		North America (Note 2)				
Type of pressure			Gauge pressure			
Rated pressure range			-100.0 to +100.0 kPa	-0.100 to +1.000 MPa	-100.0 to +100.0 kPa	-0.100 to +1.000 MPa
Set pressure range			$\left\{ \begin{array}{l} -101.0 \text{ to } +101.0 \text{ kPa} \\ -1.030 \text{ to } +1.030 \text{ kgf/cm}^2 \\ -1.010 \text{ to } +1.010 \text{ bar} \\ -14.64 \text{ to } +14.64 \text{ psi} \\ -757 \text{ to } +757 \text{ mmHg} \\ -29.8 \text{ to } 29.8 \text{ inHg} \end{array} \right\}$	$\left\{ \begin{array}{l} -0.101 \text{ to } +1.010 \text{ MPa} \\ -101 \text{ to } +1,010 \text{ kPa} \\ -1.03 \text{ to } +10.30 \text{ kgf/cm}^2 \\ -1.01 \text{ to } +10.10 \text{ bar} \\ -14.6 \text{ to } +146.4 \text{ psi} \end{array} \right\}$	$\left\{ \begin{array}{l} -101.0 \text{ to } +101.0 \text{ kPa} \\ -1.030 \text{ to } +1.030 \text{ kgf/cm}^2 \\ -1.010 \text{ to } +1.010 \text{ bar} \\ -14.64 \text{ to } +14.64 \text{ psi} \\ -757 \text{ to } +757 \text{ mmHg} \\ -29.8 \text{ to } 29.8 \text{ inHg} \end{array} \right\}$	$\left\{ \begin{array}{l} -0.101 \text{ to } +1.010 \text{ MPa} \\ -101 \text{ to } +1,010 \text{ kPa} \\ -1.03 \text{ to } +10.30 \text{ kgf/cm}^2 \\ -1.01 \text{ to } +10.10 \text{ bar} \\ -14.6 \text{ to } +146.4 \text{ psi} \end{array} \right\}$
Pressure withstandability			500 kPa	1.5 MPa	500 kPa	1.5 MPa
Applicable fluid			Non-corrosive gas			
Selectable unit			For low pressure: kPa, kgf/cm ² , bar, psi, mmHg, inHg, For high pressure: MPa, kPa, kgf/cm ² , bar, psi			
Supply voltage			12 to 24 V DC $\pm 10\%$ Ripple P-P 10% or less			
Power consumption			Normal operation: 720 mW or less (Current consumption 30 mA or less at 24 V supply voltage) ECO mode: 480 mW or less at STD (Current consumption 20 mA or less at 24 V supply voltage) 360 mW or less at FULL (Current consumption 15 mA or less at 24 V supply voltage)			
Comparative output			<Asia (NPN output), North America (NPN output)> NPN open-collector transistor		<Asia (PNP output), Europe, North America (PNP output)> PNP open-collector transistor	
Comparative output 1, Comparative output 2 (Note 3)			<ul style="list-style-type: none"> Maximum sink current: 100 mA Applied voltage: 30 V DC or less (between comparative output and 0 V) Residual voltage: 2 V or less (at 100 mA sink current) 		<ul style="list-style-type: none"> Maximum source current: 100 mA Applied voltage: 30 V DC or less (between comparative output and +V) Residual voltage: 2 V or less (at 100 mA source current) 	
Output operation / Output modes			NO / NC (selectable by key operation) / EASY mode / Hysteresis mode / Window comparator mode			
Hysteresis			Minimum 1 digit (variable) (however, 2 digits when using psi unit)			
Repeatability			$\pm 0.1\%$ F.S. (within ± 2 digits)	$\pm 0.2\%$ F.S. (within ± 2 digits)	$\pm 0.1\%$ F.S. (within ± 2 digits)	$\pm 0.2\%$ F.S. (within ± 2 digits)
Response time			2.5 ms, 5 ms, 10 ms, 25 ms, 50 ms, 100 ms, 250 ms, 500 ms, 1,000 ms, 5,000 ms, selectable by key operation			
Short-circuit protection			Incorporated			
External input (Note 4) Auto-reference function / Remote zero-adjustment function			_____		<Asia (NPN output), North America (NPN output)> ON voltage: 0.4 V DC or less OFF voltage: 5 to 30 V DC, or open Input impedance: 10 k Ω approx. Input time: 1 ms or more	<Asia (PNP output), Europe, North America (PNP output)> ON voltage: 5 V to +V DC OFF voltage: 0.6 V DC or less, or open Input impedance: 10 k Ω approx. Input time: 1 ms or more
Analog voltage output (Note 4)			_____		Output voltage: 1 to 5 V DC Zero point: within 3 V $\pm 5\%$ F.S. Span: within 4 V $\pm 5\%$ F.S. Linearity: within $\pm 1\%$ F.S. Output impedance: 1 k Ω approx.	Output voltage: 0.6 to 5 V Zero point: within 1 V $\pm 5\%$ F.S. Span: within 4.4 V $\pm 5\%$ F.S. Linearity: within $\pm 1\%$ F.S. Output impedance: 1 k Ω approx.
Analog current output (Note 4)			_____		Output current: 4 to 20 mA Zero point: 12 mA $\pm 5\%$ F.S. Span: 16 mA $\pm 5\%$ F.S. Linearity: within $\pm 1\%$ F.S. Load resistance: 250 Ω (max.)	Output current: 2.4 to 20 mA Zero point: 4 mA $\pm 5\%$ F.S. Span: 17.6 mA $\pm 5\%$ F.S. Linearity: within $\pm 1\%$ F.S. Load resistance: 250 Ω (max.)
Display			4 digits + 4 digits 3-color LCD display (Display refresh rate: 250 ms, 500 ms, 1,000 ms, selectable by key operation)			
Displayable pressure range			$\left\{ \begin{array}{l} -101.0 \text{ to } +101.0 \text{ kPa} \\ -1.030 \text{ to } +1.030 \text{ kgf/cm}^2 \\ -1.010 \text{ to } +1.010 \text{ bar} \\ -14.64 \text{ to } +14.64 \text{ psi} \\ -757 \text{ to } +757 \text{ mmHg} \\ -29.8 \text{ to } 29.8 \text{ inHg} \end{array} \right\}$	$\left\{ \begin{array}{l} -0.101 \text{ to } +1.010 \text{ MPa} \\ -101 \text{ to } +1,010 \text{ kPa} \\ -1.03 \text{ to } +10.30 \text{ kgf/cm}^2 \\ -1.01 \text{ to } +10.10 \text{ bar} \\ -14.6 \text{ to } +146.4 \text{ psi} \end{array} \right\}$	$\left\{ \begin{array}{l} -101.0 \text{ to } +101.0 \text{ kPa} \\ -1.030 \text{ to } +1.030 \text{ kgf/cm}^2 \\ -1.010 \text{ to } +1.010 \text{ bar} \\ -14.64 \text{ to } +14.64 \text{ psi} \\ -757 \text{ to } +757 \text{ mmHg} \\ -29.8 \text{ to } 29.8 \text{ inHg} \end{array} \right\}$	$\left\{ \begin{array}{l} -0.101 \text{ to } +1.010 \text{ MPa} \\ -101 \text{ to } +1,010 \text{ kPa} \\ -1.03 \text{ to } +10.30 \text{ kgf/cm}^2 \\ -1.01 \text{ to } +10.10 \text{ bar} \\ -14.6 \text{ to } +146.4 \text{ psi} \end{array} \right\}$
Indicator			Orange LED (Comparative output 1 operation indicator, comparative output 2 operation indicator: Lights up when each comparative output is ON)		Orange LED (Comparative output 1 operation indicator: Lights up when comparative output is ON, Analog voltage output operation indicator: Lights up when setting)	
Protection			IP40 (IEC)			
Ambient temperature			-10 to +50 °C +14 to +122 °F, Storage: -10 to +60 °C +14 to +140 °F			
Ambient humidity			35 to 85 % RH (No dew condensation or icing allowed), Storage: 35 to 85 % RH			
Voltage withstandability			1,000 V AC for one min. between all supply terminals connected together and enclosure			
Insulation resistance			50M Ω or more with 500 V DC megger between all supply terminals connected together and enclosure			
Vibration resistance			10 to 500 Hz frequency, 3 mm 0.118 in amplitude or maximum acceleration 196 m/s ² , in X, Y and Z directions for two hours each (when panel is mounted: 10 to 150 Hz frequency, 0.75 mm 0.030 in amplitude or maximum acceleration 49 m/s ² , in X, Y and Z directions for two hours each)			
Shock resistance			100 m/s ² acceleration (10 G approx.) in X, Y and Z directions for three times each			
Temperature characteristics			Within $\pm 0.5\%$ F.S. (at +20 °C +68 °F)	Within $\pm 1\%$ F.S. (at +20 °C +68 °F)	Within $\pm 0.5\%$ F.S. (at +20 °C +68 °F)	Within $\pm 1\%$ F.S. (at +20 °C +68 °F)
Pressure port			Asia: M5 female thread + R (PT) 1/8 male thread [excluding DP-□-M(-P)], Europe: M5 female thread + G 1/8 male thread, North America: M5 female thread + NPT 1/8 male thread			
Material			Enclosure: PBT (glass fiber reinforced), LCD display: Acrylic, Pressure port: Stainless steel (SUS303), Mounting threaded part: Brass (nickel plated), Switch part: Silicone rubber			
Connecting method / Cable length			Connector / Total length up to 100 m 328.084 ft (less than 30 m 98.425 ft when conforming to CE marking) is possible with 0.3 mm ² , or more, cable			
Weight			Net weight: 40 g approx. (DP-10□-M(-P): 30 g approx.), Gross weight: 130 g approx. (DP-10□-M(-P): 120 g approx.)			
Accessories			CN-14A-C2 (Connector attached cable 2 m 6.562 ft): 1pc. (excluding M8 plug-in connector type)			

- Notes: 1) Where measurement conditions have not been specified precisely, the conditions used were an ambient temperature of +20 °C +68 °F.
2) Model Nos. of Asia type having "-M" are short pressure port type. Model Nos. of Asia and North America types having the suffix "-P" are PNP output type.
3) Only standard type is equipped with comparative output 2.
4) Cannot be used at the same time.

FIBER SENSORS

LASER SENSORS

PHOTO-ELECTRIC SENSORS

MICRO PHOTO-ELECTRIC SENSORS

AREA SENSORS

LIGHT CURTAINS / SAFETY COMPONENTS

PRESSURE / FLOW SENSORS

INDUCTIVE PROXIMITY SENSORS

PARTICULAR USE SENSORS

SENSOR OPTIONS

SIMPLE WIRE-SAVING UNITS

WIRE-SAVING SYSTEMS

MEASUREMENT SENSORS

STATIC ELECTRICITY PREVENTION DEVICES

LASER MARKERS

PLC

HUMAN MACHINE INTERFACES

ENERGY CONSUMPTION VISUALIZATION COMPONENTS

FA COMPONENTS

MACHINE VISION SYSTEMS

UV CURING SYSTEMS

Selection Guide

Pressure/Digital Display

Pressure/Head-separated

Flow

DP-100

DP-M

I/O CIRCUIT AND WIRING DIAGRAMS

FIBER SENSORS
LASER SENSORS
PHOTO-ELECTRIC SENSORS
MICRO PHOTO-ELECTRIC SENSORS
AREA SENSORS
LIGHT CURTAINS/ SAFETY COMPONENTS
PRESSURE/ FLOW SENSORS
INDUCTIVE PROXIMITY SENSORS
PARTICULAR USE SENSORS
SENSOR OPTIONS
SIMPLE WIRE-SAVING UNITS
WIRE-SAVING SYSTEMS
MEASUREMENT SENSORS
STATIC ELECTRICITY PREVENTION DEVICES
LASER MARKERS
PLC
HUMAN MACHINE INTERFACES
ENERGY CONSUMPTION VISUALIZATION COMPONENTS
FA COMPONENTS
MACHINE VISION SYSTEMS
UV CURING SYSTEMS
Selection Guide
Pressure/ Digital Display
Pressure/ Head-separated
Flow
DP-100
DP-M

DP-10□

NPN output type

I/O circuit diagram

Standard type

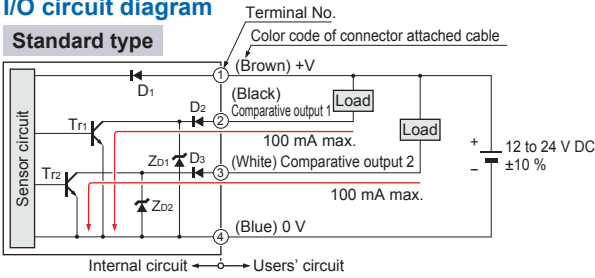

Symbols... D1 to D3 : Reverse supply polarity protection diode
Zd1, Zd2 : Surge absorption zener diode
Tr1, Tr2 : NPN output transistor

Multi-function type

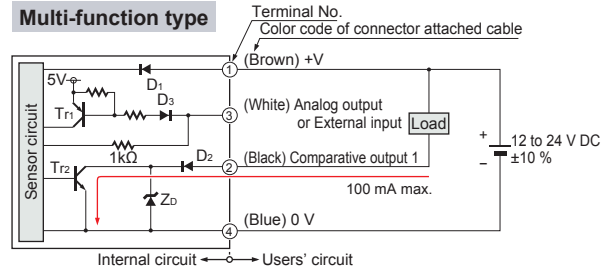

Symbols... D1 to D3 : Reverse supply polarity protection diode
Zd : Surge absorption zener diode
Tr1 : PNP input transistor
Tr2 : NPN output transistor

Terminal arrangement diagram

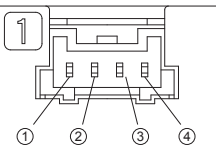

Terminal	Designation
①	+V
②	Comparative output 1
③	Standard type: Comparative output 2 Multi-function type: Analog output or External input
④	0 V

DP-10□-P

PNP output type

I/O circuit diagram

Standard type

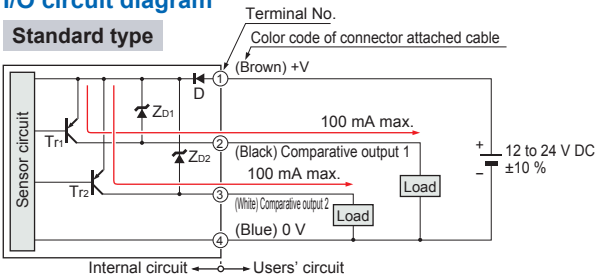

Symbols... D : Reverse supply polarity protection diode
Zd1, Zd2 : Surge absorption zener diode
Tr1, Tr2 : PNP output transistor

Multi-function type

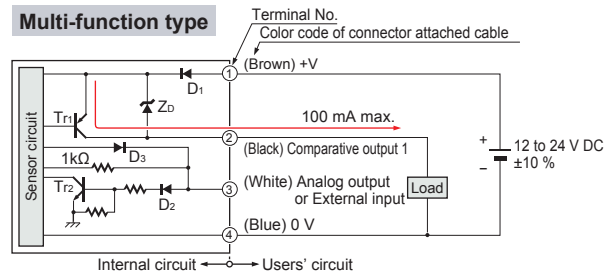

Symbols... D1, D2 : Reverse supply polarity protection diode
Zd : Surge absorption zener diode
Tr1 : PNP output transistor
Tr2 : NPN input transistor

Terminal arrangement diagram

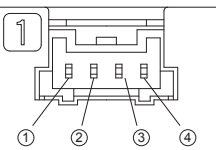

Terminal	Designation
①	+V
②	Comparative output 1
③	Standard type: Comparative output 2 Multi-function type: Analog output or External input
④	0 V

DP-11□-E-P-J

PNP output type

I/O circuit diagram

Standard type

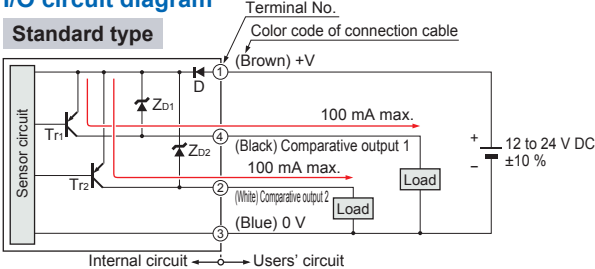

Symbols... D : Reverse supply polarity protection diode
Zd1, Zd2 : Surge absorption zener diode
Tr1, Tr2 : PNP output transistor

Multi-function type

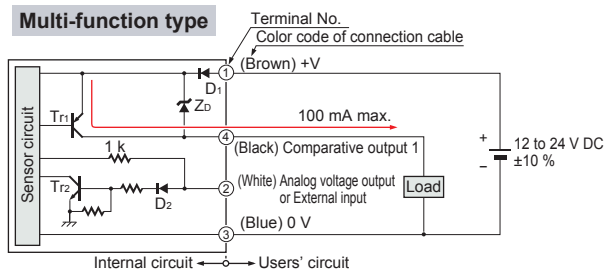

Symbols... D1, D2 : Reverse supply polarity protection diode
Zd : Surge absorption zener diode
Tr1 : PNP output transistor
Tr2 : NPN input transistor

Terminal arrangement diagram

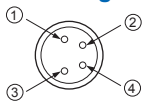

Terminal	Designation
①	+V
②	Standard type: Comparative output 2 Multi-function type: Analog output or External input
③	0 V
④	Comparative output 1

PRECAUTIONS FOR PROPER USE

Refer to p.1472 for general precautions.

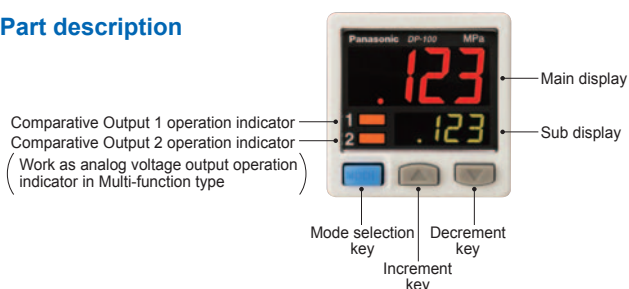

- Never use this product as a sensing device for personnel protection.
- In case of using sensing devices for personnel protection, use products which meet laws and standards, such as OSHA, ANSI or IEC etc., for personnel protection applicable in each region or country.
- The DP-100 series is designed for use with non-corrosive gas. It cannot be used with liquid or corrosive gas.

Part description**Wiring**

- Make sure that the power supply is off while wiring.
- Verify that the supply voltage variation is within the rating.
- If power is supplied from a commercial switching regulator, ensure that the frame ground (F.G.) terminal of the power supply is connected to an actual ground.
- In case noise generating equipment (switching regulator, inverter motor, etc.) is used in the vicinity of this sensor, connect the frame ground (F.G.) terminal of the equipment to an actual ground.
- Do not run the wires together with high-voltage lines or power lines or put them in the same raceway. This can cause malfunction due to induction.
- Incorrect wiring will cause problems with operation.

Connection

- Do not apply stress directly to the connection cable leader or to the connector.

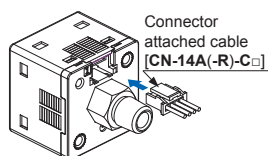
**Mounting**

- **MS-DP1-1 / MS-DP1-5** sensor mounting brackets are available separately, and it should be used for mounting. When tightening the sensor to the sensor mounting bracket, use a tightening torque of 0.5 N·m or less.

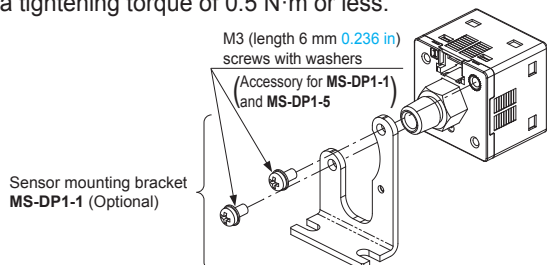

- The **MS-DP1-2** panel mounting bracket (optional) and the **MS-DP1-3** front protection cover (optional) are also available.

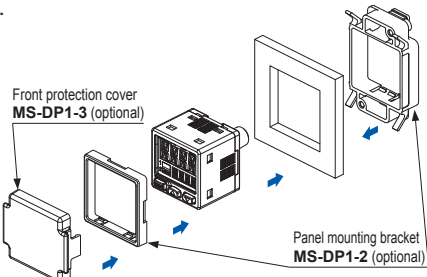

- The **MS-DP1-4** panel mounting bracket is available when switching from the **DP2 / DP3** series.

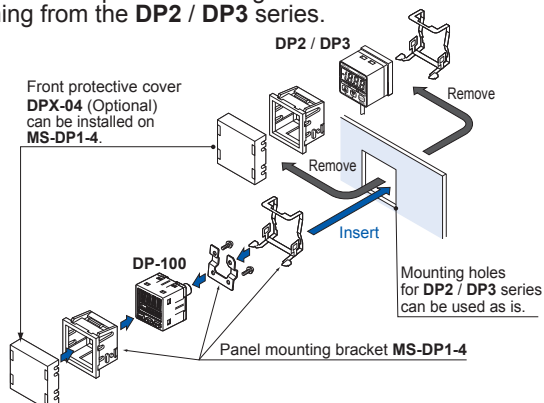

- An conversion bushing is available for when using the **DP-10□-M** short pressure port type. It can be used to switch between this model and the **DP2 / DP3** series. When connecting to the pressure port, use a tightening torque of 1.0 N·m or less.

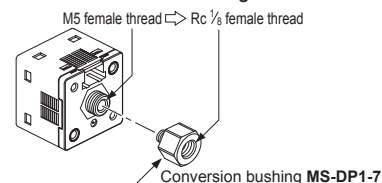

- The **MS-DP1-F** flat attachment is available. If using the **MS-DP1-F** flat attachment (optional), install by following the procedures given below.

- Decide the direction of this product to mount with the sensor.

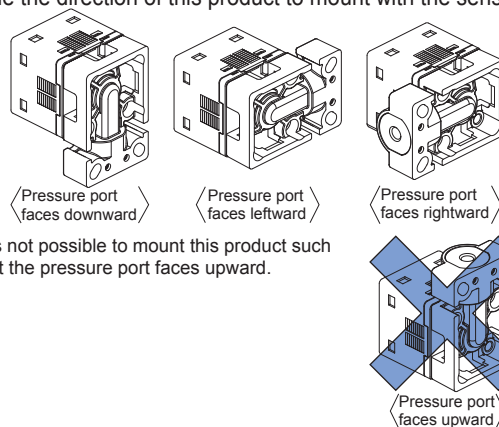

- Mount this product with the M3 female threads of the sensor by using the attached M3 (length 8 mm 0.315 in) screws. The tightening torque should be 0.5 N·m or less.

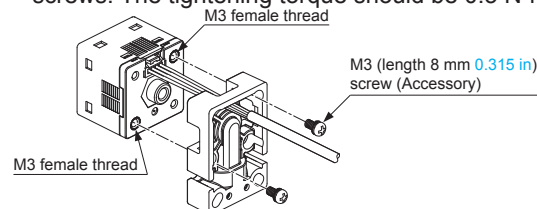

- Mount this product with the mounting surface by using the attached M4 (length 20 mm 0.787 in) screws. The tightening torque should be 1.2 N·m or less.

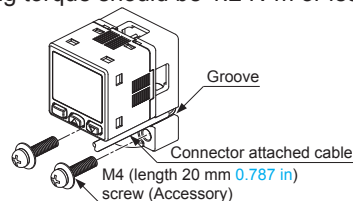

- Note: Take care that if the cable with connector is sticking out of the side groove of this product when mounting, the cable may disconnected.

FIBER SENSORS

LASER SENSORS

PHOTO-ELECTRIC SENSORS

MICRO PHOTO-ELECTRIC SENSORS

AREA SENSORS

LIGHT CURTAINS / SAFETY COMPONENTS

PRESSURE / FLOW SENSORS

INDUCTIVE PROXIMITY SENSORS

PARTICULAR USE SENSORS

SENSOR OPTIONS

SIMPLE WIRE-SAVING UNITS

WIRE-SAVING SYSTEMS

MEASUREMENT SENSORS

STATIC ELECTRICITY PREVENTION DEVICES

LASER MARKERS

PLC

HUMAN MACHINE INTERFACES

ENERGY CONSUMPTION VISUALIZATION COMPONENTS

FA COMPONENTS

MACHINE VISION SYSTEMS

UV CURING SYSTEMS

Selection Guide

Pressure/ Digital Display

Pressure/ Head-separated

Flow

DP-100

DP-M

PRECAUTIONS FOR PROPER USE

Refer to p.1472 for general precautions.

Conditions in use for CE conformity

- The **DP-100** series is a CE conformity product complying with EMC Directive. The harmonized standard with regard to immunity that applies to this product is EN 61000-6-2 and the following condition must be met to conform to that standard.

Condition

- The line to connect with this sensor should be less than 30 m 98.425 ft.

Piping

- If connecting a commercially-available coupling to the pressure port, attach a 12 mm 0.472 in spanner (14 mm 0.551 in spanner for **DP-100-E** type) to the hexagonal section of the pressure port to secure it, and tighten at a torque of 9.8 N·m or less. If it is tightened using excessive torque, it may damage the coupling or the pressure port. In addition, wrap sealing tape around the coupling when connecting it to prevent leaks.
- If connecting a commercially-available joint to the pressure port of the **DP-10□-M**, hold the main unit in your hand to steady it, and tighten to a torque of 1.0 N·m or less. If it is tightened to an excessive torque, the joint or the main unit may become damaged.
- If connecting a commercially-available joint to the pressure port of the **MS-DP1-7**, tighten to a torque of 9.8 N·m or less.

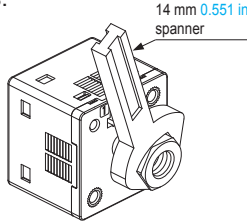
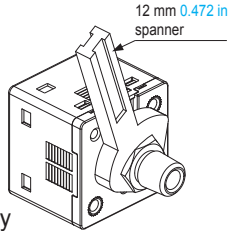

- The tightening torque should be 1 N·m or less when connecting a coupling to the pressure port of **MS-DP1-FM**.

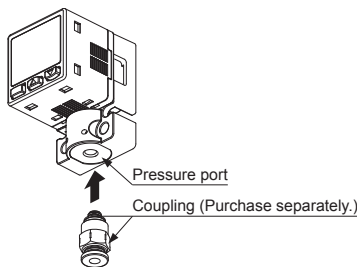

- When connecting the coupling to the pressure port of **MS-DP1-FR/FE/FN**, hold the pressure port with a 14 mm 0.551 in spanner and make sure that the tightening torque is 9.8 N·m or less. In addition, in order to prevent any leakage, wind a sealing tape on the coupling when connecting.

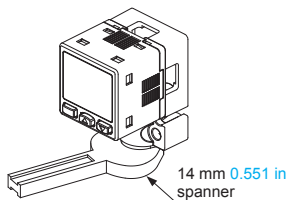

Note: Do not tighten the pressure port by holding the product with the spanner. It may cause the product breakage.

Flat attachment

- Make sure to mount **MS-DP1-F□** with the sensor properly. If it is not mounted properly, air leakage may occur.
- Take care that the excessive mounting and dismounting of this product may cause deterioration of the O-ring.
- If you touch the O-ring of **MS-DP1-F□**, or any scratch or dust, etc. is attached to it, air leakage may occur and the sensing performance may deteriorate. Take sufficient care when using and storing **MS-DP1-F□**.

Others

- Use within the rated pressure range.
- Do not apply pressure exceeding the pressure withstandability value. The diaphragm will get damaged and correct operation shall not be maintained.
- Do not use during the initial transient time (0.5 sec. approx.) after the power supply is switched on.
- Avoid dust, dirt, and steam.
- Take care that the sensor does not come in direct contact with water, oil, grease, or organic solvents, such as, thinner, etc.
- Do not insert wires, etc., into the pressure port. The diaphragm will get damaged and correct operation shall not be maintained.
- Do not operate the keys with pointed or sharp objects.

RUN mode

- This is the normal operating mode.

Setting item	Description
Threshold value setting	The threshold values for ON / OFF operation can be changed directly by pressing the increment key (UP) and the decrement key (DOWN).
Zero-adjustment function	This forces the pressure value display to be reset to zero when the pressure port is open on the atmospheric pressure side.
Key lock function	Stops key operations from being accepted.
Peak hold / bottom hold function	Displays the peak value and bottom value for fluctuating pressure. The peak value appears in the main display, and the bottom value appears in the sub display.

MENU SETTING mode

- If the mode selection key is pressed and held for 2 seconds in RUN mode, the mode will switch to MENU SETTING mode.
- If the mode selection key is pressed while a setting is being made, the mode will switch to RUN mode. In this case, the settings that have been changed will be entered.

Setting item	Description
Comparative output 1 output mode setting	Sets the output mode for comparative output 1.
Comparative output 2 output mode setting (standard type only)	Sets the output mode for comparative output 2.
Analog output / external input switching (multi-function type only)	Allows switching between analog voltage output / analog current output, and auto-reference input / remote zero-adjustment input.
NO / NC switching	Sets normally open (NO) or normally closed (NC).
Response time setting	Sets the response time. The response time can be selected from 2.5 ms, 5 ms, 10 ms, 25 ms, 50 ms, 100 ms, 250 ms, 500 ms, 1,000 ms and 5,000 ms.
Display color switching for main display	Allows the color for the main display to be changed. The colors can be set to 'red / green' or 'green / red' to correspond to ON / OFF output, or it can be fixed at 'red' or 'green' all the time.
Unit switching	Pressure unit can be changed.

PRECAUTIONS FOR PROPER USE

Refer to p.1472 for general precautions.

PRO mode

- If the mode selection key is pressed and held for 5 seconds in RUN mode, the mode will switch to PRO mode.
- If the mode selection key is pressed while a setting is being made, the mode will switch to RUN mode. In this case, the settings that have been changed will be entered.

Setting item	Description
Sub display switching	Changes the information in the sub display during RUN mode operation to the desired alphanumeric display.
Display refresh rate switching	Changes the display refresh rate for the pressure value displayed in the main display.
Hysteresis fix value switching	Sets the hysteresis for EASY mode and window comparator mode. (8 steps)
Linked display color switching (standard type only)	Allows the display color for the main display to be switched in line with the output operation for comparative output 1 or comparative output 2.
ECO mode setting	Allows power consumption to be reduced by dimming the display or turning it off.
Setting check code	Allows the setting details to be checked via codes.
Setting copy mode	Allows the setting details for the master sensor to be copied to slave sensors.
Reset setting	Resets the settings to the factory settings.

Table of codes

Code	1st digit		2nd digit		3rd digit	4th digit	
	Comparative output 1 output mode	NO / NC switching	Comparative output 2 output mode	NO / NC switching		Standard type	Multi-function type
0	EASY	NO	OFF	OFF	P-1, Lo-1	Analog voltage output	Red when ON
1		NC	EASY	NO			Auto-reference
2	Hysteresis	NO		NC	NC	P-2, Lo-2	Remote zero-adjustment
3		NC	NO	Analog current output	Hi-2		
4	Window comparator	NO	Hysteresis	NC	ADJ.	—	Always red
5		NC		NO			—
6	—	—	Window comparator	NC	—	—	Always green
7	—	—	—	—	—	—	Comparative output 1
							Comparative output 2

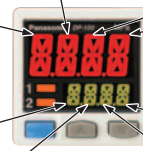

Code	5th digit	6th digit	7th digit	8th digit
	Response time	Unit switching	Display refresh rate	ECO mode
0	2.5 ms	MPa	250 ms	OFF
1	5 ms	kPa	500 ms	STD
2	10 ms	kgf/cm ²	1,000 ms	FULL
3	25 ms	bar	—	—
4	50 ms	psi	—	—
5	100 ms	mmHg	—	—
6	250 ms	inchHg	—	—
7	500 ms	—	—	—
8	1,000 ms	—	—	—
9	5,000 ms	—	—	—

DIMENSIONS (Unit: mm in)

The CAD data in the dimensions can be downloaded from the website.

DP-10 Sensor

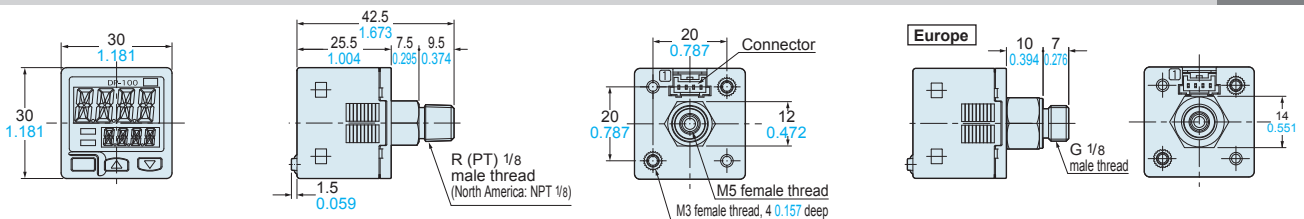

DP-10-M(P) Sensor

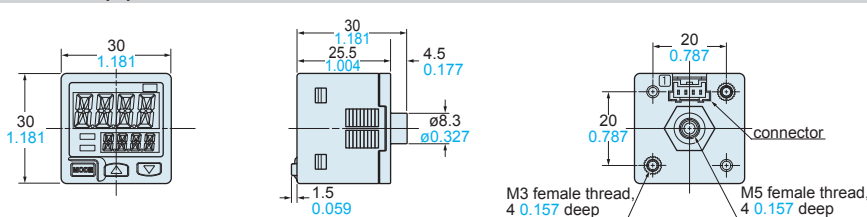

DP-11-E-P-J Sensor

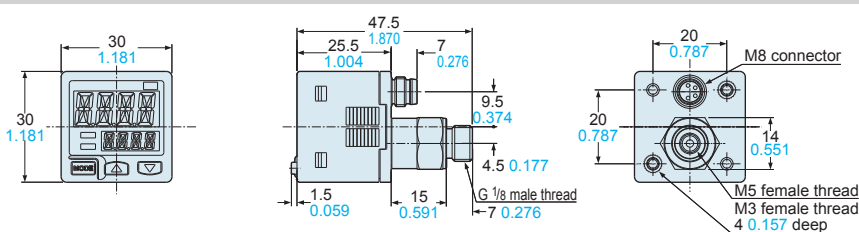

FIBER SENSORS
LASER SENSORS
PHOTO-ELECTRIC SENSORS
MICRO PHOTO-ELECTRIC SENSORS
AREA SENSORS
LIGHT CURTAINS / SAFETY COMPONENTS
PRESSURE / FLOW SENSORS
INDUCTIVE PROXIMITY SENSORS
PARTICULAR USE SENSORS
SENSOR OPTIONS
SIMPLE WIRE-SAVING UNITS
WIRE-SAVING SYSTEMS
MEASUREMENT SENSORS
STATIC ELECTRICITY PREVENTION DEVICES
LASER MARKERS
PLC
HUMAN MACHINE INTERFACES
ENERGY CONSUMPTION VISUALIZATION COMPONENTS
FA COMPONENTS
MACHINE VISION SYSTEMS
UV CURING SYSTEMS

Selection Guide
Pressure/ Digital Display
Pressure/ Head-separated
Flow

DP-100
DP-M

- FIBER SENSORS
- LASER SENSORS
- PHOTO-ELECTRIC SENSORS
- MICRO PHOTO-ELECTRIC SENSORS
- AREA SENSORS
- LIGHT CURTAINS/ SAFETY COMPONENTS
- PRESSURE/ FLOW SENSORS
- INDUCTIVE PROXIMITY SENSORS
- PARTICULAR USE SENSORS
- SENSOR OPTIONS
- SIMPLE WIRE-SAVING UNITS
- WIRE-SAVING SYSTEMS
- MEASUREMENT SENSORS
- STATIC ELECTRICITY PREVENTION DEVICES
- LASER MARKERS
- PLC
- HUMAN MACHINE INTERFACES
- ENERGY CONSUMPTION VISUALIZATION COMPONENTS
- FA COMPONENTS
- MACHINE VISION SYSTEMS
- UV CURING SYSTEMS

DIMENSIONS (Unit: mm in)

The CAD data in the dimensions can be downloaded from the website.

MS-DP1-1

Sensor mounting bracket (Optional)

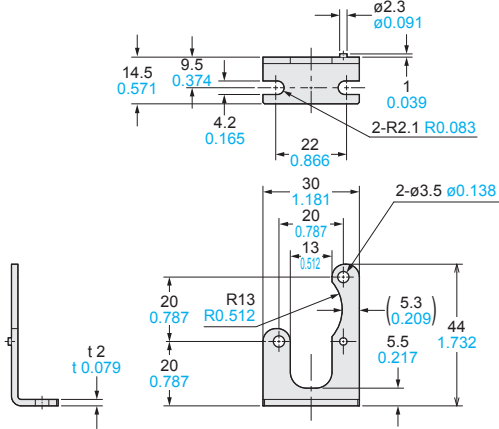

Material: Cold rolled carbon steel (SPCC) (Uni-chrome plated)
Two M3 (length 6 mm 0.236 in) screws with washers are attached.

Assembly dimensions
Mounting drawing with DP-10□

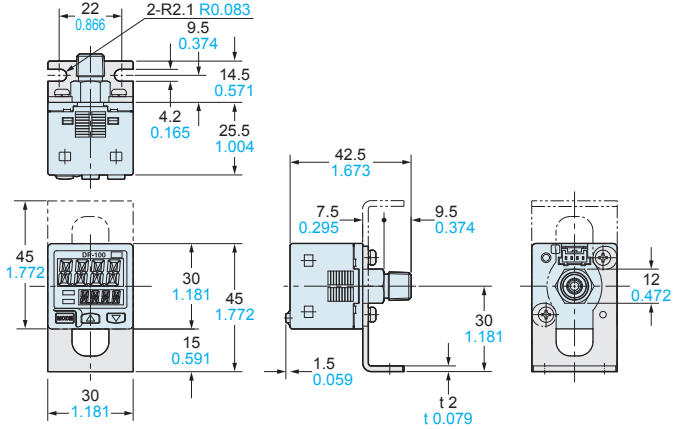

MS-DP1-5

Sensor mounting bracket (Optional)

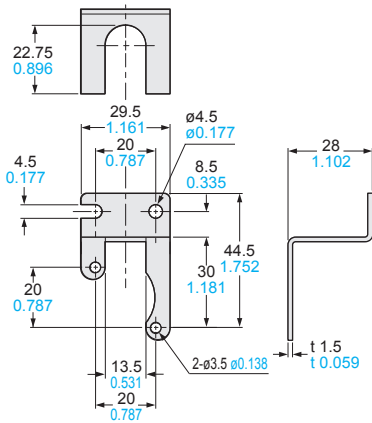

Material: Cold rolled carbon steel (SPCC) (Uni-chrome plated)
Two M3 (length 6 mm 0.236 in) screws with washers are attached.

Assembly dimensions
Mounting drawing with DP-10□-M

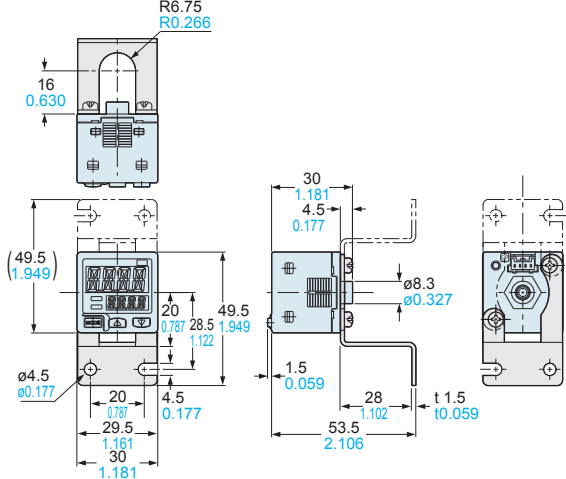

MS-DP1-2 MS-DP1-3

Panel mounting bracket (Optional), Front protection cover (Optional)

Assembly dimensions
Mounting drawing with DP-10□

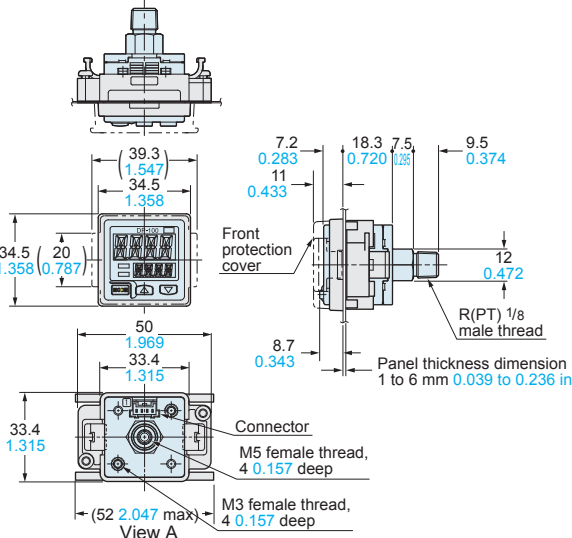

Material: POM (Panel mounting bracket)
Polycarbonate (Front protection cover)

Panel cut-out dimensions

When 1 unit is installed

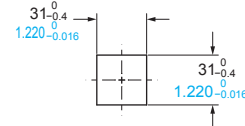

When "n" units are installed horizontally in series

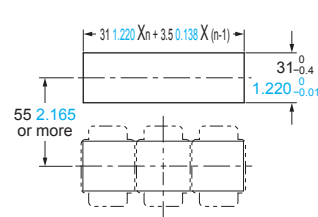

When "n" units are installed vertically in series

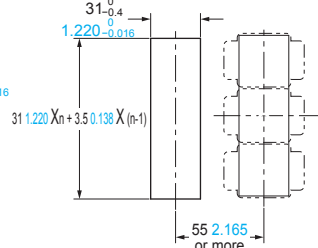

Note: The panel thickness should be 1 to 6 mm 0.039 to 0.236 in.

Note: The panel thickness should be 1 to 6 mm 0.039 to 0.236 in.

- Selection Guide
- Pressure/ Digital Display
- Pressure/ Head-separated
- Flow
- DP-100
- DP-M

DIMENSIONS (Unit: mm in)

The CAD data in the dimensions can be downloaded from the website.

MS-DP1-4

Panel mounting bracket (Optional)

Assembly dimensions

Mounting drawing with **DP-10**

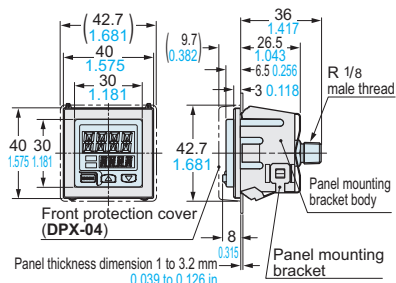

Panel cut-out dimensions

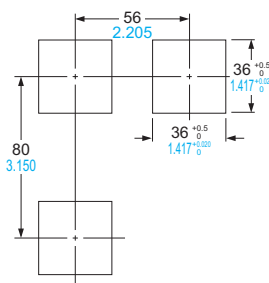

Note: The panel thickness should be 1 to 32 mm 0.039 to 1.260 in.

Material: Panel mounting bracket body ... Nylon 6
Panel mounting bracket ... Stainless steel (SUS304)
Spacer ... Cold rolled carbon steel (SPCC)(Uni-chrome plated)

MS-DP1-FM

Flat attachment (Optional)

Assembly dimensions

Mounting drawing with **DP-10-M**

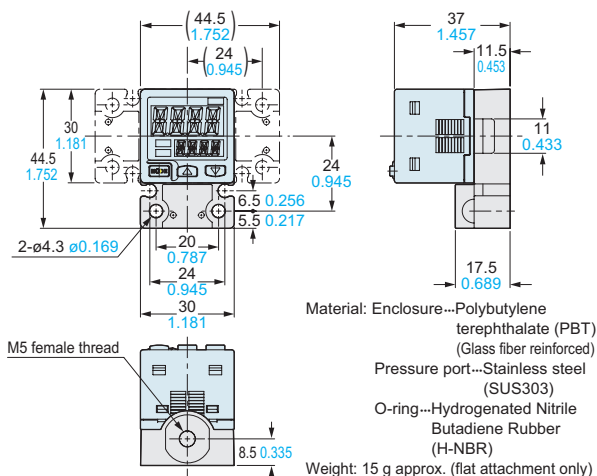

Material: Enclosure...Polybutylene terephthalate (PBT) (Glass fiber reinforced)
Pressure port--Stainless steel (SUS303)
O-ring--Hydrogenated Nitrile Butadiene Rubber (H-NBR)
Weight: 15 g approx. (flat attachment only)

Two M3 (length 8 mm 0.315 in) screws, two M4 (length 20 mm 0.787 in) screws are attached.

MS-DP1-FR/FN/FE

Flat attachment (Optional)

Assembly dimensions

Mounting drawing with **DP-10-M**

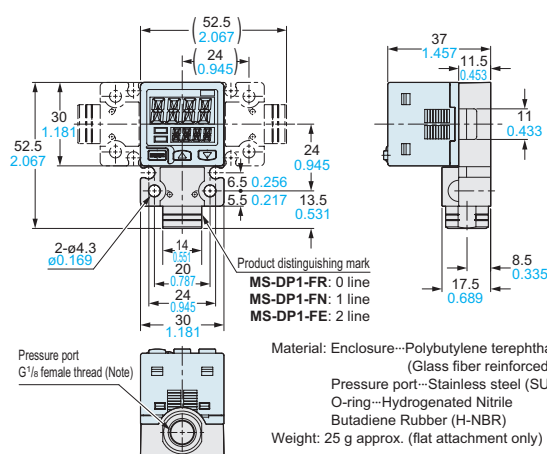

Material: Enclosure...Polybutylene terephthalate (PBT) (Glass fiber reinforced)
Pressure port--Stainless steel (SUS303)
O-ring--Hydrogenated Nitrile Butadiene Rubber (H-NBR)
Weight: 25 g approx. (flat attachment only)

Two M3 (length 8 mm 0.315 in) screws, two M4 (length 20 mm 0.787 in) screws are attached.

Note: **MS-DP1-FR** has a Rc1/8 female thread.
MS-DP1-FN has a NPT 1/8 female thread.

MS-DP1-7

Conversion bushing (Optional)

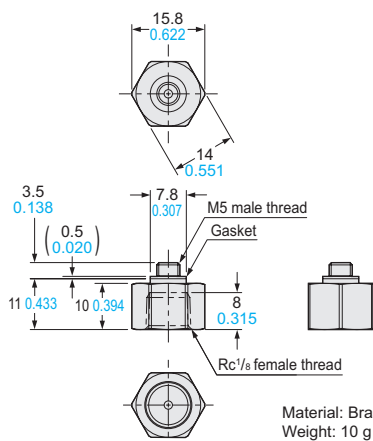

Material: Brass (Nickel plated)
Weight: 10 g approx.

CN-14A(-R)-C

Connector attached cable (Optional, CN-14A-C2 is attached to the sensor)

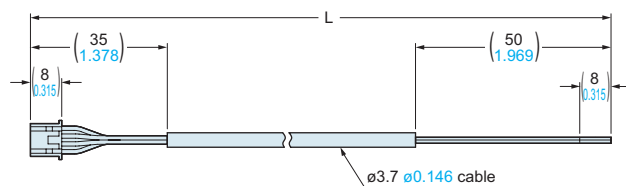

• Length L

Model No.	Length L (mm in)
CN-14A(-R)-C1	1,000 39.370
CN-14A(-R)-C2	2,000 78.740
CN-14A(-R)-C3	3,000 118.110
CN-14A(-R)-C5	5,000 196.850

FIBER SENSORS

LASER SENSORS

PHOTO-ELECTRIC SENSORS

MICRO PHOTO-ELECTRIC SENSORS

AREA SENSORS

LIGHT CURTAINS / SAFETY COMPONENTS

PRESSURE / FLOW SENSORS

INDUCTIVE PROXIMITY SENSORS

PARTICULAR USE SENSORS

SENSOR OPTIONS

WIRE- SAVING UNITS

WIRE- SAVING SYSTEMS

MEASUREMENT SENSORS

STATIC ELECTRICITY PREVENTION DEVICES

LASER MARKERS

PLC

HUMAN MACHINE INTERFACES

ENERGY CONSUMPTION VISUALIZATION COMPONENTS

FA COMPONENTS

MACHINE VISION SYSTEMS

UV CURING SYSTEMS

Selection Guide

Pressure/ Digital Display

Pressure/ Head-separated

Flow

DP-100

DP-M