



Chipsmall Limited consists of a professional team with an average of over 10 year of expertise in the distribution of electronic components. Based in Hongkong, we have already established firm and mutual-benefit business relationships with customers from,Europe,America and south Asia,supplying obsolete and hard-to-find components to meet their specific needs.

With the principle of “Quality Parts,Customers Priority,Honest Operation,and Considerate Service”,our business mainly focus on the distribution of electronic components. Line cards we deal with include Microchip,ALPS,ROHM,Xilinx,Pulse,ON,Everlight and Freescale. Main products comprise IC,Modules,Potentiometer,IC Socket,Relay,Connector.Our parts cover such applications as commercial,industrial, and automotives areas.

We are looking forward to setting up business relationship with you and hope to provide you with the best service and solution. Let us make a better world for our industry!



Contact us

Tel: +86-755-8981 8866 Fax: +86-755-8427 6832

Email & Skype: info@chipsmall.com Web: www.chipsmall.com

Address: A1208, Overseas Decoration Building, #122 Zhenhua RD., Futian, Shenzhen, China





opulent
americas

MOD BLOCK - 2X2 Standard

IP67-Rated Module built with Cree XHP50.2 LEDs

Primary Applications



High Mast
Streetlight
Stadium
Architectural

Canopy
Garage
Portable
High bay

Features and Benefits

- IP67 Protection – Self-contained module for outdoor applications or other difficult environments
- Optical Flexibility – a variety of off-the-shelf optical patterns are available; built with LEDiL optics.
- Integrate Further – Easy to add multiple modules through our interlocking technology
- Easy Mounting – designed for quick mounting to a housing or bracket
- Performance – industry leading lumen density and lumens per pound
- Certifications – RoHS compliant
- Custom - private label or design changes available

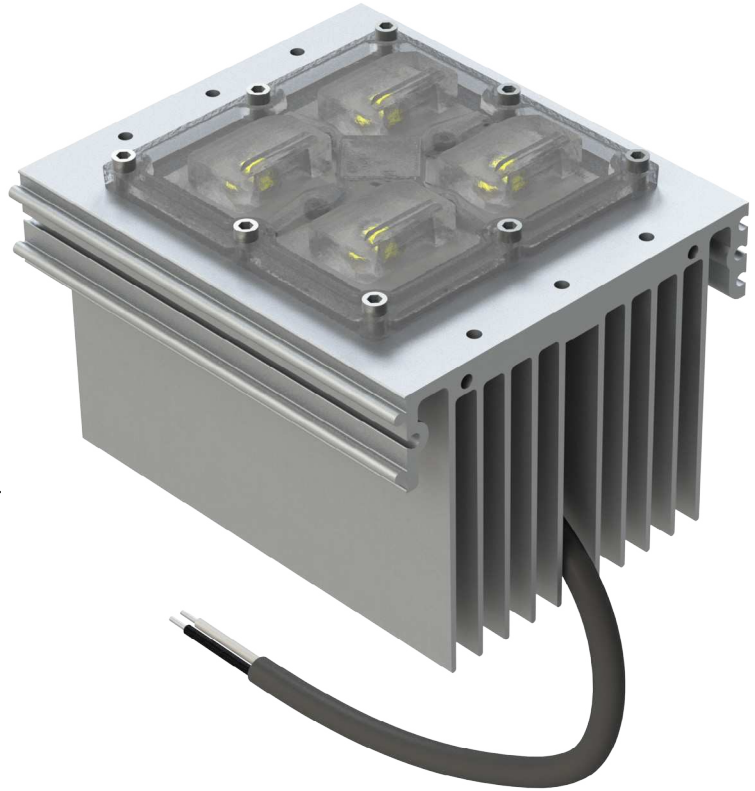

Introducing the Opulent Americas IP67 rated LED heat sink module using Cree XHP50.2 Extreme High Power LEDs. This Opulent Americas module is engineered to bring high quality lighting systems to market faster with fewer LEDs, higher reliability, and a lower system cost. This module is a robust, flexible, and versatile building block for any number of lighting systems such as high bay, low bay, parking, and stadium lighting.

Interlocking Technology to Add More Modules

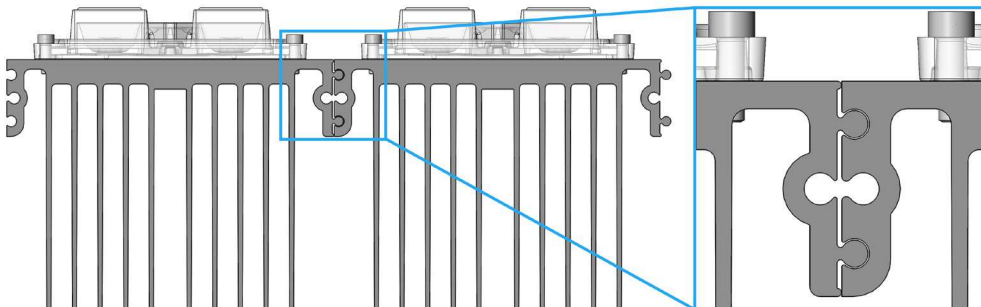

Last Modified: 11/16/17

RoHS

MOD BLOCK - 2X2 Standard Specifications

Order Code Formatting

| Series | - | Color Temperature | Color Rendering Index | - | Optic | - | Cable Type | - | Internal Code |
|---------------------------------|---|-------------------|-----------------------|---|-------|---|--------------------------|---|---------------|
| MS22T1 -C22 - XHP50.2 Mod Block | | 27 - 2700K | 70 - 70 CRI | | M | | 1 - Cable Pigtail | | XX |
| | | 30 - 3000K | 80 - 80 CRI | | W | | 2 - Waterproof M15 Cable | | |
| | | 40 - 4000K | 90 - 90 CRI | | WWW | | | | |
| | | 50 - 5000K | | | T2 | | | | |
| | | 57 - 5700K | | | T4 | | | | |
| | | | | | T5 | | | | |
| | | | | | DWC | | | | |

*See Page 5
for Photometric
Distributions

MOD BLOCK - 2X2 Standard Specifications

Ordering Information

| Part Number | CCT | CRI | Binning | Forward Voltage (V) | Current (mA) | Typical Luminous Flux (lm) | Efficacy Nominal (lm/W) | Watts (W) |
|--------------------|-------|-----|---------|---------------------|--------------|----------------------------|-------------------------|-----------|
| MS22T1 -C22-5770-x | 5700K | 70 | ANSI | 45.5 | 700 | 4500 | 141 | 32 |
| | 5700K | 70 | ANSI | 45.8 | 1050 | 6030 | 125 | 48 |
| | 5700K | 70 | ANSI | 46.1 | 1500 | 7500 | 109 | 69 |
| MS22T1 -C22-5070-x | 5000K | 70 | 5-Step | 45.5 | 700 | 4500 | 141 | 32 |
| | 5000K | 70 | 5-Step | 45.8 | 1050 | 6030 | 125 | 48 |
| | 5000K | 70 | 5-Step | 46.1 | 1500 | 7500 | 109 | 69 |
| MS22T1 -C22-4070-x | 4000K | 70 | 5-Step | 45.5 | 700 | 4500 | 141 | 32 |
| | 4000K | 70 | 5-Step | 45.8 | 1050 | 6030 | 125 | 48 |
| | 4000K | 70 | 5-Step | 46.1 | 1500 | 7500 | 109 | 69 |

Product performance based on 25°C ambient temperature.
All values shown above are typical.

Ratings

| Parameter | Unit | Rating |
|-----------------------|------|------------|
| Operating Temperature | °C | -40 to +40 |
| Weight | G | 865 |

Performance Groups – Chromaticity

| Binning | CCT | X | Y |
|---------|-------|--------|--------|
| ANSI | 5700K | 0.3207 | 0.3462 |
| | | 0.3376 | 0.3616 |
| | | 0.3366 | 0.3369 |
| | | 0.3222 | 0.3243 |

| Binning | CCT | Center Point | | Major Axis | | Rotation Angle (°) |
|---------|-------|--------------|--------|------------|---------|--------------------|
| | | X | Y | a | b | |
| 5-Step | 5000K | 0.3447 | 0.3553 | 0.01400 | 0.00520 | 65.0 |
| 5-Step | 4000K | 0.3818 | 0.3797 | 0.001420 | 0.00550 | 61.5 |

MOD BLOCK - 2X2 Standard Specifications

Performance Characteristics

Lumens vs Drive Current

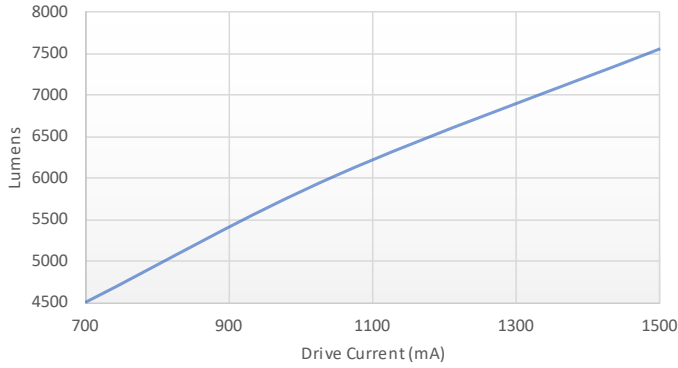

Tsp vs Drive Current

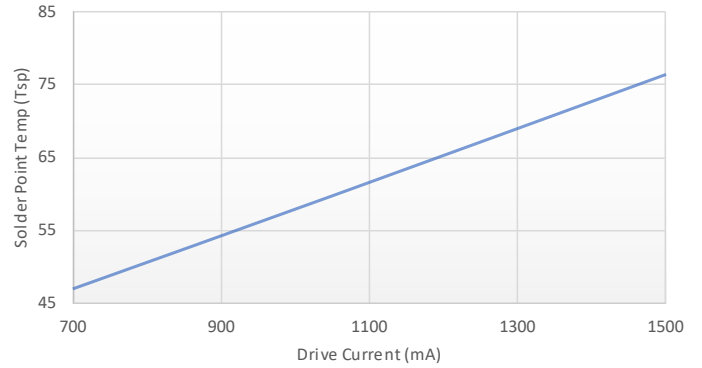

Efficacy vs Drive Current

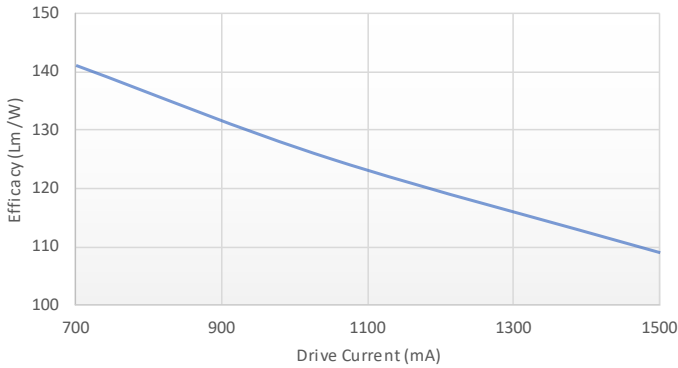

Tsp vs Lumens

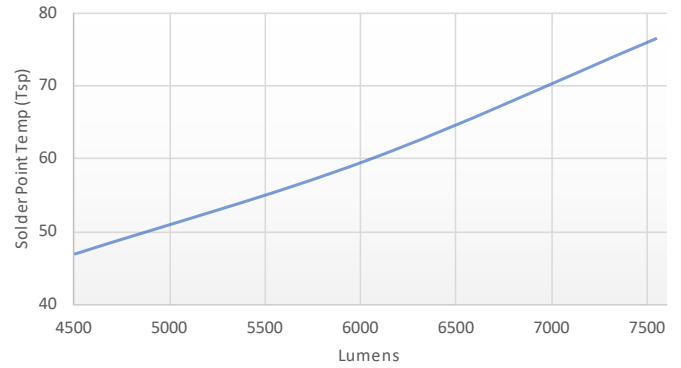

Power vs Drive Current

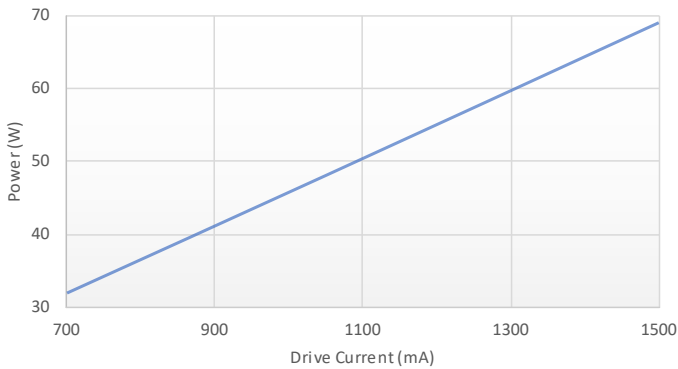

*Product performance based on 25°C ambient temperature

MOD BLOCK - 2X2 Standard Specifications

Photometric Distributions

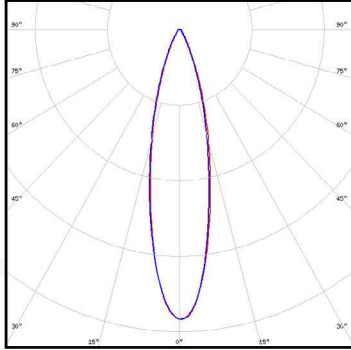

M - Medium
High Bay Series

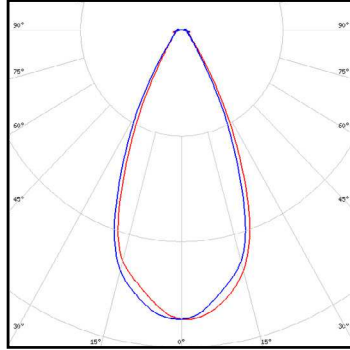

W - Wide
High Bay Series

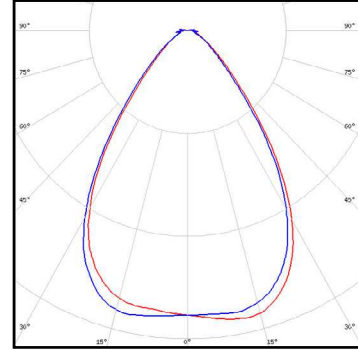

WWW - Very Wide
High Bay Series

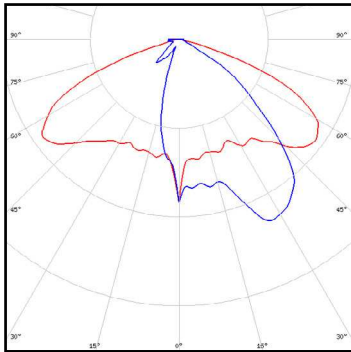

T2 - IESNA Type II
Roadway Series

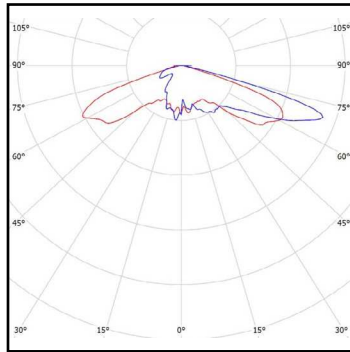

T4 - IESNA Type IV
Roadway Series

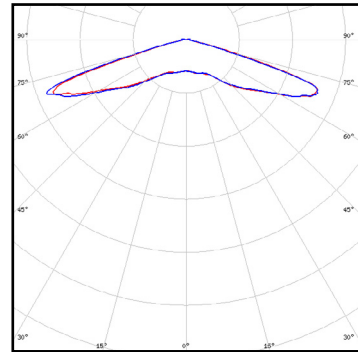

T5 - IESNA Type V Square
Roadway Series

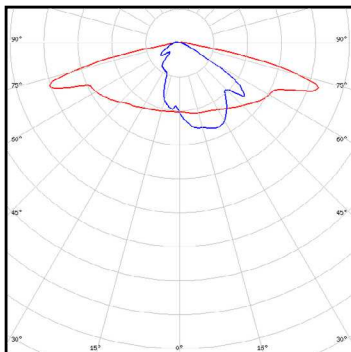

DWC - Universal Type III Medium
Roadway Series

*Photometric distributions made with LEDiL optics

MOD BLOCK - 2X2 Standard Specifications

Mechanical Dimensions

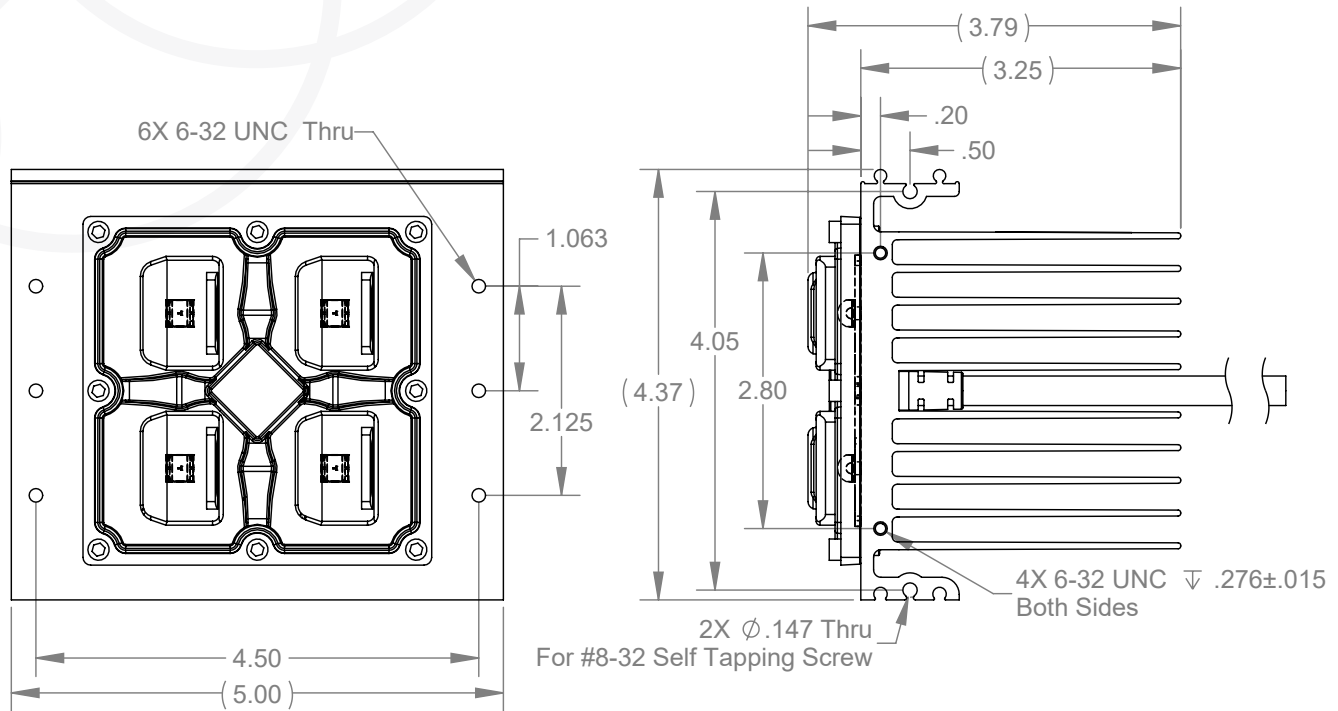

Cable Specs:

Cable Length: 20"

Cable OD: .288"

Wire Gauge: 18AWG

Wire Colors: White (+), Black (-)

Wire Voltage Rating: 300V

Wire Temperature Rating: 105°C