



Chipsmall Limited consists of a professional team with an average of over 10 year of expertise in the distribution of electronic components. Based in Hongkong, we have already established firm and mutual-benefit business relationships with customers from,Europe,America and south Asia,supplying obsolete and hard-to-find components to meet their specific needs.

With the principle of “Quality Parts,Customers Priority,Honest Operation,and Considerate Service”,our business mainly focus on the distribution of electronic components. Line cards we deal with include Microchip,ALPS,ROHM,Xilinx,Pulse,ON,Everlight and Freescale. Main products comprise IC,Modules,Potentiometer,IC Socket,Relay,Connector.Our parts cover such applications as commercial,industrial, and automotives areas.

We are looking forward to setting up business relationship with you and hope to provide you with the best service and solution. Let us make a better world for our industry!



Contact us

Tel: +86-755-8981 8866 Fax: +86-755-8427 6832

Email & Skype: info@chipsmall.com Web: www.chipsmall.com

Address: A1208, Overseas Decoration Building, #122 Zhenhua RD., Futian, Shenzhen, China



Data Sheet

Description

The MSA-1110 is a high performance silicon bipolar Monolithic Microwave Integrated Circuit (MMIC) housed in a hermetic high reliability package. This MMIC is designed for high dynamic range in either 50 or 75Ω systems by combining low noise figure with high IP_3 . Typical applications include narrow and broadband linear amplifiers in industrial and military systems.

The MSA-series is fabricated using Avago's 10 GHz f_T , 25 GHz f_{MAX} silicon bipolar MMIC process which uses nitride self-alignment, ion implantation, and gold metallization to achieve excellent performance, uniformity and reliability. The use of an external bias resistor for temperature and current stability also allows bias flexibility.

Features

- High Dynamic Range Cascadable 50Ω or 75Ω Gain Block
- 3 dB Bandwidth: 50 MHz to 1.6 GHz
- 17.5 dBm Typical $P_{1\text{ dB}}$ at 0.5 GHz
- 12 dB Typical 50 Ω Gain at 0.5 GHz
- 3.5 dB Typical Noise Figure at 0.5 GHz
- Hermetic Gold-ceramic Microstrip Package

100 mil Package

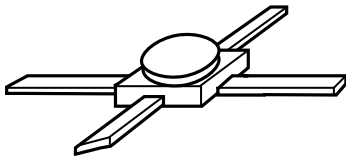

Typical Biasing Configuration

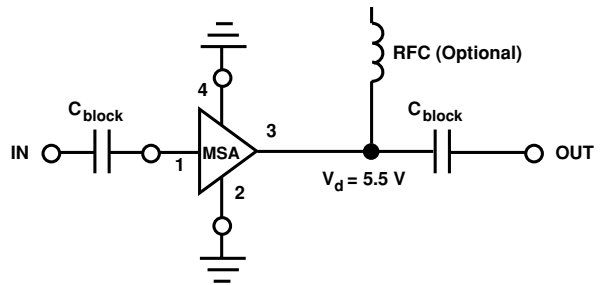

MSA-1110 Absolute Maximum Ratings

Parameter	Absolute Maximum ^[1]
Device Current	90 mA
Power Dissipation ^[2,3]	560 mW
RF Input Power	+13 dBm
Junction Temperature	200°C
Storage Temperature	-65 to 200°C

Thermal Resistance^[2, 4]:

$$\theta_{jc} = 135^{\circ}\text{C/W}$$

Notes:

1. Permanent damage may occur if any of these limits are exceeded.
2. $T_{\text{CASE}} = 25^{\circ}\text{C}$.
3. Derate at $7.4 \text{ mW}/^{\circ}\text{C}$ for $T_{\text{C}} > 124^{\circ}\text{C}$.
4. The small spot size of this technique results in a higher, though more accurate determination of θ_{jc} than do alternate methods.

Electrical Specifications^[1], $T_{\text{A}} = 25^{\circ}\text{C}$

Symbol	Parameters and Test Conditions: $I_{\text{d}} = 60 \text{ mA}$, $Z_0 = 50 \Omega$	Units	Min.	Typ.	Max.
G_{p}	Power Gain ($ S_{21} ^2$) $f = 0.1 \text{ GHz}$	dB	11.5	12.5	13.5
ΔG_{p}	Gain Flatness $f = 0.1 \text{ to } 1.0 \text{ GHz}$	dB		± 0.7	± 1.0
$f_{3 \text{ dB}}$	3 dB Bandwidth ^[2]	GHz		1.6	
VSWR	Input VSWR $f = 0.1 \text{ to } 1.0 \text{ GHz}$			1.7:1	
	Output VSWR $f = 0.1 \text{ to } 1.0 \text{ GHz}$			1.9:1	
NF	50 Ω Noise Figure $f = 0.5 \text{ GHz}$	dB		3.5	4.5
$P_{1 \text{ dB}}$	Output Power at 1 dB Gain Compression $f = 0.5 \text{ GHz}$	dBm	16.0	17.5	
IP_3	Third Order Intercept Point $f = 0.5 \text{ GHz}$	dBm		30.0	
t_{D}	Group Delay $f = 0.5 \text{ GHz}$	psec		160	
V_{d}	Device Voltage	V	4.5	5.5	6.5
dV/dT	Device Voltage Temperature Coefficient	mV/ $^{\circ}\text{C}$		-8.0	

Notes:

1. The recommended operating current range for this device is 40 to 75 mA. Typical performance as a function of current is on the following page.
2. Referenced from 50 MHz gain (GP).

MSA-1110 Typical Scattering Parameters ($Z_0 = 50 \Omega$, $T_A = 25^\circ\text{C}$, $I_d = 60 \text{ mA}$)

Freq. GHz	S_{11}			S_{21}			S_{12}		S_{22}		k
	Mag	Ang	dB	Mag	Ang	dB	Mag	Ang	Mag	Ang	
.0005	.83	-7	19.5	9.44	176	-31.9	.025	39	.84	-7	0.77
.005	.54	-50	16.8	6.92	158	-18.7	.116	34	.55	-50	0.60
.025	.15	-78	13.0	4.47	167	-16.6	.148	9	.15	-79	1.03
.050	.10	-64	12.6	4.26	171	-16.5	.149	5	.10	-67	1.08
.100	.08	-63	12.5	4.23	171	-16.5	.150	4	.08	-66	1.09
.200	.09	-74	12.4	4.17	166	-16.4	.152	4	.09	-78	1.09
.300	.11	-85	12.3	4.10	160	-16.2	.154	5	.12	-89	1.07
.400	.13	-94	12.3	4.10	154	-16.1	.157	6	.15	-98	1.05
.500	.16	-102	12.1	4.04	148	-15.9	.161	7	.18	-106	1.02
.600	.18	-108	12.0	3.98	143	-15.6	.165	8	.20	-113	1.00
.700	.21	-114	11.8	3.89	137	-15.4	.169	8	.23	-120	0.97
.800	.23	-120	11.6	3.80	131	-15.2	.173	8	.25	-126	0.95
.900	.25	-126	11.4	3.71	126	-15.0	.178	8	.28	-132	0.92
1.000	.27	-131	11.1	3.60	120	-14.8	.182	8	.30	-137	0.91
1.500	.36	-153	9.8	3.10	96	-13.8	.203	4	.37	-160	0.83
2.000	.42	-171	8.4	2.64	74	-13.3	.217	1	.40	-178	0.82
2.500	.47	177	7.2	2.29	59	-12.5	.236	-2	.41	172	0.80
3.000	.47	159	5.9	1.97	43	-13.2	.220	-10	.38	157	0.95

Typical Performance, $T_A = 25^\circ\text{C}$, $Z_0 = 50 \Omega$

(unless otherwise noted)

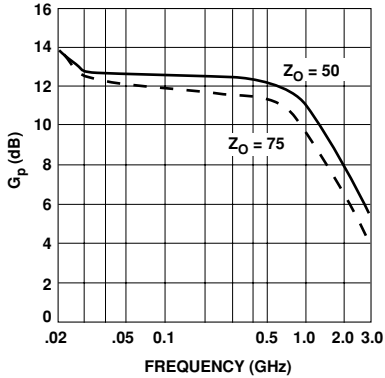

Figure 1. Typical Power Gain vs. Frequency, $I_d = 60 \text{ mA}$.

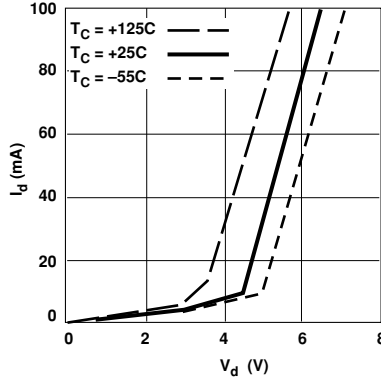

Figure 2. Device Current vs. Voltage.

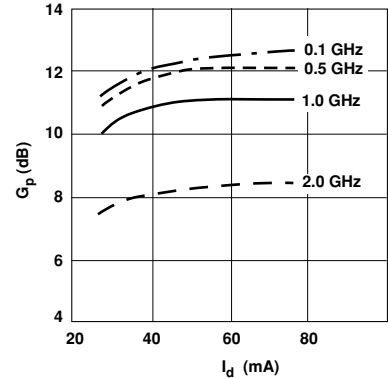

Figure 3. Power Gain vs. Current.

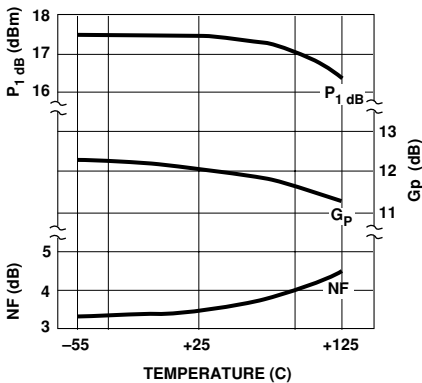

Figure 4. Output Power at 1 dB Gain Compression, Noise Figure and Power Gain vs. Case Temperature, $f = 0.5 \text{ GHz}$, $I_d = 60 \text{ mA}$.

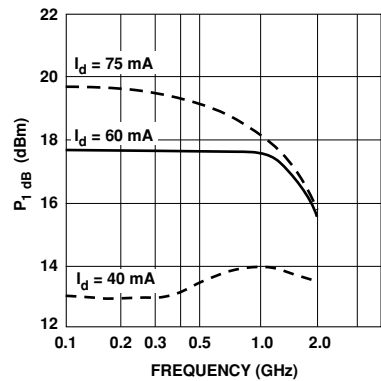

Figure 5. Output Power at 1 dB Gain Compression vs. Frequency.

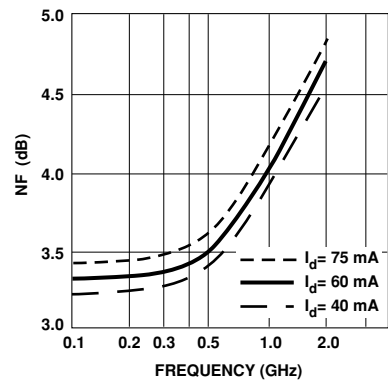
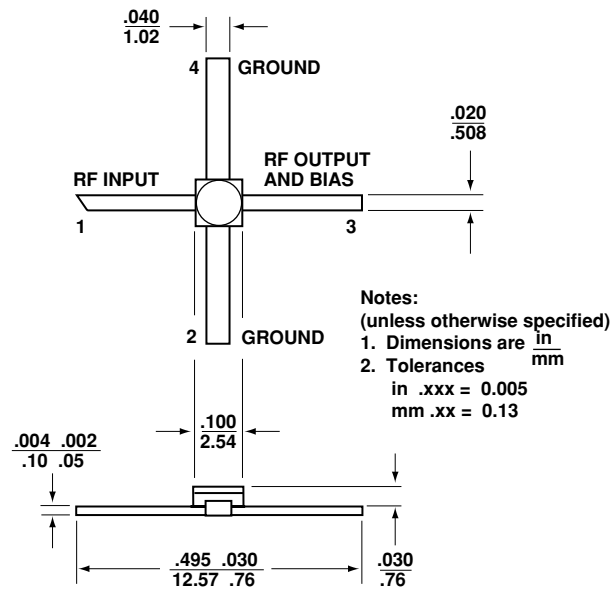

Figure 6. Noise Figure vs. Frequency.

Ordering Information

Part Numbers	No. of Devices	Comments
MSA-1110	100	Bulk

100 mil Package Dimensions



For product information and a complete list of distributors, please go to our web site: www.avagotech.com

Avago, Avago Technologies, and the A logo are trademarks of Avago Technologies, Limited in the United States and other countries. Data subject to change. Copyright © 2008 Avago Technologies, Limited. All rights reserved. Obsoletes 5989-2747EN AV02-1233EN - May 29, 2008

AVAGO
TECHNOLOGIES