



Chipsmall Limited consists of a professional team with an average of over 10 year of expertise in the distribution of electronic components. Based in Hongkong, we have already established firm and mutual-benefit business relationships with customers from,Europe,America and south Asia,supplying obsolete and hard-to-find components to meet their specific needs.

With the principle of “Quality Parts,Customers Priority,Honest Operation,and Considerate Service”,our business mainly focus on the distribution of electronic components. Line cards we deal with include Microchip,ALPS,ROHM,Xilinx,Pulse,ON,Everlight and Freescale. Main products comprise IC,Modules,Potentiometer,IC Socket,Relay,Connector.Our parts cover such applications as commercial,industrial, and automotives areas.

We are looking forward to setting up business relationship with you and hope to provide you with the best service and solution. Let us make a better world for our industry!



## Contact us

Tel: +86-755-8981 8866 Fax: +86-755-8427 6832

Email & Skype: info@chipsmall.com Web: www.chipsmall.com

Address: A1208, Overseas Decoration Building, #122 Zhenhua RD., Futian, Shenzhen, China



*Prime moving products from PANDUIT are part numbers printed in bold typeface. They are stocked items for rapid response and available from our local distributors.*

<b>Table of Contents – SA101N16J-NL</b>	<b>Page</b>
<b>PAN-STEEL™ Stainless Steel Ties – Overview</b> .....	2-3
<b>PAN-STEEL Stainless Steel Ties – MLT Series and WAVE-TY™ Series</b> .....	4
<b>PAN-STEEL Custom Length Banding System – MBS &amp; MBH</b> .....	5
<b>Coated Stainless Steel Ties – MLTC Series and Cushion Sleeving</b> .....	6
<b>Double Wrapped Stainless Steel Ties – MLTDH Series</b> .....	7
<b>Installation Tools for Type MLT, Type MLTC and Type MLTDH Stainless Steel Cable Ties</b> .....	8-9
<b>Stainless Steel, Brass, and Aluminum Marker Plates and Tags</b> .....	11
<b>Custom Marking Capabilities</b> .....	12
<b>Metal Marking Devices</b> .....	13-14
<b>Metal Accessories &amp; Design Kit</b> .....	15
<b>Stainless Steel Mounts</b> .....	16-17
<b>Telcommunications Stackable Cable Spacers</b> .....	18-19
<b>Stainless Steel Tie Technical Data – MLT Series</b> .....	20-21
<b>PAN-STEEL Stainless Steel Strapping System and Custom Length Strapping System</b> .....	22-23
<b>Nylon Coated Stainless Steel Strapping System and Strapping Installation Tool</b> .....	24
<b>PAN-STEEL Applications</b> .....	25-27
<b>Index</b> .....	28

## Stainless Steel Systems And Explanations

### METAL TIES

**PAN-STEEL (MLT Series):** Metal Locking Ties, Ball Lock Version in .18" (4.4mm) and .31" (7.9mm) widths

**CUSTOM LENGTH BANDING SYSTEM:** Ball Lock Version in Reels of 250 ft. (76m) and 1000 ft. (305m); .18" (4.4mm) and .31" (7.9mm) widths

### METAL STRAPS

**STAINLESS STEEL STRAPS (MS Series):** Fold-Over Buckle Design in .375" (9.5mm), .500" (12.7mm) and .625" (15.9mm) widths

**CUSTOM LENGTH STRAPPING SYSTEM:** Fold-Over Buckle Design Provided in Reels of 200 ft. (61m); .375" (9.5mm), .500" (12.7mm) and .625" (15.9mm) widths

**Approvals**

 Military Specification MIL-S-23190E	 ISO 9001 REGISTERED FIRM	 LISTED E56854	 ABS Program s Cert. 99CH18282-X	 United States Coast Guard	
 Bureau Veritas	 Det Norske Veritas	 Lloyd's Register of Shipping	 Germanischer Lloyd	 RINA	

For Technical Assistance, call: 866-405-6659 (outside the U.S., see **page 28** for International Directory)

## PANDUIT PAN-STEEL Stainless Steel Locking Tie

### Design Features (MLT Series)

The **PAN-STEEL** system provides a strong, durable method of bundling, identifying and fastening, which can be used in virtually all indoor, outdoor and underground (including direct burial) applications, including applications where severe environmental conditions exist. The ties are designed for use in critical applications where vibration, radiation, weathering, corrosion and temperature extremes are a factor (refer to [page 21](#) for chemical resistance chart).

#### HIGH STRENGTH

- 100 lb. (445N) and 250 lb. (1112N) minimum loop tensile strengths per Military Standard MIL-S-23190 (refer to [page 20](#) for details); 120 lb. (534N) for the coated cable ties per Military Standard MIL-S-23190 and 600 lb. (2668N) for the double wrapped ties per Military Standard MIL-S-23190

#### SAFE TO HANDLE

- Rounded sides and smooth surfaces—safe to handle (see below)

#### FAST INSTALLATION

- Low profile, self-locking tie is easy to thread for fast installation
- No special tools required for installation

#### MATERIAL

Non-magnetic stainless steel

- 304—most common for typical outdoor applications
- 316—for superior corrosion resistance in salt water and spray applications

#### TEMPERATURE CAPABILITY

Type 304 – -112°F (-80°C) to 1000°F (538°C)

Type 316 – -112°F (-80°C) to 1000°F (538°C)

Type 321 – -112°F (-80°C) to 1700°F (925°C)

(Refer to [page 20](#) for details.)

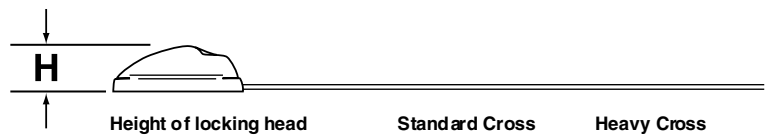

Standard Cross Section Ties H = .16" (4.1mm)	Heavy Cross Section Ties H = .21" (5.3mm)
Heavy Cross Section Coated Ties H = .235" (6.0mm)	Heavy Cross Section Double Wrapped Ties H = .21" (5.7mm)



Contact the factory for registrar and product scope information

### Advantages of the Rounded Sides of PAN-STEEL Stainless Steel Ties



Cross sectional view of other manufacturer's tie body. (Photo micrograph shown is magnified 150X.)



Cross sectional view of **PANDUIT** tie body. (Photo micrograph shown is magnified 150X.)

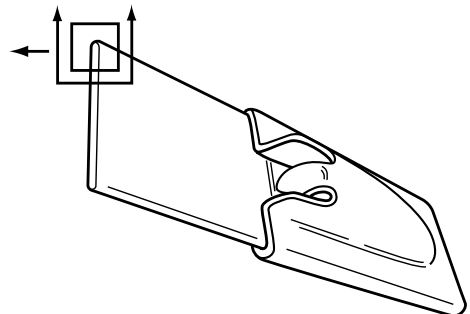

Side view of **PANDUIT** tie.

The **PAN-STEEL** Stainless Steel cable tie is designed for superior comfort and safety when handling due to its fully rounded sides and smooth surfaces. Smooth surfaces and rounded sides assure cable protection and operator safety. **PANDUIT** not only removes the burr, but actually passes the material through a secondary process which removes the top and bottom corners of the material.

**PANDUIT PAN-STEEL Stainless Steel Locking Tie (MLT Series)**



The unique self-locking design simplifies installation and eliminates any protruding ends when used with **PANDUIT** installation tooling (refer to *pages 8, 9 and 10*) on resilient bundles. Other bundles can be made resilient by the use of PCS cushion sleeving (refer to *page 6*). Two widths are available: .18" (4.4mm) and .31" (7.9mm) both .010" (0.254mm) thick and provide 100 lb. (445N) or 250 lb. (1112N) minimum loop tensile strength per MIL-S-23190. Available in stock lengths for outside bundle diameters up to 14" (356mm). Large lengths can be custom made or use the custom length banding system to provide unlimited lengths (see *page 5* for details).

**Exclusive Locking Method**

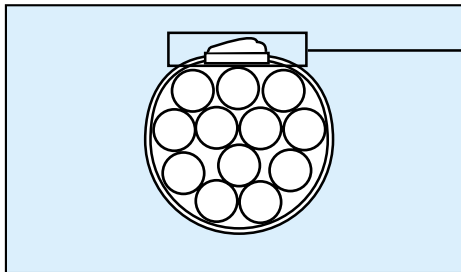

Typical Cable Bundle

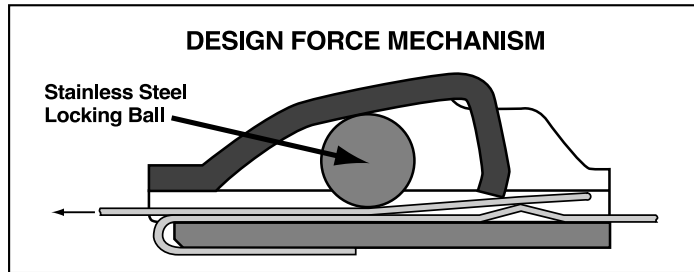

Locking Head Cross Section

Unique stainless steel ball locking design allows smooth entry of the tie body for ease of threading. The ball is permanently entrapped in the head portion of the tie. When the tail of the tie is passed through the locking head, the tail is forced upward by the ramp (see drawing) which creates constant contact between the tie and the locking ball. This contact assures locking in any position (upside down, sideways, etc.). When locked on a bundle, the ball, working in conjunction with the angled ramp of the head, provides a positive mechanical wedge locking action. The forces created by this wedging action are so great that mechanical deformation of the tie body occurs at the point of contact between the ball and tie, locking the tie.

**Self-Locking Head for Fast Installation**



1. Place tie around bundle, put tip through head and pull up tight by hand.

For additional tool information refer to *pages 8, 9 and 10* for details.



2. Use one of the **PANDUIT PAN-STEEL** installation tools to tension and cut off excess tail quickly.

The stainless steel metal locking tie series can be fastened by hand as shown in **Photo 1**. No tools are required. Just place around bundle, pull the tip of the tail through the locking head and pull up tight by hand. The self-locking head secures the tie in place. **Photo 2** shows the metal locking tie series being installed with the **PANDUITGS4MT** tool which automatically tensions and cuts off excess tie. The system provides adjustable tension control and automatic cut-off for quick, consistent and secure installation with the lowest installed cost.

**Part Number System Example – MLT Series**

(Stock Size Tie)

MLT	6	S	—	CP	Material
Part Description	Bundle Diameter Reference	Cross-Section		Package Qty.	(blank) = 304
Metal Locking Tie	(inches)	S = Standard H = Heavy		Q = 25 L* = 50 LP** = 50 CP = 100	316 = 316
				*Standard Cross-Section **Heavy Cross-Section	

## PAN-STEEL Stainless Steel Ties



MLT-S Standard Cross-Section:



MLT-H Heavy Cross-Section:

The **PAN-STEEL** system provides a strong durable method of bundling, identifying and fastening. Can be used in virtually all indoor, outdoor and underground (including direct burial) applications, especially where severe environmental conditions exist.

Three types of materials available: AISI 304 non-magnetic stainless steel—for most applications; AISI 316 non-magnetic stainless steel—for applications requiring superior corrosion resistance. AISI 321 non-magnetic stainless steel material for high temperature applications. Contact factory for details.

Part Number	Material & Cross Section	Min. Loop Tensile Strength Lbs. (N*)	Max. Bundle Dia. in. (mm)	Length ** in. (mm)	Thickness & Width in. (mm)	Recommended PANDUIT Installation Tool *** Part Number	Pkg. Qty.	Ctn. Qty.				
<b>Type AISI 304</b>												
<b>MLT1 S-CP</b>	304 Std.	100 (445)	1.00(25)	5.0(127)	.010(0.25) X .18(4.4)	PPTMT GS4MT ST2MT or HTMT	100	500				
<b>MLT2S-CP</b>			2.00(50)	7.9(201)			100	500				
MLT2S-L			2.00(50)	7.9(201)			50	500				
<b>MLT2.7S-CP</b>			2.70(69)	10.2(259)			100	500				
<b>MLT4S-CP</b>			4.00(102)	14.3(362)			100	500				
MLT4S-L			4.00(102)	14.3(362)			50	500				
<b>MLT6S-CP</b>			6.00(152)	20.5(521)			100	500				
<b>MLT8S-CP</b>			8.00(203)	26.8(679)			100	500				
MLT10S-CP			10.00(254)	33.0(838)			100	500				
MLT12S-Q			12.00(305)	42.0(1067)			25	125				
MLT14S-Q			14.00(356)	47.0(1194)			25	125				
MLT15S-Q			15.00(380)	49.2(1250)			25	125				
<b>Type AISI 316</b>												
<b>MLT1 S-CP316</b>			316 Std.	100 (445)			1.00(25)	5.0(127)	.010(0.25) X .18(4.4)	PPTMT GS4MT ST2MT or HTMT	100	500
<b>MLT2S-CP316</b>							2.00(50)	7.9(201)			100	500
<b>MLT4S-CP316</b>	4.00(102)	14.3(362)			100	500						
MLT6S-CP316	6.00(152)	20.5(521)			100	500						
MLT8S-CP316	8.00(203)	26.8(679)			100	500						
MLT10S-CP316	10.00(254)	33.0(838)			100	500						
<b>MLT2H-LP316</b>	316 Hvy.	250 (1112)	2.00(50)	7.9(201)	.010(0.25) X .31(7.9)	PPTMT GS4MT ST2MT or HTMT	50	250				
MLT2.7H-LP			2.70(69)	10.2(259)			50	250				
<b>MLT4H-LP</b>			4.00(102)	14.3(362)			50	250				
<b>MLT6H-LP</b>			6.00(152)	20.5(521)			50	250				
<b>MLT8H-LP</b>			8.00(203)	26.8(679)			50	250				
<b>MLT10H-LP316</b>			10.00(254)	33.0(838)			50	250				

### Type AISI 316

<b>MLT1 S-CP316</b>	316 Std.	100 (445)	1.00(25)	5.0(127)	.010(0.25) X .18(4.4)	PPTMT GS4MT ST2MT or HTMT	100	500
<b>MLT2S-CP316</b>			2.00(50)	7.9(201)			100	500
<b>MLT4S-CP316</b>			4.00(102)	14.3(362)			100	500
MLT6S-CP316			6.00(152)	20.5(521)			100	500
MLT8S-CP316			8.00(203)	26.8(679)			100	500
MLT10S-CP316			10.00(254)	33.0(838)			100	500
<b>MLT2H-LP316</b>	316 Hvy.	250 (1112)	2.00(50)	7.9(201)	.010(0.25) X .31(7.9)	PPTMT GS4MT ST2MT or HTMT	50	250
<b>MLT4H-LP316</b>			4.00(102)	14.3(362)			50	250
<b>MLT6H-LP316</b>			6.00(152)	20.5(521)			50	250
<b>MLT8H-LP316</b>			8.00(203)	26.8(679)			50	250
<b>MLT10H-LP316</b>			10.00(254)	33.0(838)			50	250

\*Per Military Specification MIL-S-23190. For additional details, see [page 20](#).

\*\*Other lengths available, contact factory.

\*\*\*Refer to [pages 8, 9](#) and [10](#) for information on installation tools.

Order number of ties required in multiples of Pkg. Qty.



## Superior Grip Stainless Steel Ties



Part Number	Material & Cross Section	Min. Loop Tensile Strength Lbs. (N*)	Max. Bundle Dia. in. (mm)	Length in. (mm)	Thickness & Width in. (mm)	Recommended PANDUIT Installation Tool *** Part Number	Pkg. Qty.	Ctn. Qty.
<b>WAVE-TY SERIES</b>								
<b>MLT2.7WH-LP</b>	304 Hvy.	200 (890)	2.70(70)	10.2(259)	.010(0.25) X .31(7.9)	PPTMT GS4MT ST2MT or HTMT	50	250
<b>MLT4WH-LP</b>			4.00(102)	14.2(361)			50	250
<b>MLT6WH-LP</b>			6.00(152)	20.5(521)			50	250
<b>MLT8WH-LP</b>			8.00(203)	26.8(631)			50	250
<b>MLT10WH-LP</b>			10.00(254)	33.0(838)			50	250

\*Per Military Specification MIL-S-23190. For additional details, see [page 20](#).

\*\*\*Refer to [pages 8, 9](#) and [10](#) for information on installation tools.

Order number of ties required in multiples of Pkg. Qty.

### The Patented WAVE FORM Spring in the WAVE-TY

- Tightly clamps on applications where other stainless steel ties will not function
- Retains tension on a solid bundle with minimal applied force
- Tension may be created with a manual tool or **PANDUIT** installation tooling
- Available in Type 304 and 316 stainless steel

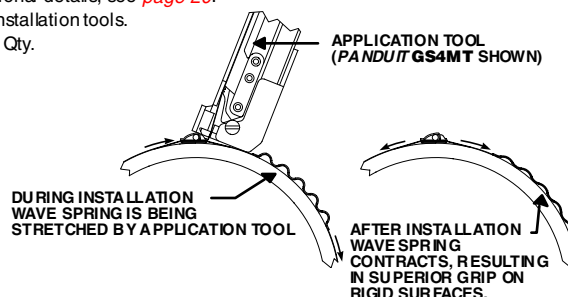

## Custom Length Banding System MBS and MBH Banding



- For applications that require bundling various bundle diameters
- Supplied in reels of 250 ft. (76m) or 1000 ft. (305m)
- Lets you bundle any size bundle diameter
- To use, pull out as much banding as needed, cut off with **PANDUIT** GS4MT with CAMT accessory (refer to [page 9](#)) or with shears and install with MTHS or MTHH banding heads (shown below)

Part Number	Cross Section	Min. Loop Tensile Strength Lbs. (N *)	Max. Bundle Dia. in. (mm)	Length ft. (m)	Thickness & Width in. (mm)	Recom-mended Tool**	Recom-mended Banding Head	Pkg. Qty.
<b>Type AISI 304</b>								
<b>MBS-TLR</b>	Std.	100 (445)	Any	250 (76)	.010 (0.25) X .18 (4.4)	PPTMT GS4MT ST2MT or HTMT	MTHS-C	1
MBS-MR	Std.	100 (445)	Any	1000 (305)			MTHS-C	1
<b>MBH-TLR</b>	Hvy.	250 (1112)	Any	250 (76)	.010 (0.25) X .31 (7.9)		MTHH-C	1
<b>MBH-MR</b>	Hvy.	250 (1112)	Any	1000 (305)			MTHH-C	1

### Type AISI 316

MBS-TLR316	Std.	100 (445)	Any	250 (76)	.010 (0.25) X .18 (4.4)	PPTMT GS4MT ST2MT or HTMT	MTHS-C316	1
MBS-MR316	Std.	100 (445)	Any	1000 (305)			MTHS-C316	1
MBH-TLR316	Hvy.	250 (1112)	Any	250 (76)	.010 (0.25) X .31 (7.9)		MTHH-C316	1
MBH-MR316	Hvy.	250 (1112)	Any	1000 (305)			MTHH-C316	1

\*Per Military Specification ML-S-23190. For additional details, see [page 20](#).

\*\*The GS4MT with CAMT accessory is recommended for cutting the banding. This system provides a straight cut-off which assists in head assembly and eliminates the need for shears. Refer to [pages 8, 9](#) and [10](#) for information on installation tools.

Pkg. -MR = 1000 ft. (305m) reel and -TLR = 250 ft. (76m) reel.

Order number of reels required.

**To determine the proper amount of banding required, use the following formula.**

### To Determine Length of Banding Needed

Calculate	Example: 10 in. (250 mm) Diameter Bundle.
Diameter inches (mm) X 3.14 + 3 inches (76 mm)	10 in. (250 mm) X 3.14 = 31.40 + 3 in. (76 mm + 76 mm) = 34.40 in. or 35 in. of banding (861 mm of banding) required.

## MTHS and MTHH Banding Heads



To use, take one end of the cut banding and bend back ½" (13mm). Take a self-locking head and slide it the entire length of the band until it reaches the bend. Bend tail flat against bottom of banding head to complete assembly.

Part Number	Description	Pkg. Qty.	Ctn. Qty.
<b>MTHS-C</b>	Loose piece banding head for standard cross section banding, 304 stainless steel.	100	1000
MTHS-C316	Loose piece banding head for standard cross section banding, 316 stainless steel.	100	1000
<b>MTHH-C</b>	Loose piece banding head for heavy cross section banding, 304 stainless steel.	100	1000
MTHH-C316	Loose piece banding head for heavy cross section banding, 316 stainless steel.	100	1000

Refer to [pages 8, 9](#) and [10](#) for information on installation tools.

Order number of banding heads required in multiples of Pkg. Qty.

## Selectively Coated Stainless Steel Cable Ties — MLTC Series



Part Number	Material & Cross Section	Min. Loop Tensile Strength Lbs. (N*)	Max. Bundle Dia. in. (mm)	Length in. (mm)	Thickness & Width** in. (mm)	Recommended PANDUIT Installation Tool*** Part No.	Pkg. Qty.	Ctn. Qty.
<b>MLTC2H-LP316</b>	316 Hvy.	120 (534)	2.00 (50)	7.9 (201)	.010 (0.25)	PPTMT	50	250
<b>MLTC4H-LP316</b>			4.00 (102)	14.3 (362)		GS4MT	50	250
<b>MLTC6H-LP316</b>			6.00 (152)	20.5 (521)	X	50	250	
MLTC8H-LP316			8.00 (203)	26.8 (679)	.31 (7.9)	or	50	250
MLTC10H-LP316			10.00 (254)	33.0 (838)		HTMT	50	250

\*Per Military Specification MIL-S-23190.

\*\*Base material less coating

\*\*\*Refer to [pages 8, 9 and 10](#) for information on installation tools.

Order number of ties required in multiples of Pkg. Qty.

These patented ties are designed with a protective coating, smooth surfaces and rounded sides assure cable protection and operator safety. They combine the superior strength and corrosion resistance necessary to withstand even the harshest conditions, such as severe weathering and prolonged exposure to salt spray.

### Features and Benefits:

- For communication and electrical cables
- The strength of steel, the protection of nylon; the nylon coating provides protection for the cable
- Available in a loop tensile strength of 120 lbs.
- Base metal is 316 grade stainless steel for excellent resistance to temperature extremes, corrosion, weather, chemicals, salt sprays and UV radiation



### Nylon 11 Coating:

- Excellent resistance to chemicals and salt sprays
- Halogen-free with good self-extinguishing properties
- Good in applications at temperatures down to  $-40^{\circ}\text{F}$  ( $-40^{\circ}\text{C}$ )
- Upper temperature limit  $285^{\circ}\text{F}$  ( $140^{\circ}\text{C}$ )
- Coating thickness .002 in. (.050mm) / .006 in. (0.152mm) per side



## PCS Cushion Sleeve



Black vinyl sleeving slips on **PAN-STEEL™** steel ties and custom length banding and is used on applications requiring improved gripping on non-resilient objects, separation between dissimilar metals, and added bundle protection. Can be used indoors or outdoors (excellent ultraviolet resistance, good resistance to petroleum and many chemicals).

Provides full separation between the ties and the material to which you are fastening. Instructions are included with the package or available upon request.



Part Number	Width in. (mm)	Length Ft. (m)	Pkg. Qty.	Ctn. Qty.
<b>PCSS-CR</b> Used with standard cross section ties or custom length banding system	0.31 (.87)	100 (30.5)	1	—
<b>PCSH-CR</b> Used with heavy cross section ties or custom length banding system	.47 (1.94)	100 (30.5)	1	—

Bulk Pkg. -CR = 100 ft. (30.5m) reel.

Order number of reels required.

**Operating Temperature Range =**  
 $41^{\circ}\text{F} - 167^{\circ}\text{F}$   
 $(5^{\circ}\text{C} \text{ to } 75^{\circ}\text{C})$

**Double Wrapped Stainless Steel Cable Ties  
— MLTDH Series**

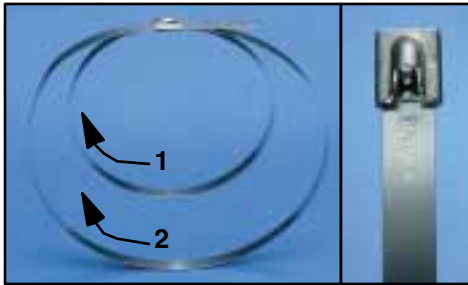

Part Number	Material & Cross Section	Min. Loop Tensile Strength Lbs. (N*)	Max. Bundle Dia. in. (mm)	Length in. (mm)	Thickness & Width in. (mm)	Recommended PANDUIT Installation Tool** Part No.	Pkg. Qty.	Ctn. Qty.
MLT2DH-L	304 Hvy.	600 (2669)	2.00 (50)	18.5 (470)	.010 (.254)	PPTMT GS4MT ST2MT or HTMT	50	500
MLT4DH-L			4.00 (102)	28.0 (711)	X			
MLT5DH-L			5.00 (125)	34.0 (863)	.31 (7.9)			

\*Per Military Specification MIL-S-23190.

\*\*Refer to [pages 8, 9](#) and [10](#) for information on installation tools.

Order number of ties required in multiples of Pkg. Qty.

Cable tie body wraps around two times entering the locking head twice.

**Double Wrapped  
Stainless Steel Cable Ties**

- Double wrapped stainless steel cable ties in 304 material for extra high strength in critical applications
- Double wrapped stainless steel ties allow for tighter tensioning on non-resilient bundles
- Available in .31 in. (7.9 mm) width for bundle diameters ranging from 1 in. (25 mm) – 5 in. (125 mm)
- Loop tensile strength of 600 lbs. (2669 N)
- Self-locking ties—no tools required
- Optional tooling is available to speed installation and lower installed costs (see [pages 8, 9](#) and [10](#))



Double wrapped stainless steel cable ties allow the cable tie body to pass through the locking head two times which provides extra high strength, tighter tension on non-resilient bundles (see photo 1) and a more secure seal on rubberboots (see photo 2).



## Installation Tools for All Stainless Steel Cable Ties and Custom Length Banding System

A large selection of state-of-the-art installation tooling allows you to choose the proper tool to meet all your requirements—no matter what your application. These tools are lightweight and easy to operate. Because they are fast and efficient, they speed cable tie installation and lower your total installed cost. The **PANDUIT** PPTMT and GS4MT tools automatically cut off excess tie when the pre-set tension level is reached.



### PPTMT (Pneumatic)



Part Number	Description	Pkg. Qty.
<b>PPTMT</b>	Used with all <b>PAN-STEEL™</b> Type MLT ties, Type MLTC Coated ties, Type MLTDH Double Wrapped ties and <b>WAVE-TY™</b> Superior Grip ties. <ul style="list-style-type: none"> <li>• Automatically tensions and cuts off tie flush* when predetermined tension is reached, providing more reliable and consistent installations.</li> <li>• Ideal for high production applications</li> <li>• Installs both standard .18 in. (4.4 mm) and heavy .31 in. (7.9 mm) cross section ties with the flip of the knob. (See below.)</li> </ul>	1
PPH10	10 ft. (3 m) hose assembly; 1/8 in. (3.175 mm) NPT male connector	1
PL289N1	Filter regulator	1
KPPTMTG	Replacement gripper kit for PPTMT	1
KPPTMTB	Replacement blade kit for PPTMT	1

\*When installing over resilient objects (or made resilient by using PCS cushion sleeve). Order number of pieces required.

Power assisted (pneumatic tool) will automatically tension and cut off excess tie when predetermined tension is reached with the squeeze of a trigger.

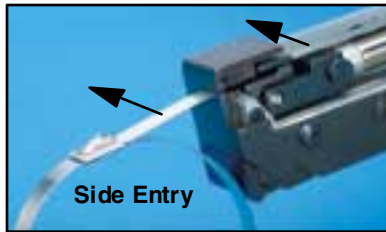

#### Features and Benefits:

- Power assisted tool for fast and effortless installation
- Cable tie side entry for immediate positioning of tie and tool (see photo)
- Controlled tension, fully adjustable
- Automatic cut-off
- One hand operation - lightweight
- Easy removal of excess tie
- Operates on 75 – 85 PSI (517-586 KPA Bar) non-lubricated air and requires no special maintenance

## Adjustment Features for PPTMT and GS4MT \* Tools

#### Fast and Easy Selection



The cross-section of the cable tie being installed is clearly indicated on

the knob. To change, simply flip knob to proper cross-section indicator.

#### Tension Indicator



Each cross-section of cable ties can be installed with a variety of tensions to meet the application.

The proper tensions (listed on **PANDUIT** cable tie packages) are clearly marked with this indicator.

#### To Change the Tension:



Turn clockwise to increase.



Turn counter-clockwise to decrease.

\* See [page 9](#) for information on GS4MT installation tool.

## Installation Tools for All Stainless Steel Cable Ties and Custom Length Banding System (cont.)

### GS4MT



Hand Operated Tool: tool-controlled tension and cut-off. This tool will automatically tension and cut excess tie when predetermined tension is reached with the squeeze of a handle.

#### Features and Benefits:

- Single handle operation for fast installation
- Cable tie side entry for immediate positioning of tie and tool (See photo)
- Controlled tension, fully adjustable
- Automatic cut-off
- One hand operation - lightweight
- Easy removal of excess tie
- Qualified product listed per Military Standard MS90387-3 and Military Specification MIL-T-81306A

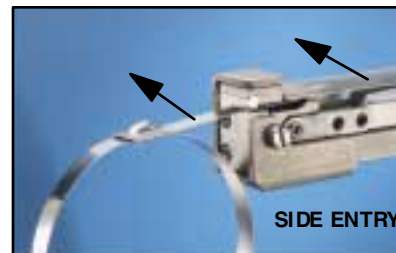

Part Number	Description	Pkg. Qty.
<b>GS4MT</b>	Used with all <b>PAN-STEEL™</b> Type MLT ties, Type MLTC Coated ties, Type MLTDH Double Wrapped ties and <b>WAVE-TY™</b> Superior Grip ties. <ul style="list-style-type: none"> <li>• Automatically tensions and cuts off tie flush* when predetermined tension is reached, providing more reliable and consistent installations.</li> <li>• Installs both standard .18 in. (4.4mm) and heavy .31 in. (7.9mm) cross section ties with the flip off of the knob (see <a href="#">page 8</a>).</li> </ul>	1
K4M-BLD	Replacement cutter blade for GS4MT	1
K4MTG	Replacement tension gripper for GS4MT	1
CAMT	Cut-off accessory. Use this accessory with GS4MT tool to cut MBH or MBS continuous banding. Accessory drops in place for use.	1

\*When installing over resilient objects (or made resilient by using PCS cushion sleeve). Order number of pieces required.

### Accessories

#### Tool Tension Lock Kit

Certain applications require a locking device on either the selector knob (one cross-section size and tension only) or tension level adjustment (but allowing cross-section size changes). This kit is available for that purpose.

Part Number	Description	Pkg. Qty.
TTLK3-X	<b>Tool Tension Lock Kit</b> Each kit contains (1) #4-40 selection locking screw (with head), (1) selection locking clip, and (1) #4-40 tension locking screw (headless).	10



To lock selector knob and tension level



To lock fine adjustment

Order number of kits required in multiples of Pkg. Qty.

### GHH Holster



Part Number	Description	Pkg. Qty.
GHH	Designed to hold <b>PANDUIT</b> GS4MT and ST2MT tools. Can also be used with GS2B, GS4H (series), PPTS, PPTEH, and ST2EH nylon cable tie installation tools. All leather and rivet construction for durability. Extra tie-down strap holds tool in place, easily fits on belt. Used wherever the hand tools are used – construction sites to assembly line for a convenient and handy place for the tool.	1

Order number of holsters required.

## Installation Tools for All Stainless Steel Cable Ties and Custom Length Banding System (cont.)

### ST2MT



Hand Operated Tool.  
Installer controlled tension and cut-off.

Part Number	Description	Pkg. Qty.
<b>ST2MT</b>	<ul style="list-style-type: none"> <li>Tool tension is controlled by installer. Flush* cut-off is made by twisting the tool.</li> <li>Rugged, lightweight, easy-to-operate pliers-type tool provides mechanical advantage.</li> <li>Used with all <b>PAN-STEEL™</b> type MLT ties, type MLTC coated ties, type MLTDH double wrapped ties and <b>WAVE-TY™</b> superior grip ties.</li> </ul>	1
KT2MG	<b>KT2MG Replacement Gripper Kit</b> <ul style="list-style-type: none"> <li>Replaces tension gripper on ST2MT tool.</li> <li>Can be part of a maintenance program.</li> <li>Extends life of tool.</li> </ul>	1

\*When installing over resilient objects (or made resilient by using PCS cushion sleeve).  
Order number of pieces required.

#### Features and Benefits:

- Single handle trigger for fast installation
- Cable tie side entry for immediate positioning of tie and tool (see photo)
- One hand operation - lightweight
- Installer controlled tension
- Cut-off capability with the twist of the wrist
- Easy removal of excess tie

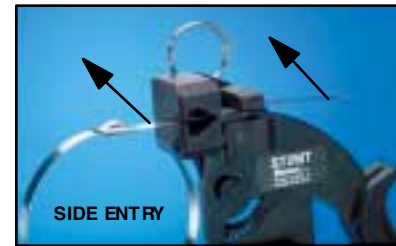

### HTMT



Installer controlled tension.

Part Number	Description	Pkg. Qty.
<b>HTMT</b>	<ul style="list-style-type: none"> <li>Specially adapted screwdriver type tool is used to tension standard and heavy cross-section ties—safely.</li> <li>Economical</li> <li>The coiled tie end remaining after tensional assures a safe end.</li> <li>Manual tension, no cut-off.</li> <li>Used with all <b>PAN-STEEL</b> type MLT ties, type MLTC coated ties, type MLTDH double wrapped ties and <b>WAVE-TY</b> superior grip ties.</li> <li>Installs ties parallel to the bundle.</li> </ul>	1

Order number of tools required.

### SBT



SBT Bit only – electric screwdriver not included.

Part Number	Description	Pkg. Qty.
SBT	<ul style="list-style-type: none"> <li>Tool can be used in any electric screwdriver or nutdriver that accepts 1/4 in. hex bits</li> <li>Used with all <b>PAN-STEEL</b> type MLT ties, type MLTC coated ties, type MLTDH double wrapped ties and <b>WAVE-TY</b> superior grip ties.</li> <li>No cut-off – coiled tie end remaining after tensioning.</li> <li>Installs ties parallel to the bundle.</li> </ul>	1

Order number of tools required.

## Stainless Steel, Brass and Aluminum Marker Plates and Tags



- Identify pipes, conduit, valves, cables and equipment in petrochemical plants, pulp and paper mills, refineries, offshore oil rigs and in many other harsh environments.
- All marker plates/tags can be custom marked by **PANDUIT** with one of two computer controlled systems (laser or embosser) to provide permanent identification to resist corrosion, abrasion and radiation (see [page 13](#) for details).
- Use with **PANDUIT PAN-STEEL™** cable ties (refer to [page 4](#) and [5](#)), or with “S” hooks, and beaded chains (refer to [page 15](#)) for fast installation at lowest installed cost.

Most tags are provided with one 1/4 in. (6.35 mm) hole.

Styles	Marker Plate and Tag Part Numbers	Used with PAN-STEEL Ties	Plate/Tag Size inches W X L (mm)	Material	Approx. Thickness in. (mm)	Pkg. Qty.	Ctn. Qty.
MMP350-C  MMP350H-C	<b>MMP350-C</b> <b>MMP350-C316</b> MMP 350H-C MMP 350H-C316 <b>MMP350W38-C</b> MMP 350W38-C316 MMP 172-C MMP 172-C316 MMP 172W38-C MMP 172W38-C316	MLT-S MLT-S MLT-S/H MLT-S/H MLT-S MLT-S MLT-S MLT-S MLT-S MLT-S MLT-S MLT-S	.75 X 3.50 (19 X 89) .75 X 3.50 (19 X 89) .75 X 3.50 (19 X 89) .75 X 3.50 (19 X 89) .38 X 3.50 (9.6 X 89) .38 X 3.50 (9.6 X 89) .75 X 1.72 (19 X 44) .75 X 1.72 (19 X 44) .38 X 1.72 (9.6 X 44) .38 X 1.72 (9.6 X 44)	304 Stainless 316 Stainless 304 Stainless 316 Stainless 304 Stainless 316 Stainless 304 Stainless 316 Stainless 304 Stainless 316 Stainless	.010 (0.25)	100 100 100 100 100 100 100 100 100 100	1000 1000 1000 1000 1000 1000 1000 1000 1000 1000
MT172W38-C	MT350-C MT350-C316 MT350W38-C MT350W38-C316 MT172-C MT172-C316 MT172W38-C MT172W38-C316	MLT-S* MLT-S* MLT-S* MLT-S* MLT-S* MLT-S* MLT-S* MLT-S*	.75 X 3.50 (19 X 89) .75 X 3.50 (19 X 89) .38 X 3.50 (9.6 X 89) .38 X 3.50 (9.6 X 89) .75 X 1.72 (19 X 44) .75 X 1.72 (19 X 44) .38 X 1.72 (9.6 X 44) .38 X 1.72 (9.6 X 44)	304 Stainless 316 Stainless 304 Stainless 316 Stainless 304 Stainless 316 Stainless 304 Stainless 316 Stainless	.010 (0.25)	100 100 100 100 100 100 100 100	1000 1000 1000 1000 1000 1000 1000 1000
MT350W17-Q	MT338W21-Q MTB338W21-Q MT350W17-Q MTB350W17-Q	MLT-S* MLT-S* MLT-S* MLT-S*	2.13 X 3.38 (54 X 86) 2.13 X 3.38 (54 X 86) 1.73 X 3.50 (44 X 89) 1.73 X 3.50 (44 X 89)	304 Stainless Brass 304 Stainless Brass	.015 (0.38)	25 25 25 25	250 250 250 250
MMP338W21-Q	MMP338W21-Q MMP B338W21-Q MMP 350W17-Q MMP B350W17-Q	MLT-S* MLT-S* MLT-S* MLT-S*	2.13 X 3.38 (54 X 86) 2.13 X 3.38 (54 X 86) 1.73 X 3.50 (44 X 89) 1.73 X 3.50 (44 X 89)	304 Stainless Brass 304 Stainless Brass	.015 (0.38)	25 25 25 25	250 250 250 250
MT1D-Q	MT1D-Q MTB1D-Q MT150D-Q MTB150D-Q MT213D-Q MTB213D-Q	MLT-S* MLT-S* MLT-S* MLT-S* MLT-S* MLT-S*	1.00 CIRCULAR (25) 1.00 CIRCULAR (25) 1.50 CIRCULAR (38) 1.50 CIRCULAR (38) 2.13 CIRCULAR (54) 2.13 CIRCULAR (54)	304 Stainless Brass 304 Stainless Brass 304 Stainless Brass	.035 (0.89) .040 (1.02) .035 (0.89) .040 (1.02) .015 (0.38) .015 (0.38)	25 25 25 25 25 25	250 250 250 250 250 250
AP350HW86-C	AP350HW86-C	MLT-S/H	.86 X 3.50 (22 X 89)	Aluminum	.015 (0.38)	100	1000

\*Also used with “S” Hooks or Beaded Chains (refer to [page 15](#) for details).

Galvanic reaction may occur between stainless steel ties and aluminum marker plates in certain environments causing the aluminum to corrode.

Order number of marker plates/tags required in multiples of Pkg. Qty.

## Custom Marking Capabilities on *PANDUIT PAN-STEEL™* Stainless Steel Cable Ties, Strapping, Metal Marker Plates/Tags and Anodized Aluminum Locks\*



*PANDUIT* stainless steel cable ties, strapping, stainless steel, brass and aluminum marker plates/tags and anodized aluminum locks can be custom marked for identification of equipment, cables, hoses, pipes, conduit, etc. in petrochemical plants, power plants, pulp and paper mills, breweries, and many other applications. *PANDUIT's* in-house computer controlled custom marking systems provide sharp, crisp, high quality legends. Sequential numbering for serialization is available.

\* Anodized aluminum locks can only be marked by the laser system.



### LASER MARKING SYSTEM

- Used on all stainless steel cable ties, strapping, metal marker plates/tags and anodized aluminum locks
- Graphics capability and **BOLD** block letters
- Upper and lower case character capability
- Alphanumeric and sequential numbering ability

Character Sizes \*\* Available:

1/8 in. (3.18 mm)    1/4 in. (6.35 mm)  
3/16 in. (4.77 mm)    5/16 in. (7.94 mm)  
1/2 in. (12.7 mm)

\*\*Other character sizes available. Contact Factory.

### EMBOSSING SYSTEM

- Used on metal marker plates and tags which are a maximum of .020 in. (0.5 mm) thick
- Excellent for applications that are exposed to occasional painting and excessive dirt
- Upper case "raised" character capability only
- Alphanumeric and sequential numbering ability

Character Sizes\*\* Available:

1/8 in. (3.18 mm)    3/16 in. (4.77 mm)

For complete product and specification information visit our website at: [www.panduit.com](http://www.panduit.com)  
or call: **866-405-6659**

Sold exclusively through authorized *PANDUIT* distributors.

## Marking Devices Metal Embossing Tape System



System includes hand operated embossing tool and roll of 304 grade stainless steel and aluminum tape.

- Provides job-site versatility
- Can be used with **PAN-STEEL™** ties as a marker plate or a flag marker
- Excellent for on-site applications requiring quick, easy and permanent identification



Part Number	Description	Pkg. Qty.	Ctn. Qty.																																				
<b>MEHT</b>	<b>Tool Kit</b> Kit: including tool, carrying case (1) roll each META (aluminum) and METS4 (stainless) tape  <b>Characters include:</b> <table border="1" style="display: inline-table; vertical-align: middle;"> <tr> <td>A</td><td>B</td><td>C</td><td>D</td><td>E</td><td>F</td><td>G</td><td>H</td><td>I</td><td>J</td><td>K</td><td>L</td><td>M</td><td>N</td><td>O</td><td>P</td><td>Q</td><td>R</td> </tr> <tr> <td>S</td><td>T</td><td>U</td><td>V</td><td>W</td><td>X</td><td>Y</td><td>Z</td><td>2</td><td>3</td><td>4</td><td>5</td><td>6</td><td>7</td><td>8</td><td>9</td><td>.</td><td>/</td> </tr> </table> 3/16 in. (4.76 mm)  Height (approx. 6 characters per inch (2.54 cm).	A	B	C	D	E	F	G	H	I	J	K	L	M	N	O	P	Q	R	S	T	U	V	W	X	Y	Z	2	3	4	5	6	7	8	9	.	/	1 kit	—
A	B	C	D	E	F	G	H	I	J	K	L	M	N	O	P	Q	R																						
S	T	U	V	W	X	Y	Z	2	3	4	5	6	7	8	9	.	/																						
<b>META-X</b>	<b>Tape</b> 1/2 in. X 16 feet (12.7 mm X 4.88 m) aluminum tape	10 rolls	50 rolls																																				
<b>METS4-X</b>	1/2 in. X 21 feet (12.7 mm X 6.4 m) 304 grade stainless steel tape	10 rolls	50 rolls																																				
<b>METS3-X</b>	1/2 in. X 21 feet (12.7 mm X 6.4 m) 316 grade stainless steel tape  Used with <b>PAN-STEEL</b> Ties and accessories*  Tool punches a single 3/16 in. (4.76 mm) diameter hole for standard cross section size metal locking ties or two holes in succession for heavy cross section metal locking ties.	10 rolls	50 rolls																																				

Galvanic reaction may occur between stainless steel ties and aluminum tape in certain environments causing the aluminum to corrode.

\*"S"-hooks and beaded chain can be used with the tape system. (Refer to [page 15](#) for information.)  
Order number of kits or rolls required in multiples of Pkg. Qty.

## Electric Engraving Pencil



- For engraving of **PAN-STEEL** stainless steel cable ties, straps, marker plates/tags, and brass and aluminum marker plates/tags
- Provides fast, easy permanent identification.

Part Number	Description	Pkg. Qty.
MET	115 volt unit with carbide point	1
MET-DT	Diamond tip accessory for MET engraving tool	1

Order number of pieces required.

## Marking Devices (Cont.)

PANDUIT **PAN-STEEL**™ stainless steel ties, strapping, marking plates/tags can be permanently marked with additional marking devices.

### Indenter Press



- For identification in various environments
- Provides quick, easy, and permanent identification of **PANDUIT PAN-STEEL** stainless steel cable ties, straps, marker plates and tags
- Interchangeable wheels
- Press includes fixtures to hold MMP350 series marker plates, MLT series cable ties, and MS strapping in place to provide high quality marking
- Tool is designed for long life and durability

Part Number	Description	Pkg. Qty.
	<b>Press</b> including (1) wheel  Easy-to-operate manual Indenter Press available with interchangeable Indenter wheels in three character sizes. With the interchangeable feature, one press and three wheel sizes can add versatility to your marking requirements.	
IMP094	Press with 3/32 in. (2.38 mm) character wheel	1
IMP125	Press with 1/8 in. (3.18 mm) character wheel	1
IMP187	Press with 3/16 in. (4.76 mm) character wheel	1
	<b>Interchangeable Wheel Kits</b>	
MWK094	3/32 in. (2.38 mm) character wheel kit (wheel and indexing gear)	1
MWK125	1/8 in. (3.18 mm) character wheel kit (wheel and indexing gear)	1
MWK187	3/16 in. (4.76 mm) character wheel kit (wheel and indexing gear)	1
IMP-FIX	Interchangeable fixture for MMP172, MMP338 and MT Series and the aluminum marker plates.	1

Order number of pieces required.

#### Features:

- Automatic table indexing
- Depth adjustment screw
- Cable tie and marker plate/tag clamping device
- Interchangeable fixtures for high quality marking

#### Characters include:

A	B	C	D	E	F	G	H	I	J	K	L	M	N	O	P	Q	R	S
T	U	V	W	X	Y	Z	&	1	2	3	4	5	6	7	8	9	0	. - /

### Marker Stamp Kit



For marking **PAN-STEEL** stainless steel ties, stainless steel strapping, stainless steel, brass and aluminum marker plates and tags.



Part Number	Description	Pkg. Qty.																																																																																																			
STK12	Marker stamp kit contains (100) character stamps, (1) holder and (1) carrying case. High quality 1/8 in. (3.18 mm) nom. size steel character. Type holder keeps type aligned and provides uniform depth of impression. The holder takes up to 9 characters—1 1/8 in. (28.6 mm) long.  <b>Characters include:</b> <table border="1"> <tr> <td>A</td><td>A</td><td>A</td><td>B</td><td>B</td><td>C</td><td>C</td><td>D</td><td>D</td><td>E</td><td>E</td><td>E</td><td>E</td><td>F</td><td>F</td><td>G</td><td>G</td><td>H</td><td>H</td><td>I</td> </tr> <tr> <td>I</td><td>I</td><td>J</td><td>J</td><td>K</td><td>K</td><td>L</td><td>L</td><td>L</td><td>M</td><td>M</td><td>N</td><td>N</td><td>N</td><td>O</td><td>O</td><td>O</td><td>P</td><td>P</td><td>Q</td> </tr> <tr> <td>R</td><td>R</td><td>R</td><td>S</td><td>S</td><td>S</td><td>T</td><td>T</td><td>U</td><td>U</td><td>V</td><td>W</td><td>W</td><td>X</td><td>X</td><td>Y</td><td>Z</td><td>&amp;</td><td>/</td> </tr> <tr> <td>/</td><td>-</td><td>-</td><td>.</td><td>.</td><td>.</td><td>,</td><td>,</td><td>1</td><td>1</td><td>1</td><td>2</td><td>2</td><td>2</td><td>2</td><td>3</td><td>3</td><td>3</td><td>4</td><td>4</td> </tr> <tr> <td>4</td><td>4</td><td>5</td><td>5</td><td>5</td><td>6</td><td>6</td><td>6</td><td>7</td><td>7</td><td>7</td><td>8</td><td>8</td><td>8</td><td>9</td><td>9</td><td>9</td><td>0</td><td>0</td><td>0</td> </tr> </table>	A	A	A	B	B	C	C	D	D	E	E	E	E	F	F	G	G	H	H	I	I	I	J	J	K	K	L	L	L	M	M	N	N	N	O	O	O	P	P	Q	R	R	R	S	S	S	T	T	U	U	V	W	W	X	X	Y	Z	&	/	/	-	-	.	.	.	,	,	1	1	1	2	2	2	2	3	3	3	4	4	4	4	5	5	5	6	6	6	7	7	7	8	8	8	9	9	9	0	0	0	1
A	A	A	B	B	C	C	D	D	E	E	E	E	F	F	G	G	H	H	I																																																																																		
I	I	J	J	K	K	L	L	L	M	M	N	N	N	O	O	O	P	P	Q																																																																																		
R	R	R	S	S	S	T	T	U	U	V	W	W	X	X	Y	Z	&	/																																																																																			
/	-	-	.	.	.	,	,	1	1	1	2	2	2	2	3	3	3	4	4																																																																																		
4	4	5	5	5	6	6	6	7	7	7	8	8	8	9	9	9	0	0	0																																																																																		
	 <p>The impression is made by hitting the holder with a hammer.</p>																																																																																																				

Order number of Marker Stamp Kits required.

## “S” Hooks and Beaded Chain



“S” Hook

Part Number	Solid Brass “S” Hooks		Pkg. Qty.	Ctn. Qty.
	Overall Length (mm)	Wire Diameter (mm)		
MSH162-C	1 5/8 in. (41.28)	.105 in. (2.67)	100	1000
MSH150-C	1 1/2 in. (38.10)	.105 in. (2.67)	100	1000
MSH125-C	1 1/4 in. (31.75)	.120 in. (3.05)	100	1000

Order number of hooks required in multiples of Pkg. Qty.

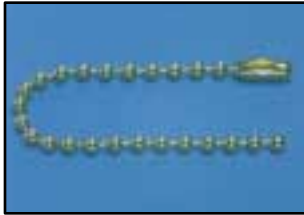

Beaded Chain

Part Number	Description	Pkg. Qty.	Ctn. Qty.
MCB4-C	Solid Brass Chain	100	1000
MCN4-C	Nickel Plated Steel Chain	100	1000
	Extremely flexible 4 1/2 in. (114 mm) bead chain with locking link. (Chain is #6 (3.2 mm) bead diameter)		

Order number of chains required in multiples of Pkg. Qty.

## KP-515 Design Kit



Part Number	Description	Pkg. Qty.
KP-515	<ul style="list-style-type: none"> <li>Convenient and handy plastic kit box. Once closed, parts stay in their compartments.</li> <li>Durable and lightweight</li> <li>Contains:                             <ul style="list-style-type: none"> <li>(100) MLT2S ties</li> <li>(100) MLT2H ties</li> <li>(50) MMP350H marker plates</li> <li>(10) PCSH-5 in. (12.7 cm) length cushion sleeve</li> <li>(10) PSSH-5 in. (12.7 cm) length cushion sleeve</li> <li>(1) HTMT installation tool</li> <li>(1) K-505 plastic kit box</li> </ul> </li> </ul>	1

Order the number of kits required.

Includes **PAN-STEEL™** cable ties, marker plates, HTMT installation tool and plastic box.

Perfect for prototyping.



## MTM1H Stainless Steel Mount



Part Number	Used with PAN-STEEL Ties/Strapping	Mounting Method	Dimensions in. (mm)				Pkg. Qty.	Ctn. Qty.
			A	W	H	Z		
<b>MTM1H-C</b>	MLT-S/H, MS375, or MSC375	#8 (4 mm) Screw	.90 (22.6)	.40 (10.2)	.17 (4.37)	.176 (4.4)	100	1000
<b>MTM1H10-C</b>		#10 (5 mm) Screw				.214 (5.4)		
MTM1H25-C		1/4 in. (6 mm) Screw				.281 (7.1)		

Provides an entire stainless steel attachment when used with **PANDUIT PAN-STEEL™** steel ties or strapping. The mount has a very low profile to attach cables or bundles at minimum height, and utilizes only one hole for mounting.

Material: 304 stainless steel. Consult factory for additional materials.

Order number of mounts required in multiples of Pkg. Qty.  
Stainless steel screws are recommended for fastening to avoid corrosion problems associated with dissimilar metals.

### Features:

- Low profile
- One hole mounting

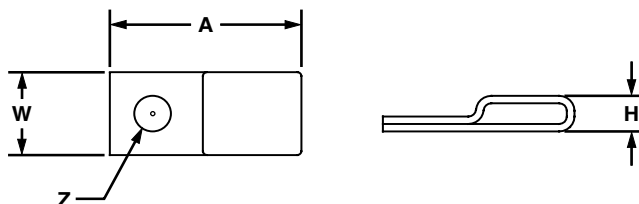

## Stainless Steel Push Mount



Push-wing mount is used to secure wires and cables in pre-drilled panels, cabinets, or frames. Can be used when only one side of the panel is accessible. The mount is inserted into a pre-drilled hole and locks in place which speeds installation due to the

elimination of a screw.

Material: 304 stainless steel. Consult factory for additional materials.

Part Number	Used with PAN-STEEL Ties	Mounting Method	Dimensions in. (mm)				Panel Thickness in. (mm)	Pkg. Qty.	Ctn. Qty.
			A	W	H	P			
MPWM-H56-Q	MLT-S/H	Inserted into pre-drilled hole 5/16 in. (8 mm)	.98 (24.7)	.29 (7.3)	.56 (14.2)	.34 (8.5)	.031 (0.8) - .094 (2.4)	25	250

Order number of mounts required in multiples of Pkg. Qty.

### Features:

- No tapping required
- Used where only one side of the panel is accessible
- Nothing to assemble

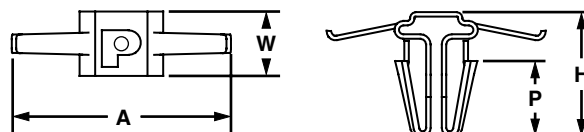

## Stainless Steel Push-Button Mount



Push-button mount is used to secure wires and cables in pre-drilled panels, cabinets, or

frames that have access from both sides. Mount is inserted into a pre-drilled hole and locks in place which provides a low profile stainless steel attachment when used with a stainless steel cable tie.

Material: 304 stainless steel. Consult factory for additional materials.

Part Number	Use with PAN-STEEL Ties	Mounting Method	Dimensions in. (mm)			Panel Thickness in. (mm)	Pkg. Qty.	Ctn. Qty.
			A	W	H			
MBM-H25-Q	MLT-S	Inserted into pre-drilled hole .250 in. (6.4 mm)	.40 (10.0)	.20 (5.0)	.26 (6.5)	.031 (0.8) - .125 (3.2)	25	250

Order number of mounts required in multiples of Pkg. Qty.

### Features:

- Low profile
- No tapping required
- Designed for use only where both sides of the panel are accessible

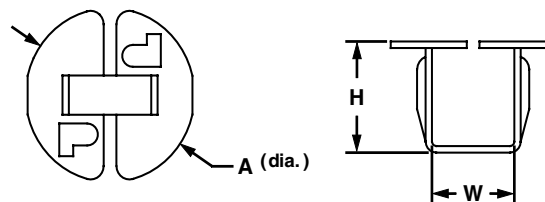

## Stainless Steel 2-Way Mount

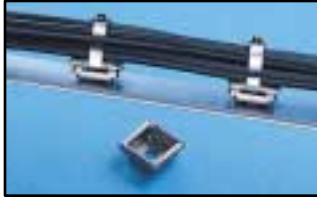

Part Number	Used with PAN-STEEL Ties	Dimensions in. (mm)					Mounting Method in. (mm)	Pkg. Qty.	Ctn. Qty.
		A	G	H	Q	Z			
MTM2H-Q	MLT-S/H	.71 (18.0)	.09 (2.3)	.30 (8.0)	.35 (9.0)	.176 (4.5)	#8 (4) screw	25	250

Order number of mounts required in multiples of Pkg. Qty.  
Stainless Steel screws are recommended for fastening to avoid corrosion problems associated with dissimilar metals.

- Two-way mount allows stainless steel cable ties to be inserted from either of two sides, providing a low profile attachment with only (1) -hole for maximum holding and stability.
- Material: 304 stainless steel. Consult factory for additional materials.

### Features:

- Low profile
- Single hole center mounting for maximum holding and stability
- Maximum screw head height .09 (2.3 mm)

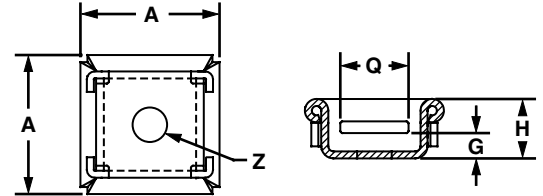

## Stainless Steel Bulkhead Mount

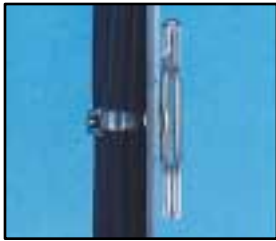

Part Number	Used with PAN-STEEL Ties	Dimensions in. (mm)			Mounting Method in. (mm)	Panel Thickness in. (mm)	Pkg. Qty.	Ctn. Qty.
		A	W	H				
MTMBH-Q	MLT-S/H	1.92 (48.5)	.21 (5.3)	.54 (13.7)	Pre-drill hole size Standard cross section MLT-S .375 (9.5) – .500 (12.7) Hvy. cross section MLT-H .500 (12.7) – .625 (15.9)	Up to max. .500 (12.7)	25	250

Order number of mounts required in multiples of Pkg. Qty.

- Bulkhead mount is used to secure cables, wires, and hoses to metal framework of trucks, automobiles, control panels, and equipment where one side of the hole is accessible.
- Material: 304 stainless steel. Consult factory for additional materials.

### Features:

- Zero profile
- Mounts directly to surface
- Used where only one side of the panel is accessible
- Permanent, secure application

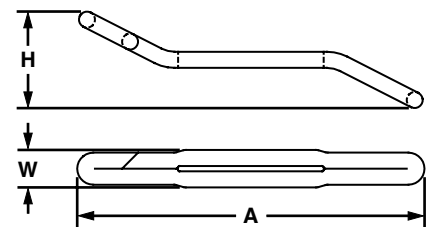

## Telecommunications Installation Products

### Stackable Cable Spacers



**PANDUIT** Cable Ties and Spacers are used to separate the support strand from the cable or to separate two cables in aerial lashing applications. The cable ties are available in stainless steel and different types of nylon to meet various environmental conditions. Some nylon cable ties are releasable (type PRT) after installation, which means they can be removed and reused during cable modifications.



Stackable Spacers, SAC S5-T100 and  
Stainless Ties, MLT4H-LP

### Stackable Cable Spacer

Just one part to inventory. Each spacer snaps by hand into another—increase spacer height by 1/2 in. (12.7 mm) increments. Because there is only one part, on-site sorting is eliminated. Can be used with up to 3/4 in. (19 mm) width (B or C lashed cable supports) in parallel or perpendicular applications.



Part Number	Used With Cable Ties	Dimensions in. (mm)	Material	Color	Where Used	Mounting Methods	Pkg. Qty.	Ctn. Qty.
<b>SACS50-T100</b>	▲ See footnote	2.08 X 1.16 (52.8 X 21.5)	Weather Resistant Polypropylene	Black	Outdoors	Cable Ties	200	2000

Order number of spacers required in multiples of Pkg. Qty.

▲ Stackable spacers may be installed using weather resistant Lashing Ties, weather resistant Light and Heavy Cable Ties, **DURA-TY**™ Cable Ties (see Catalog Cable Ties & Wiring Accessories SA101N275C-WC) and stainless steel cable ties (see [page 4](#)).

## Telecommunications Installation Products (Cont.)

### Stackable Cable Spacers Overview

#### Application Features

##### AERIAL CABLE LASH SUPPORTS

**PANDUIT PAN-STEEL™** Stainless Steel Ties are used to fasten cable and/or splice closures to the messenger strand.

##### FEATURES OF PAN-STEEL STAINLESS STEEL TIES

- High Strength
- Long Life
- Weather Resistance
- Chemical Resistance

##### ADVANTAGES

- +40 years life
- Unaffected by sun, acid rain or most chemicals
- Up to 250 lbs. minimum loop tensile strength
- Single wrap, self locking design

##### BENEFITS

- Reduced need for periodic rework
- Allows ties to be used in many different conditions
- Strong for use in rugged applications
- Fast and as easy to install as cable ties
- Saves time and lowers installed cost
- Safe to use; will not injure installer's hands or abrade cable insulation

#### Typical Aerial Lashing Installations

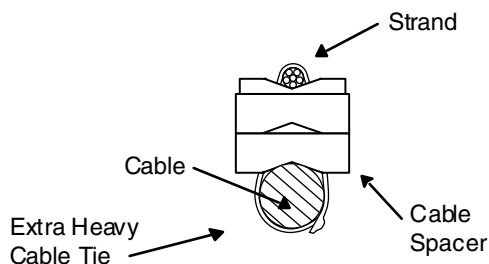
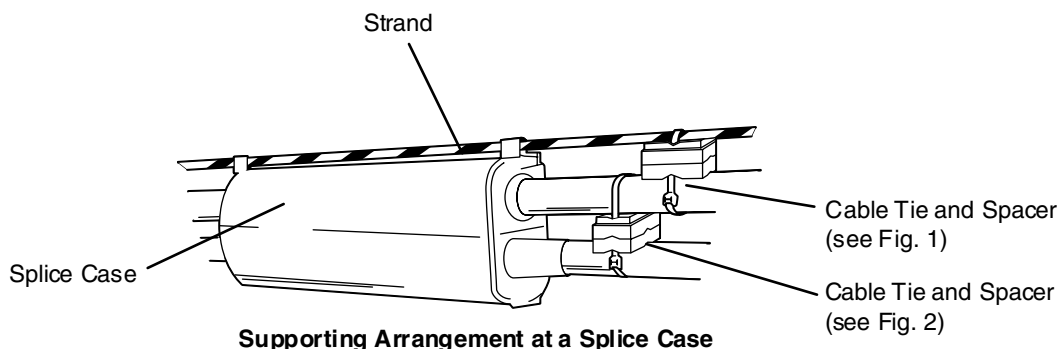

**Fig. 1**  
**Cable Tie Cable Spacer**  
**Installed on Cable and Support Strand**

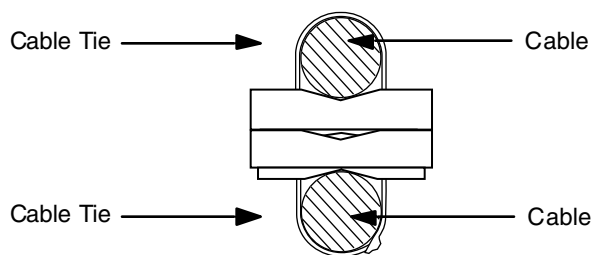

**Fig. 2**  
**Cable Tie Cable Spacer**  
**For Larger Cables**

# PANDUIT® Stainless Steel Tie Technical Data

## Physical Characteristics of Stainless Steel Cable Ties (MLT Series)

PAN-STEEL™ Design Criteria	Stainless Steel
Tensile Strength 73° F (23° C)	90,000 <sup>1</sup>
Color	Stainless
Flammability	Non-flammable
Radiation Resistance	2 X 10 <sup>8</sup> Rads
Water Absorption (24 hours)	None
Ultraviolet Light Resistance	Excellent

1 - ASTM E8 Test Method

PAN-STEEL Design Criteria	Stainless Steel
Max. Continuous Use Temperature	1000° F (538° C) for 304 & 316 material and 1700° F (925° C) for 321 material
Min. Continuous Use Temperature	-112° F (-80° C) for 304, 316 & 321
Loop Tensile Strength @ 120° F (49° C) 20% RH	Standard 100 lbs. (445 N) Hvy. 250 lbs. (1112 N)
Installation Tools	PPTMT, GS4MT, ST2MT and HTMT

## PANDUIT Stainless Steel Cable Tie and Strapping Approvals (At time of printing)

AGENCY	SPEC/ APPROVAL	REQUIREMENT	APPLICABLE PRODUCTS	AGENCY	SPEC/ APPROVAL	REQUIREMENT	APPLICABLE PRODUCTS
US MIL	MS23109E	Dimensional, visual, vibration, temp. cycling, immersion, melting point.	MLT-S Series: standard cross section ties.	Underwriters Laboratories	E56854	Dimensional, tensile, temp., cycling, humidity.	All MLT ties.
Det Norske Veritas	Cert. #E-1630 E-1629	Salt mist test, tensile test, accelerated aging, vibration tests.	All MLT & MS ties and straps in 316 material.	Germanischer Lloyd	Cert. # 32666HH	Mechanical	All MLT ties.
Amer. Bureau of Shipping	Cert. # 99-CH18282-X	Mechanical	All MLT ties.	US Coast Guard	File No. 16703/46-113	Mechanical	All MLT ties.
Lloyd's Register of Shipping	Cert. # 89/0123	Material specification, tensile test, vibration tests.	All MLT & MS ties and straps in both 302/304 and 316 material.	State Electricity Commission of Victoria	Reference File LA 79402	Mechanical	Various MLT 302/304 cable ties.
Bureau Veritas	Approval # 2535/4048/A0/0	Material specification, dimensional, visual.	All 316 grade MLT cable ties, both standard and heavy cross section.	Australian Standard	AS3013	Fire, mechanical and water tests.	All MLT and MS straps.
				US Military	MIL-T-81306A MS90387-3	Mechanical	GS4MT Installation tools.
				Registro Italiano Novale	5/014/92	Mechanical	All MLT ties

## Rigorous Tests and Physical Properties of Stainless Steel Ties

### STRENGTH

PANDUIT PAN-STEEL Stainless Steel Ties are tested per the U.S. Military Specification MIL-S-23190, minimum loop tensile test. This test consists of applying a tie to a split mandrel and then measuring the force required to separate the (2) halves until the tie fails. These minimum loop tensile strengths are given for the various loop products on [pages 4 and 5](#).

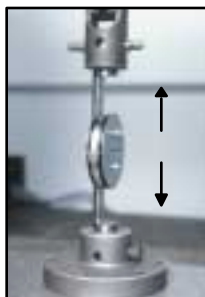

PAN-STEEL MLT Part Series	Minimum Loop Tensile Strength
Standard Hvy.	100 lbs. (445 N) 250 lbs. (1112 N)
(MLT) W	200 lbs. (890 N)
(MLTC) Hvy.	120 lbs. (534 N)
(MLTDH) Hvy.	600 lbs. (2669 N)

### TEMPERATURE EXTREMES

PANDUIT PAN-STEEL Stainless Steel Ties are 100% stainless steel in the alloy provided (Locking head, locking ball and body all provided from the same grade of material ordered.)

Temperature Ranges for Stainless Steel	
Type 304	-112°F(-80°C) to 1000°F(538°C)
Type 316	-112°F(-80°C) to 1000°F(538°C)
Type 321	-112°F(-80°C) to 1700°F(925°C)

Various temperature tests have been successfully completed. One such test is the U.S. Military Temperature Cycling Test per Thermal Shock Method 107, Test Condition B of MIL-STD-202F. This test exposes the parts from low temperature -85° F (-65° C) to high temperature 275° F (135° C) to low temperature -85° F (-65° C). After exposure, the parts must be free of cracks, distortions, breaks, release of locking device, and meet the minimum loop tensile requirements.

### MILITARY CROSS REFERENCE (MIL-S-23190E)

PANDUIT Part Number	Current Military Standard Part Number
MLT2S-CP	M23190/3-1
MLT2S-CP316	M23190/3-1
MLT4S-CP	M23190/3-2
MLT4S-CP316	M23190/3-2
MLT6S-CP	M23190/3-3
MLT6S-CP316	M23190/3-3
MLT8S-CP	M23190/3-4
MLT8S-CP316	M23190/3-4

## Rigorous Tests and Physical Properties of Stainless Steel Ties (cont.)

### VIBRATION

**PANDUIT PAN-STEEL™** Standard Cross Section ties have passed the U.S. Military random vibration Test Method 214, Test Condition II, Letter J of MIL-STD-202. This test consists of applying parts to a bundle and then vibrating them with random vibration for 8 hours in each of two mutually perpendicular directions. The parts are then subjected to further temperature testing and finally have to pass the minimum loop tensile strength test.

### SALT SPRAY

**PANDUIT PAN-STEEL** Stainless Steel Ties have been subjected to salt spray tests lasting hours without signs of corrosion or reduction in performance.

### OUTDOOR EXPOSURE

**PANDUIT PAN-STEEL** Stainless Steel Ties have been exposed outdoors at New Lenox Illinois, USA since 1985. At the printing of this catalog, there has been no sign of corrosion or loss of performance.

### FLUID IMMERSION

**PANDUIT PAN-STEEL** Stainless Steel Ties were immersed in: 1–Hydraulic Fluid, 2–Turbine Fuel, 3–Lubricating Oil, and 4–Isopropyl Alcohol for (4) hours at temperatures of 122° F (50° C). Per U.S. Military Specification MIL-S-23190E, the parts were then subjected to and passed the minimum loop tensile test.

### RADIATION

Installed cable ties of various materials have been exposed to different amounts of radiation to determine the maximum acceptable limit. These tests were conducted by **PANDUIT** to determine the acceptability for use in various areas of nuclear power plants (accumulated over 40 year life). Radiation resistance is 2X10<sup>8</sup> rads.

## Chemical Resistance at 70°F (21°C) Temperature

Chemical	%	304 & 316 Stainless Steel	Chemical	%	304 & 316 Stainless Steel	Chemical	%	304 & 316 Stainless Steel	Chemical	%	304 & 316 Stainless Steel
Arsenic Acid	40	E	Cider		E	Methyl Alcohol	100	E	Sodium Bisulfate	10	E
Acetone	100	E	Diethyl Chloroethane	100	E	Methyl Chloride	100	E	Sodium Borate	All	E
Aluminum Hydroxide	AQ C.S.	E	Diethyl Ether	100	E	Methyl Ethyl Ketone	100	E	Sodium Carbonate	5	E
Ammonium Carbonate	5	E	Ethyl Alcohol	100	E	Naphtha	100	E	Sodium Chlorate	25	E
Ammonium Hydroxide	10	E	Ethyl Chloride	100	E	Nitric Acid	30-70	E	Sodium Chloride	2	E
Ammonium Nitrate		E	Ethyl Glycol	100	E	Nitrous Acid	5	E	Sodium Fluoride	5	F
Ammonium Sulfate	10	S	Ferric Hydroxide	All	E	Oleic Acid	100	E	Sodium Hydroxide	10	E
Barium Carbonate	All	E	Ferric Nitrate	10	E	Oxalic Acid	10	E	Sodium Hyposulfite	AQ C.S.	E
Barium Chloride	5	E	Ferrous Sulfate	10	E	Paraffin	100	E	Sodium Nitrate	5	E
Barium Sulfate	10	E	Fuel Oil	100	E	Petroleum Ether	100	E	Sodium Nitrite	AQ C.S.	E
Barium Sulfide	10	E	Furfural	100	E	Phenol	90	E	Sodium Perchlorate	10	E
Benzene	100	E	Gallic Acid	AQ C.S.	E	Phosphoric Acid	10	E	Sodium Phosphate	5	E
Benzoic Acid	100	E	Gasoline	100	E	Picric Acid	1	S	Sodium Sulfate	5	E
Butyric Acid	50	E	Glycerine	100	E	Potassium Bromide	AQ C.S.	S	Sodium Thio sulfate	5	S
Calcium Carbonate	AQ C.S.	E	Hydrocyanic Acid	All	E	Potassium Carbonate 1%		E	Stearic Acid	100	E
Calcium Chlorate	10	E	Hydrogen Peroxide	30	E	Potassium Chlorate	AQ C.S.	E	Sulfur	100	E
Calcium Hydroxide	20	E	Hydrogen Sulfide	Dry	E	Potassium Dichromate	40	E	Sulfur Dioxide	All	E
Calcium Hydrochlorite	2	F	Idoform	100	E	Potassium Ferrocyanide	25	E	Sulfuric Acid	100	E
Calcium Sulfate	2	E	Isopropyl Alcohol	100	E	Potassium Hydroxide	5	E	Sulfuric Acid	5	F
Carbon Tetrachloride			Jet Fuel	100	E	Potassium Iodide	All	E	Tannic Acid	10	E
Chlorine (Wet)		F	Lactic Acid	100	E	Potassium Nitrate	50	E	Tartaric Acid	50	E
Chlorine (Dry)		F	Lanolin	10	E	Potassium Permanganate	5	E	Tetrahydrofuran	100	E
Chloroacetic Acid	30	F	Lead Acetate	5	E	Potassium Sulfate	5	E	Toluene	100	F
Chloroform	100	E	Magnesium Carbonate	All	E	Potassium Sulfide	AQ C.S.	E	Xylene	100	E
Chromic Acid	5	E	Magnesium Chloride	10	F	Propyl Alcohol	100	E	Zinc Chloride	70	E
Citric Acid	50	E	Magnesium Nitrate	All	E	Silver Nitrate	10	E	Zinc Nitrate	AQ C.S.	E
Copper Cyanide	10	E	Malic Acid	AQ C.S.	E	Sodium Acetate	60	E	Zinc Sulfate	AQ C.S.	E
Copper Nitrate	50	E	Mercury	100	E	Sodium Bicarbonate	All	E			

E = Excellent S = Satisfactory F = Fair AQ C.S. = Aqueous Cold Saturated All = All % Concentrations

# PANDUIT® Stainless Steel Strapping System

## PANDUIT PAN-STEEL™ Stainless Steel Strapping System



The **PANDUIT PAN-STEEL** stainless steel strapping system reduces installation time and leaves no sharp edges.

- 3 widths available: 3/8 in. (9.5 mm), 1/2 in. (12.7 mm), and 5/8 in. (15.9 mm)
- Burr-free sides
- Non-magnetic 304 stainless steel
- Designed for use in critical applications where radiation, weathering, corrosion, and temperature extremes are a concern
- Temperature range: -112° F (-80° C) to 1000° F (538° C)
- Fast and reliable alternative to wing seals

### Unique Patented Locking Method

Buckle design provides a low finished profile



After tensioning, cut end is locked inside buckle—no exposed sharp edge

### The PANDUIT Method Reduces Installation Time



1. Place strap around the material, insert tail of strap through buckle. Pull strapping tight and bend up to hold in place. Insert tail of strapping into tool nose section. Squeeze handles to tension.



2. Once proper tension is reached, maintain tension and raise tool 90° - 120° over buckle and turn parallel with the bundle, cutting strap. Remove tool, press cut end down and toward retaining tab.



3. Using the closure lever on the handle of the tool, bend retaining tab down and over cut end. Provides finished, safe, low profile closure.

### Part Number System Example

(Stock Size Straps)

MS Part Description	8 X Bundle Diameter Reference	375 X 15 Cross Section	L Package Qty.	S Material
Metal Strapping		375 X 15 = .375 in. (9.5mm) X .015 in. (0.38mm)	L = 50	S = 304 Stainless Steel
		500 X 15 = .500 in. (12.7mm) X .015 in. (0.38mm)		
		500 X 20 = .500 in. (12.7mm) X .020 in. (0.51mm)		
		625 X 15 = .625 in. (15.9mm) X .015 in. (0.38mm)		

# PANDUIT® Stainless Steel Strapping System

## PAN-STEEL™ Stainless Steel Strapping



Stock sizes of pre-assembled incremental length product available for outside bundle diameters from 1.50 in. (38.1 mm) up to 10 in. (254 mm).

Material: AISI 304 non-magnetic stainless steel.

AISI 316 material available upon request. Contact factory for details.

Part Number	Thickness in. (mm)	Width in. (mm)	Min. Loop Tensile Strength lbs. (N)	Max. Bundle Dia. in. (mm)	Length in. (mm)	Recommended PANDUIT Installation Tool Part No.	Pkg. Qty.	Ctn. Qty.
MS2X375X15-LS MS4X375X15-LS MS6X375X15-LS MS8X375X15-LS MS10X375X15-LS	.015 (0.38)	.375 (9.5)	300 (1335)	2.00 (51) 4.00 (101) 6.00 (152) 8.00 (203) 10.00 (254)	10.2 (266) 16.2 (411) 22.5 (571) 28.7 (721) 35.0 (889)	BT2MS75	50 50 50 50 50	250 250 250 250 250
<b>MS4X500X15-LS</b> <b>MS6X500X15-LS</b> MS8X500X15-LS MS10X500X15-LS	.015 (0.38)	.500 (12.7)	500 (2224)	4.00 (101) 6.00 (152) 8.00 (203) 10.00 (254)	16.2 (411) 22.5 (571) 28.7 (729) 35.0 (889)	BT2MS75	50 50 50 50	250 250 250 250
MS4X625X15-LS MS6X625X15-LS MS8X625X15-LS MS10X625X15-LS	.015 (0.38)	.625 (15.9)	600 (2670)	4.00 (101) 6.00 (152) 8.00 (203) 10.00 (254)	16.2 (411) 22.5 (571) 28.7 (729) 35.0 (889)	BT2MS75	50 50 50 50	250 250 250 250
MS4X500X20-LS MS6X500X20-LS MS8X500X20-LS MS10X500X20-LS	.020 (0.51)	.500 (12.7)	500 (2224)	4.00 (101) 6.00 (152) 8.00 (203) 10.00 (254)	16.2 (411) 22.5 (571) 28.7 (729) 35.0 (889)	BT2MS75	50 50 50 50	250 250 250 250

Order number of straps required in multiples of Pkg. Qty.

### Features:

- Buckle design provides a low finished profile.
- After tensioning, cut end is locked inside buckle—no sharp edges.
- Buckle locked in place—won't slip down strap.

## Custom Length Strapping System



For applications that require various bundle diameters or outside bundle diameters larger than 10 in. (254 mm). Supplied in reels of 200 ft. (61 m), lets you bundle any size diameter. To use, pull out as much as needed, cut off with shears and install with MSB buckle. The buckle is installed by taking one end of cut strapping and bending it back 1/2 in. (13 mm). Take a buckle and slide it the entire length of strap until it reaches the bend. Bend tail flat against bottom of strapping head to complete assembly. The system provides job-site versatility with minimum inventory.

Standard Material: AISI 304 non-magnetic stainless steel AISI 316 material available upon request. Contact factory for details. Minimum bundle diameter 1.50 in. (38 mm).

Part Number	Thickness in. (mm)	Width in. (mm)	Used with Buckle	Recommended Tool Part No.	Pkg. Qty.
MS375X15-TSR <b>MS500X15-TSR</b> MS500X20-TSR MS625X15-TSR	.015 (0.38) .015 (0.38) .020 (0.51) .015 (0.38)	.375 (9.5) .500 (12.7) .500 (12.7) .625 (15.9)	MSB375 MSB500 MSB500 MSB625	BT2MS75	200 ft. (61 m) 200 ft. (61 m) 200 ft. (61 m) 200 ft. (61 m)

Order number of reels required.

Part Number	Description	Pkg. Qty.	Ctn. Qty.
MSB375-CS <b>MSB500-CS</b> <b>MSB625-CS</b>	Individual low profile buckles. To use, slip buckle onto strapping; turn back extended back approximately .500 in. (13 mm) to hold in place. To determine length of strapping to use: Calculate diameter X 3.14 + 3.50 in. (89 mm). Example: 14 in. (350 mm) diameter 14 in. (350 mm) X 3.14 = 44 in. (1099 mm) + 3.50 in. (89 mm) = 47.50 in. (1188 mm) of strapping required.	100 100 100	1000 1000 1000



MSB Buckle

Order number of buckles required in multiples of Pkg. Qty.



# PANDUIT® Nylon Coated Stainless Steel Strapping System

## PAN-STEEL™ Coated Stainless Steel Strapping

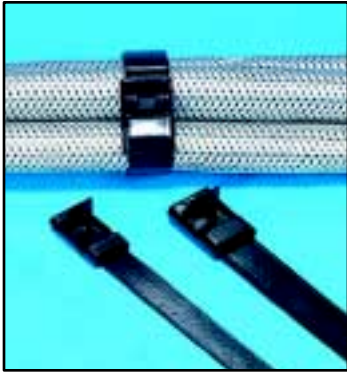

Nylon coated straps for use in applications where:

- Additional protection is required to prevent any sharp edges
- Standard base material: AISI 316 stainless steel, non-magnetic

Part Number (Stock Sizes)	Strap Thickness* in. (mm)	Min. Loop Tensile Strength Lbs. (N)	Max. Bundle Dia. in. (mm)	Length in. (mm)	Width in. (mm)	Recommended PANDUIT Installation Tool No.	Pkg. Qty.	Ctn. Qty.
MSC2X375-LS1 MSC4X375-LS1 MSC6X375-LS1 MSC8X375-LS1	.015(0.38)	300 (1335)	2.00 (50) 4.00 (101) 6.00 (152) 8.00 (203)	10.48 (266) 16.18 (411) 22.47 (571) 28.75 (730)	.375 (9.5)	BT2MS75	50	250
MSC2X500-LS1 MSC4X500-LS1 MSC6X500-LS1 MSC8X500-LS1	.015(0.38)	500 (2224)	2.00 (50) 4.00 (101) 6.00 (152) 8.00 (203)	10.48 (266) 16.18 (411) 22.47 (571) 28.75 (730)	.500 (12.7)	BT2MS75	50	250
MSC2X625-LS1 MSC4X625-LS1 MSC6X625-LS1 MSC8X625-LS1	.015(0.38)	600 (2670)	2.00 (50) 4.00 (101) 6.00 (152) 8.00 (203)	10.48 (266) 16.18 (411) 22.47 (571) 28.75 (730)	.625 (15.9)	BT2MS75	50	250

\*Base material before coating  
Order number of straps required, in multiples of Pkg. Qty.

### Features:

- After tensioning cut end is locked inside buckle - no exposed sharp edge
- Buckle locked in place - won't slip down strap

### Nylon 11 Coating

- 100% coated with Black Nylon 11, coating thickness .003 in. (0.07mm) / .005 in. (0.13mm) per side
- Halogen-free with good self-extinguishing properties
- Good in applications at temperatures down to -40°F (-40°C)
- Excellent resistance to chemicals and salt sprays
- Upper temperature limit 285°F (140°C)

## Installation Tool for Strapping (MS Series)

### BT2MS75



Hand Operated Tool. Installer controlled tension and cut-off.

Part Number	Description	Pkg. Qty.
<b>BT2MS75</b>	Installation tool. Used for all widths of <b>PANDUIT PAN-STEEL</b> strapping. <ul style="list-style-type: none"> <li>• Durable tool tensions, cuts strapping, and secures the buckle tab.</li> <li>• Narrow, lightweight—allows one hand operation in otherwise difficult areas to install.</li> <li>• Pliers-type tool provides mechanical advantage for tensioning.</li> <li>• Easy to operate.</li> </ul>	1
BT2N75	Replacement nose section for BT2MS75 tool. <ul style="list-style-type: none"> <li>• Provides the economy of repair vs. total tool replacement.</li> <li>• Easy to install on tool.</li> </ul>	1
KT2MG	Replacement tension gripper for BTMS75 tool. <ul style="list-style-type: none"> <li>• Easy to install on tool.</li> </ul>	1

Order number of pieces required.

### Features:

- Strap side entry (See photo)
- One hand tensioning and cut-off operation - lightweight
- Installer controlled tension
- Cut-off with the twist of the wrist
- Easy removal of excess strap
- Installs all (3) sizes: 3/8 in. (9.5mm), 1/2 in. (12.7mm), and 5/8 in. (15.9mm)

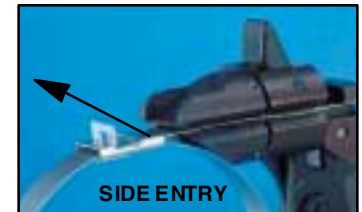

## PANDUIT PAN-STEEL Applications

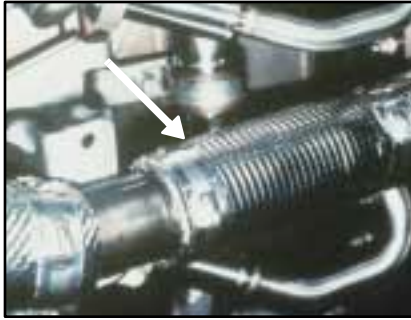

### AIRCRAFT

*PANDUIT PAN-STEEL* Type MLT Stainless Steel Ties are used to fasten thermal insulation blankets to jet engine manifolds and tubes.

### PRIMARY BENEFIT

Installation tooling with controlled tension and auto cut-off capability (PPTMT & GS4MT) significantly reduces cost of installation and the low weight, high strength of the ties makes them more efficient and reliable than conventional fasteners. The stainless steel ties have been temperature tested to over 1000° F (538° C) to provide excellent continuous service over the entire temperature range and to provide long life.

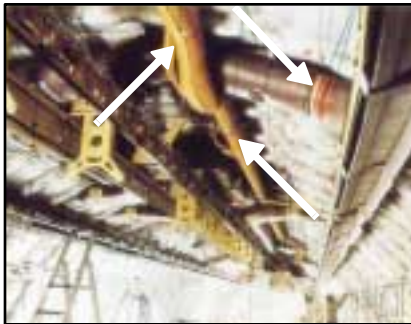

### AIRCRAFT

*PANDUIT PAN-STEEL* Stainless Steel Ties are used to secure insulation envelopes to ducting in aircraft fuselages.

### PRIMARY BENEFIT

The ties have been tested to over 1000° F (538° C) which provides excellent continuous service over the entire operating range and the single wrap, self-locking low weight design provides improved efficiency and reliability.



### TRUCK ENGINES

*PANDUIT PAN-STEEL* Stainless Steel Ties are used to fasten thermal insulation blankets to truck engine exhaust pipes.

### PRIMARY BENEFIT

The ties provide high strength, low profile and low weight design which are more efficient than conventional fasteners and are temperature tested to over 1000° F (538° C) for performance under continuous high temperature conditions.



### AUTOMOTIVE

*PANDUIT PAN-STEEL* Ties are used to fasten constant velocity (CV) boots on front wheel drive automobiles.

### PRIMARY BENEFIT

The ties can be installed without disassembling the constant velocity (CV) joint which saves installation time and lowers installed costs. The stainless steel ties provide excellent weather resistance and corrosion resistance for long life with high strength and low weight.



### TELECOMMUNICATIONS

*PANDUIT PAN-STEEL* Ties are used to securely fasten cables to telecommunication towers.

### PRIMARY BENEFIT

The ties provide long life, corrosion and chemical resistance in harsh environments and temperature extremes. The self-locking design provides fast and easy installation, state-of-the-art tooling further reduces installation time.