



Chipsmall Limited consists of a professional team with an average of over 10 year of expertise in the distribution of electronic components. Based in Hongkong, we have already established firm and mutual-benefit business relationships with customers from,Europe,America and south Asia,supplying obsolete and hard-to-find components to meet their specific needs.

With the principle of “Quality Parts,Customers Priority,Honest Operation,and Considerate Service”,our business mainly focus on the distribution of electronic components. Line cards we deal with include Microchip,ALPS,ROHM,Xilinx,Pulse,ON,Everlight and Freescale. Main products comprise IC,Modules,Potentiometer,IC Socket,Relay,Connector.Our parts cover such applications as commercial,industrial, and automotives areas.

We are looking forward to setting up business relationship with you and hope to provide you with the best service and solution. Let us make a better world for our industry!



Contact us

Tel: +86-755-8981 8866 Fax: +86-755-8427 6832

Email & Skype: info@chipsmall.com Web: www.chipsmall.com

Address: A1208, Overseas Decoration Building, #122 Zhenhua RD., Futian, Shenzhen, China



ANTENNA SELECTION GUIDE FOR THE 868 MHz EZRADIO® AND EZRADIOPRO® DESIGNS

1. Introduction

This document describes the nine different 50 Ω single-ended antenna types used in the easy-to-use 868 MHz Antenna Matrix (WES0030-01-AMS868-01), which is dedicated to the EZRadio and EZRadioPRO family. Using the development tool, the reader can test the performance of the Silicon Labs' RFIC radio family with different types of antennas and then find the best solution for the application in terms of shape, size, cost, and expected range.

The antenna types in the matrix are selected for the most common application areas in the 868 MHz band. The antennas are optimized and tuned for the antenna PCB + Pico Board + Motherboard (MSC-WMB930 Wireless Motherboard) structure (see Figure 1).

The input impedance, radiation pattern, and antenna gain of every antenna type in the Matrix are measured with the above configuration. The outdoor range is also checked using two identical antenna modules at the two sides of the link. The results are given in a separate document containing measurement reports for each antenna type.

In typical customer cases the antennas are applied without the nearby Pico Board and Motherboard, and therefore their effects disappear. Since all customer applications are different, the right solution may not be found among these fixed size, fixed form factor Matrix antennas.

For these outlying cases, Silicon Labs recommends the user modify/tune the printed ILA (Inverted L Antenna) and IFA (Inverted F Antenna) types, which are customizable in terms of length and performance. Silicon Labs provides an easy-to-understand, simple, step-by-step tuning process description in the Application Note entitled "Antenna Design Guide for Single-Ended 50 Ω Antennas". Use this Application Note to customize and optimize the performance of these antennas.

The current Matrix is designed for 50 Ω single-ended solutions. Another matrix will be devoted to the differential, high-impedance antennas, which are supported by the Si4010 /12/ RF IC family.

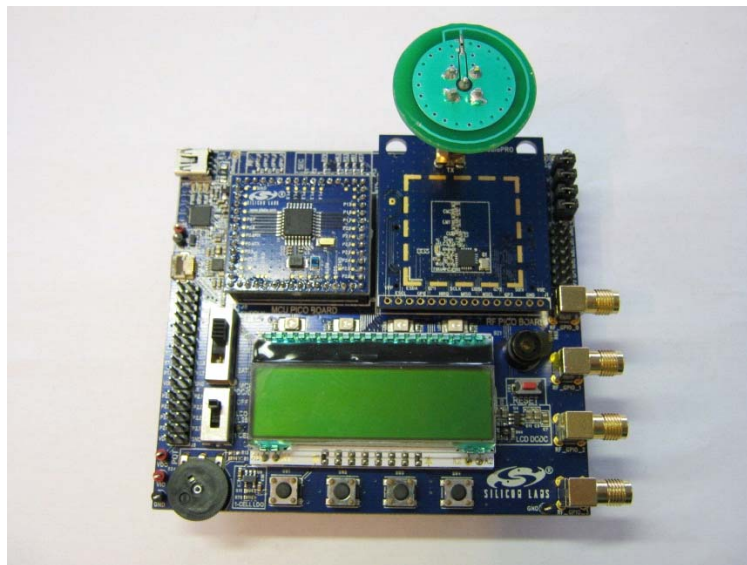

Figure 1. Typical Measurement Configuration—Antenna Board, Pico Board, and Wireless Motherboard

2. General Notes

The following apply.

- EZRadio and EZRadioPRO family of products are supported
- RF Pico Boards equipped with Si4x55, Si4456, or Si446x can be used with these antennas
- RF connectors are matched to 50 Ω
- Boards are equipped with female SMA connectors
 - Antenna can be connected to the Pico Board using an SMA male-to-male straight adapter
- MSC-WMB930 Wireless Motherboard serves as the driving interface of the Pico Board (Figure 1)
- 41 mm wide Pico Boards -> max. 41 mm wide antenna panels
- All PCB antennas are designed on 1.55 mm thick FR4 substrate

3. Antenna Type Description and Typical Applications

The PCB plot of the WES0030-01-AMS868-01 868 MHz Antenna Matrix is shown in Figure 2. For the 868 MHz band nine different PCB antenna solutions are proposed:

- Medium Size Printed ILA (or optionally IFA) around the PCB circumference (WES0031-01-APL868M-01)
- Ceramic (Chip) Antenna (WES0032-01-ACM868D-01)
- Small Size (Wire) Helical Antenna (WES0033-01-AWH868S-01)
- Medium Size (Wire) Helical Antenna (WES0034-01-AWH868M-01)
- Panic Button ILA (Printed) along the circumference (WES0035-01-APF868P-01)
- Panic Button IFA (Printed) along the circumference (WES0036-01-APL868P-01)
- Printed Meander Monopole (WES0037-01-APN868D-01)
- Small Size Printed ILA (or optional IFA) in dedicated small antenna area (WES0038-01-APL868S-01)
- Printed BIFA in a dedicated bigger antenna area (WES0039-01-APB868D-01)

The position of the antennas within the Antenna Matrix is shown in Figure 3.

In addition to testing the range of the antennas in the antenna matrix, the range is also tested using a commercially available external whip reference antenna.

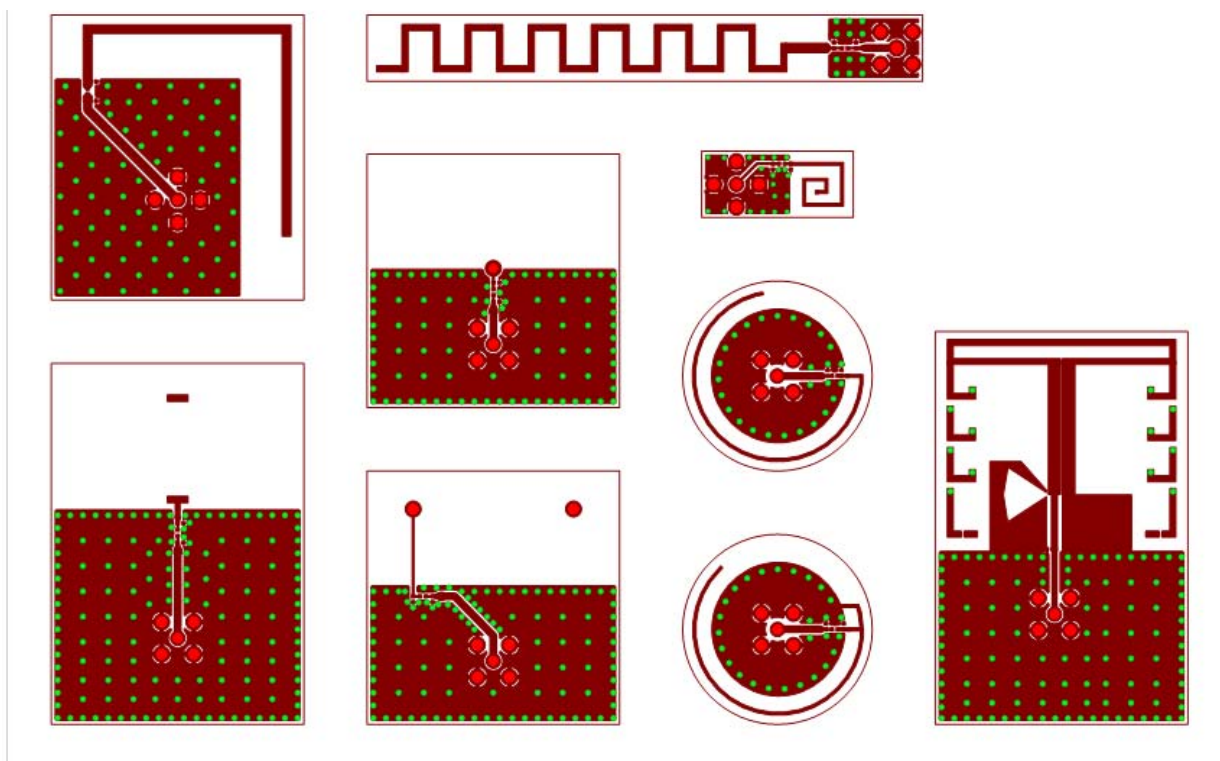

Figure 2. PCB Plot WES0030-01-AMS868-01 868-MHz Antenna Matrix

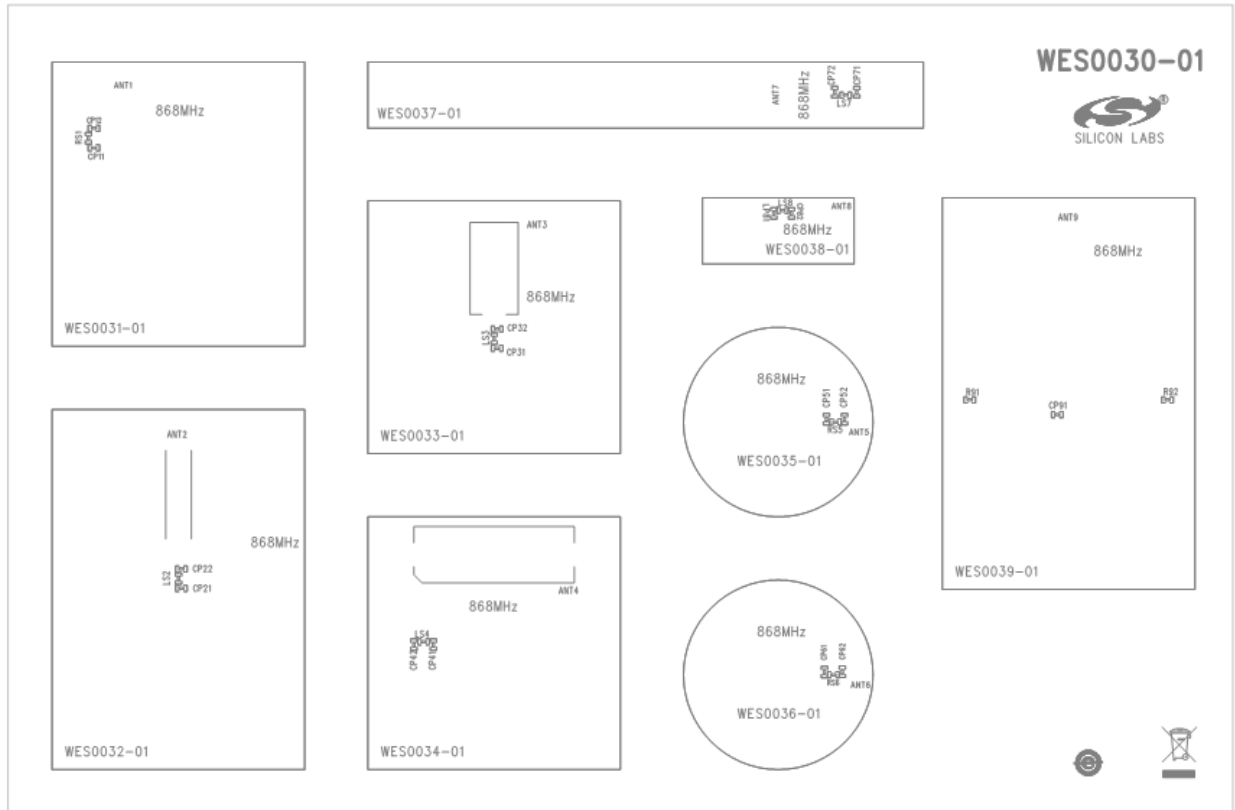

Figure 3. Antenna Positions in the Matrix

3.1. Typical Applications of the Antenna Types,

Each antenna type described in this section has advantages and disadvantages relative to context and intended use.

Medium Size Printed ILA (or optionally IFA) around the PCB circumference (WES0031-01-APL868M-01): This is a low-cost, printed monopole antenna. This type uses a narrow PCB strip around the PCB circumference as the antenna area, thereby saving significant space. The drawback is the reduced gain. This is especially true if the antenna trace is close to the ground metal of the circuitry. This antenna type is sensitive to hand effect, so bench tuning with hand in place is required. But the hand effect can also improve the radiation if the hand covers mostly or only the circuit area.

Due to these properties, this antenna type is frequently used in key fobs, where the range requirement is usually moderate.

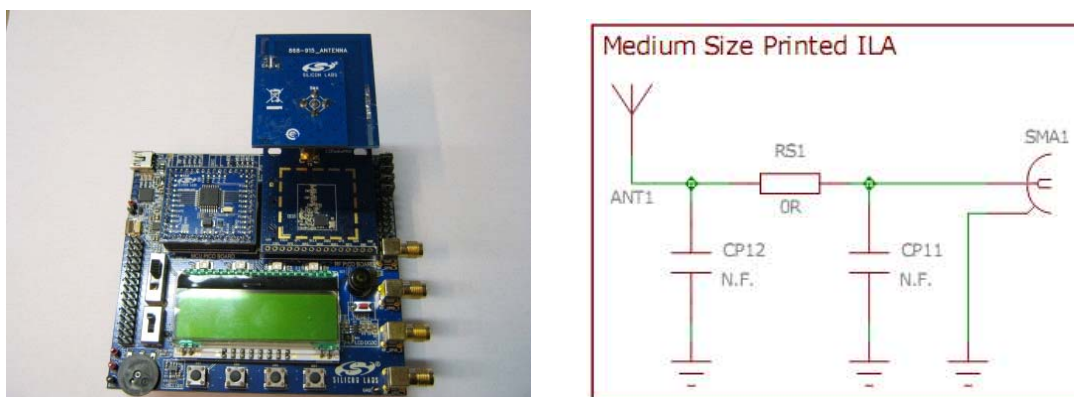

Figure 4. Medium Size Printed ILA

Ceramic (Chip) Antenna (WES0032-01-ACM868D-01): This type of antenna usually requires a relatively large circuit area with the gaps filled in with ground metal. This antenna type is a very good, high-gain, smaller alternative to any printed antenna. However, the cost of the chip antenna is higher. It is typically used in set top boxes and AMRs, where the slight additional cost can be tolerated.

Chip antennas are usually realized on high epsilon dielectric, so the hand effect has less influence on them, unless the PCB circuitry area (with ground metal) is small. The reason is that the increase of a small ground size by the hand changes (usually improves) the radiation. Bench tuning of the impedance with hand is still required.

Chip antennas are not generally used in key fobs due to their relatively higher price.

The antenna used in the Matrix is the ANT-868-CHP-T from the Antenna Factor. With the applied antenna PCB ground size, this antenna requires a two element external matching network at the input.

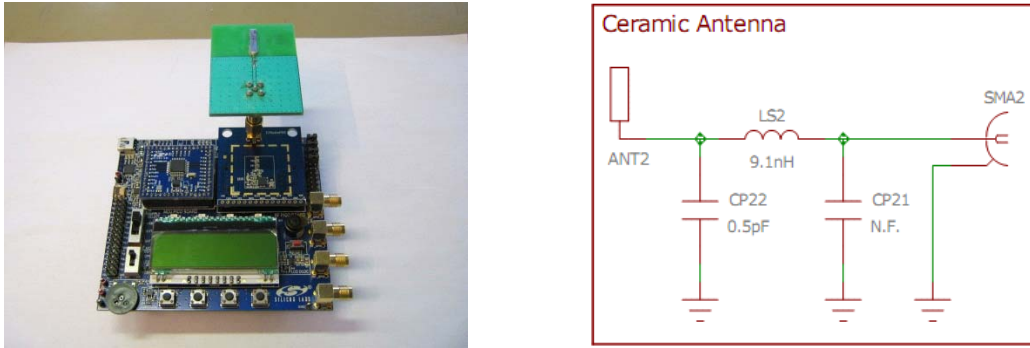

Figure 5. WES0032-01-ACM868D-01

Small Size (Wire) Helical Antenna parallel with the PCB (WES0033-01-AWH868S-01): This antenna is a popular, very small, low-cost alternative to the external whip antenna, but it has a lower gain. At lower frequencies the gain can be improved by using a ferrite in it. This type of antenna is typically used in set top boxes, AMRs, alarm systems, and key fobs.

The small helical antenna used in the Matrix is the ANT-868-JJB-RA from the Antenna Factor. Due to the small size of the antenna PCB (ground), an additional external matching network is required at the antenna input (Figure 6.). The helical monopole is sensitive to hand effect, even if only the circuit (ground) area of the antenna PCB is touched, which in effect causes the ground size around the antenna to change. Because of this hand effect the modification (or elimination) of the above mentioned external matching network is required.

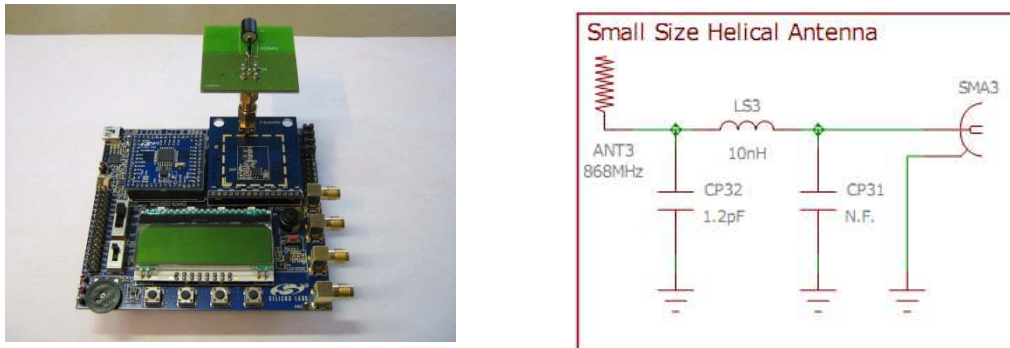

Figure 6. WES0033-01-AWH868S-01

Medium Size (Wire) Helical Antenna (WES0034-01-AWH868M-01): This type of antenna is a popular, small, low-cost, wire alternative to the external whip antenna, but it has a lower gain. At lower frequencies the gain can be improved by using a ferrite in it. Typically this type of antenna is used in key fobs, set top boxes, AMRs, and alarm systems. In this matrix the ANT-916-HETH from the Antenna Factor is selected with an additional external series 8.2 nH matching inductor at the antenna input to tune it down to 868 MHz.

The helical monopole is sensitive to hand effect, which is true even if only the circuit (ground) area of the PCB is touched and the ground size is small. In this case, the ground size around the antenna changes (the radiation usually improves). Because of the hand effect further tuning of the matching network is necessary.

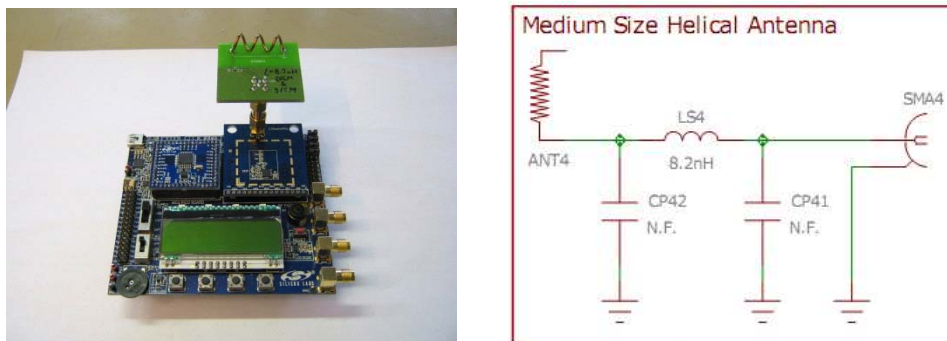

Figure 7. WES0034-01-AWH868M-01

Panic Button ILA (WES0035-01-APF868P-01) and Panic Button IFA (WES0036-01-APL868P-01) along the circumference: These type of antennas are very low-cost, small monopole type antennas. Typically they fully surround the small circuitry along the PCB edge, which allows them to have the highest possible radiation efficiency and make impedance tuning easier.

These antennas are basically the same as the first antenna type (e.g. WES0031-01-APL868M-01). The antenna trace also runs along the PCB circumference, but the PCB is significantly smaller.

Due to the very small size, the gain is low, especially at low frequency bands, and these solutions are also sensitive to the hand effect. Typically, these antennas are used in wristband panic buttons applications, where strong hand effect exists. Here the antenna is parallel with the hand, and, thus, the hand degrades the radiation. Fortunately, the range requirement is also low in most cases.

The main difference between the ILA and IFA is that the ILA needs a parallel matching capacitor (5.6 pF here) at the input, while the IFA is inherently matched. However, the post tuning of the ILA is easier. In the upcoming document “Antenna Design Guide for Single Ended 50 Ω Antennas,” Silicon Labs will provide a detailed description of the tuning process, both for the ILA and IFA antennas. The panic button antennas given in this Matrix are tuned without hand effect, so the range achieved with them is better than what one could see with the hand effect.

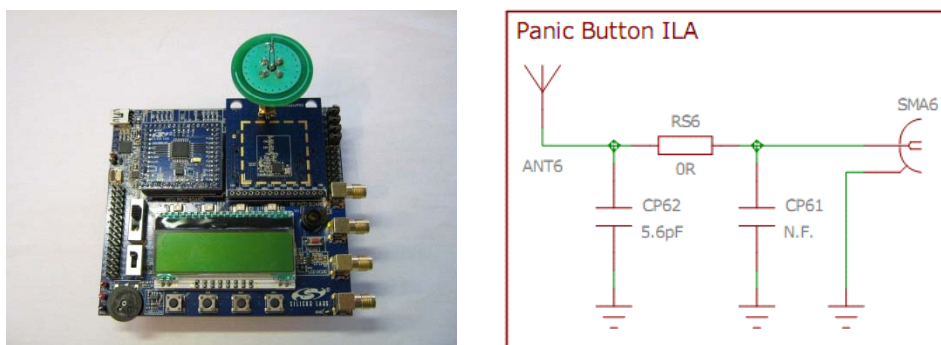

Figure 8. WES0035-01-APF868P-01

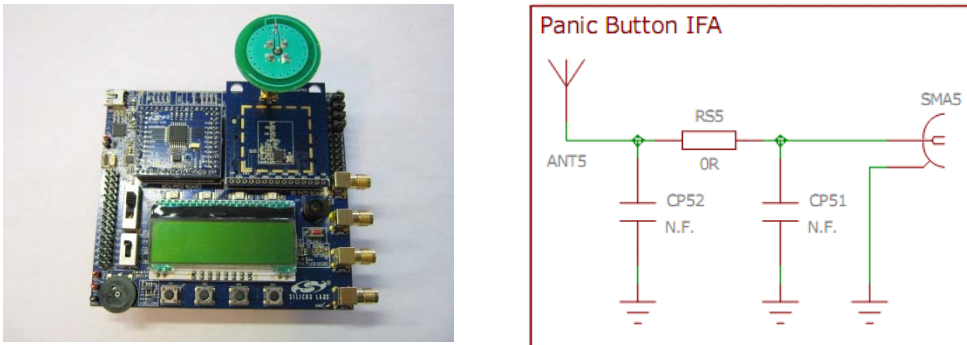

Figure 9. WES0036-01-APL868P-01

Printed Meander Monopole (WES0037-01-APN868D-01): This type is a low cost, reduced size, printed alternative to the external whip antenna, but it requires a separate antenna area, which is larger than the space required by a typical printed ILA or IFA, around the PCB circumference or by a wire helical antenna. On the other hand, it has higher gain as well.

If the meander antenna is put on a separate PCB, then it works best if the antenna PCB is perpendicular to the circuit PCB or to a large ground metal. The gain is significantly better than that of a PCB circumference printed ILA or a wire helical antenna.

The meander antenna is sensitive to hand effect. As usual, the hand can improve radiation if the hand covers the circuit area only.

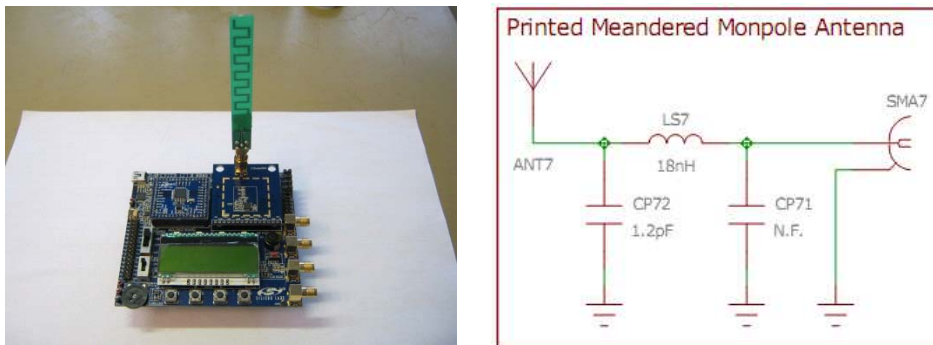

Figure 10. WES0037-01-APN868D-01

Small Size Printed ILA (or optionally IFA) in dedicated small antenna area (WES0038-01-APL868S-01): This type of antenna is typically used in dongles and key fobs, where a limited-size, separate antenna area is available and where there is not enough space along the PCB circumference for a good antenna. The gain is limited, but the presence of a nearby hand or a large amount of metal (exp., computer chassis) can improve gain significantly if only the circuit area of the PCB is covered. The best situation is if the hand or the ground metal is perpendicular to the antenna plane.

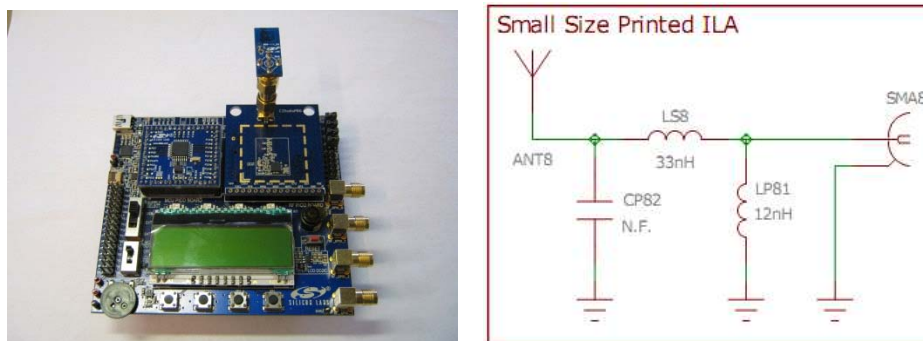

Figure 11. WES0038-01-APL868S-01

Balanced IFA (BIFA) on a larger separate antenna area (WES0039-01-APB868D-01): Due to their bigger size, these antennas have good gain. But the biggest advantage is that the radiation pattern is not influenced too much by the PCB ground size and shape, due to the balanced operation of the antenna (the BIFA antenna is differential and a printed balun is used at the input to connect it to the $50\ \Omega$ single-ended Pico Board input/output). Due to this, the performance of the BIFA antenna is nearly the same without the Pico Board or Motherboard.

Another advantage is that the BIFA antenna mostly radiates to the direction of the antenna's symmetrical axis (more precisely: it radiates mainly along a plane which includes the symmetrical axis and perpendicular to the antenna PCB).

Unfortunately, the BIFA is sensitive to hand effect, if the antenna traces are directly touched. But, it is not sensitive, if only the ground (circuit) part of the PCB is touched.

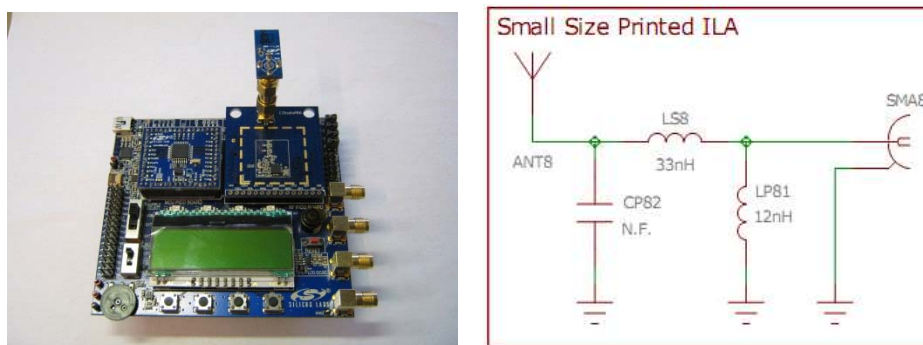

Figure 12. WES0039-01-APB868D-01

4. Documentation

Each antenna type has its own separate description and documentation which contains the following:

- Antenna match schematic (if it exists)
- Top and bottom layout
- Picture
- Measured Impedance
- Measured antenna gain
- Measured radiation pattern
- Harmonic radiation (up to 10th harm)
- Range measurements

The documentation for each antenna includes a manufacturing pack as well downloadables from the web page.

5. Range Measurements

Several open-site range tests were made with every antenna type at 50 kbps and 100 kbps with different orientations and polarizations. In these tests, the same matrix antenna board is used both at the TX and RX site. Also, the results were compared with the range test results between two units using the reference monopole (ANT-868-CW-HWR-SMA). More details can be found in the "range test" subchapters of application note AN782.



In one of the range test measurements, as documented in AN782, the RX and TX antenna face each other in their maximum radiation orientation. Here the antenna PCB or axis is vertically polarized and the applied link settings are 50 kbps, 99 kHz RBW, 14 dBm TX power, and 1% PER. The test site is a flat track of land with lawn. Table 1 summarizes these possible best outdoor range results together with the GPS coordinates.

During the measurements, the range number (in meters) is extracted from the Google map distance plot.

Table 1. Results

| | | | | | GPS | | Distance [m] | | | |
|---------------------|---|-------|--------|------------|--------------------------|------------|--------------|-----|----------|---------|
| | | | | | N | E | | | | |
| | | | | | Base II | 47.126000° | 19.209133° | 0.0 | Base II | |
| | | | | | Base III | 47.158820° | 19.174040° | 0.0 | Base III | |
| Med. ILA (WES0031) | | | | | Max. direction: XZV 0° | | | | 1083.9 | Base II |
| | | | | | | GPS | | | | |
| | 1 | 14dBm | 50kbps | 47.134467° | 19.202033° | | | | | |
| Chip (WES0032) | | | | | Max. direction: XZV 180° | | | | 998.2 | Base II |
| | | | | | | GPS | | | | |
| | 2 | 14dBm | 50kbps | 47.133800° | 19.202600° | | | | | |
| SmI.Helic (WES0033) | | | | | Max. direction: XZV 270° | | | | 1188.3 | Base II |
| | | | | | | GPS | | | | |
| | 3 | 14dBm | 50kbps | 47.135283° | 19.201350° | | | | | |
| Med.Helic (WES0034) | | | | | Max. direction: XZV 90° | | | | 1177.4 | Base II |
| | | | | | | GPS | | | | |
| | 4 | 14dBm | 50kbps | 47.135183° | 19.201383° | | | | | |
| PIFA (WES0035) | | | | | Max. direction: XZV 0° | | | | 1189.0 | Base II |
| | | | | | | GPS | | | | |
| | 5 | 14dBm | 50kbps | 47.135283° | 19.201333° | | | | | |
| PILA (WES0036) | | | | | Max. direction: XZV 0° | | | | 1289.9 | Base II |
| | | | | | | GPS | | | | |
| | 6 | 14dBm | 50kbps | 47.136050° | 19.200617° | | | | | |

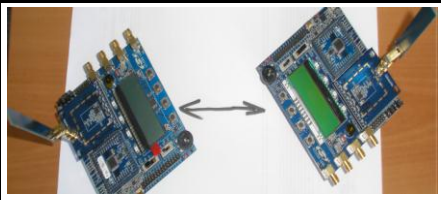
Table 1. Results (continued)

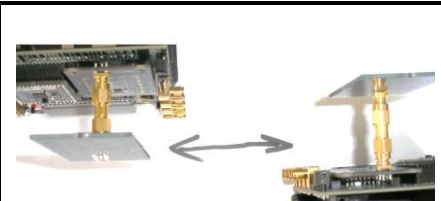
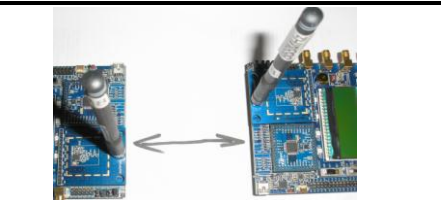
| | | | | | | | | |
|--------------------|--|--|--------------------------|-------|--------|------------|----------|---------|
| Meand (WES0037) |  | | Max. direction: XYV 135° | | | | 1310.4 | Base II |
| | | | GPS | | | | | |
| | | | | | N | E | | |
| | | | 7 | 14dBm | 50kbps | 47.136217° | | |
| Sm.I. ILA(WES0038) |  | | Max. direction: XZV 0° | | | | 548.6 | Base II |
| | | | GPS | | | | | |
| | | | | | N | E | | |
| | | | 8 | 14dBm | 50kbps | 47.130283° | | |
| BIFA (WES0039) |  | | Max. direction: XZV 90° | | | | 973.4 | Base II |
| | | | GPS | | | | | |
| | | | | | N | E | | |
| | | | 9 | 14dBm | 50kbps | 47.133633° | | |
| Rference Monopl |  | | V pol; Norm. direction | | | | 1158.3 | Base II |
| | | | GPS | | | | | |
| | | | | | N | E | | |
| | | | 10 | 14dBm | 50kbps | 47.135050° | | |
| | | | | | | 2151.0 | Base III | |
| | | | | | | | | |

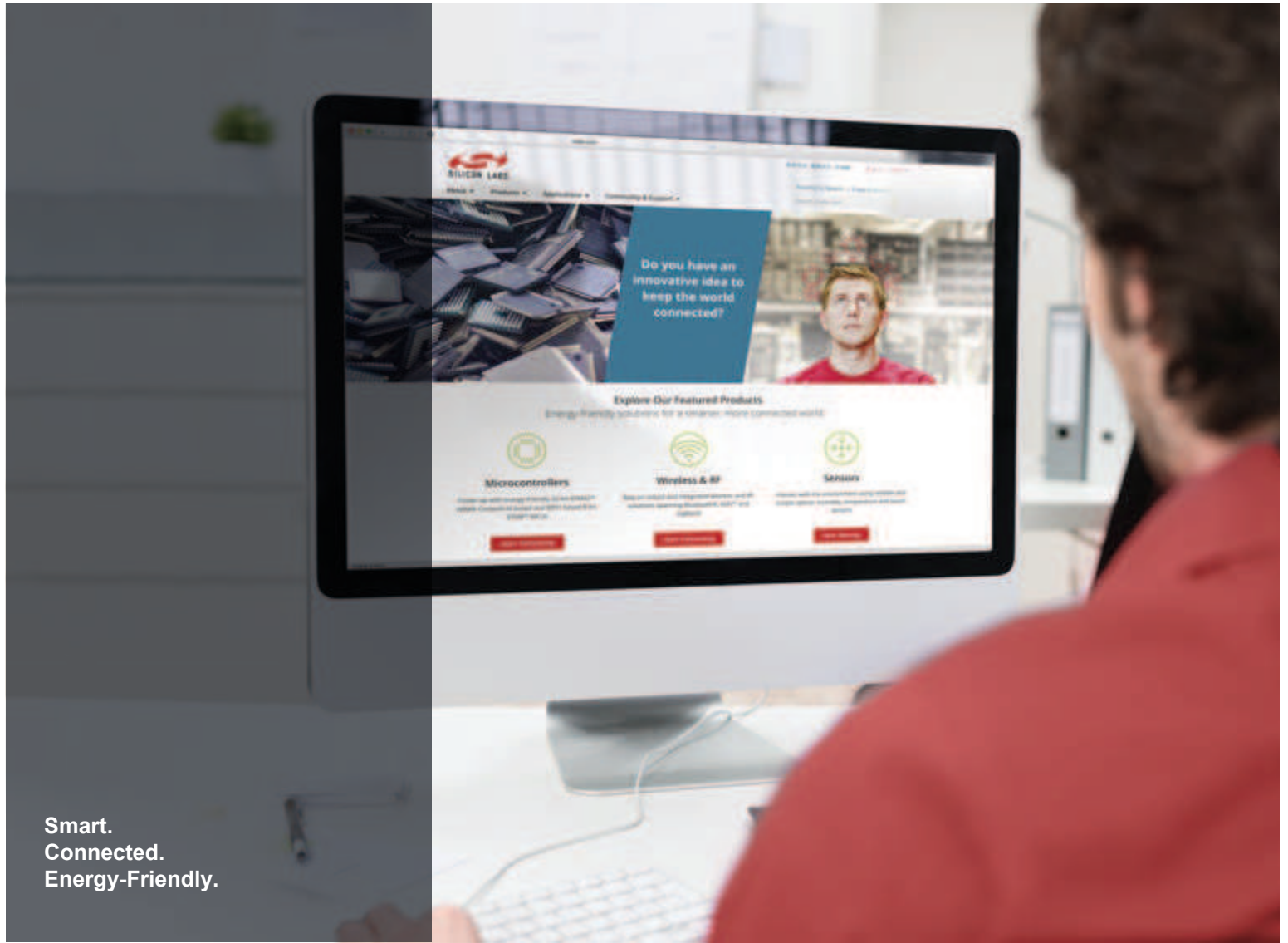

Smart.
Connected.
Energy-Friendly.



Products
www.silabs.com/products

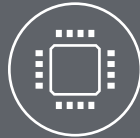

Quality
www.silabs.com/quality



Support and Community
community.silabs.com

Disclaimer

Silicon Labs intends to provide customers with the latest, accurate, and in-depth documentation of all peripherals and modules available for system and software implementers using or intending to use the Silicon Labs products. Characterization data, available modules and peripherals, memory sizes and memory addresses refer to each specific device, and "Typical" parameters provided can and do vary in different applications. Application examples described herein are for illustrative purposes only. Silicon Labs reserves the right to make changes without further notice and limitation to product information, specifications, and descriptions herein, and does not give warranties as to the accuracy or completeness of the included information. Silicon Labs shall have no liability for the consequences of use of the information supplied herein. This document does not imply or express copyright licenses granted hereunder to design or fabricate any integrated circuits. The products are not designed or authorized to be used within any Life Support System without the specific written consent of Silicon Labs. A "Life Support System" is any product or system intended to support or sustain life and/or health, which, if it fails, can be reasonably expected to result in significant personal injury or death. Silicon Labs products are not designed or authorized for military applications. Silicon Labs products shall under no circumstances be used in weapons of mass destruction including (but not limited to) nuclear, biological or chemical weapons, or missiles capable of delivering such weapons.

Trademark Information

Silicon Laboratories Inc.®, Silicon Laboratories®, Silicon Labs®, SiLabs® and the Silicon Labs logo®, Bluegiga®, Bluegiga Logo®, Clockbuilder®, CMEMS®, DSPLL®, EFM®, EFM32®, EFR, Ember®, Energy Micro, Energy Micro logo and combinations thereof, "the world's most energy friendly microcontrollers", Ember®, EZLink®, EZRadio®, EZRadioPRO®, Gecko®, ISOModem®, Precision32®, ProSLIC®, Simplicity Studio®, SiPHY®, Telegesis, the Telegesis Logo®, USBXpress® and others are trademarks or registered trademarks of Silicon Labs. ARM, CORTEX, Cortex-M3 and THUMB are trademarks or registered trademarks of ARM Holdings. Keil is a registered trademark of ARM Limited. All other products or brand names mentioned herein are trademarks of their respective holders.



SILICON LABS

Silicon Laboratories Inc.
400 West Cesar Chavez
Austin, TX 78701
USA

<http://www.silabs.com>