



Chipsmall Limited consists of a professional team with an average of over 10 year of expertise in the distribution of electronic components. Based in Hongkong, we have already established firm and mutual-benefit business relationships with customers from,Europe,America and south Asia,supplying obsolete and hard-to-find components to meet their specific needs.

With the principle of “Quality Parts,Customers Priority,Honest Operation,and Considerate Service”,our business mainly focus on the distribution of electronic components. Line cards we deal with include Microchip,ALPS,ROHM,Xilinx,Pulse,ON,Everlight and Freescale. Main products comprise IC,Modules,Potentiometer,IC Socket,Relay,Connector.Our parts cover such applications as commercial,industrial, and automotives areas.

We are looking forward to setting up business relationship with you and hope to provide you with the best service and solution. Let us make a better world for our industry!



## Contact us

Tel: +86-755-8981 8866 Fax: +86-755-8427 6832

Email & Skype: info@chipsmall.com Web: www.chipsmall.com

Address: A1208, Overseas Decoration Building, #122 Zhenhua RD., Futian, Shenzhen, China





## Glass Passivated Rectifier Diode Modules

**VRRM** 800 to 1800V  
**IFAV** 120 Amp

### Applications

- Non-controllable rectifiers for AC/AC converters
- Line rectifiers for transistorized AC motor controllers
- Field supply for DC motors

### Features

- Blocking voltage: 800 to 1800V
- Heat transfer through aluminum oxide ceramic isolated metal baseplate
- Glass passivated chip

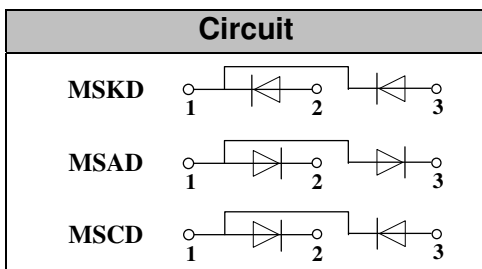

### Module Type

TYPE			VRRM	VRSM
MSKD120-08	MSAD120-08	MSCD120-08	800V	900V
MSKD120-12	MSAD120-12	MSCD120-12	1200V	1300V
MSKD120-16	MSAD120-16	MSCD120-16	1600V	1700V
MSKD120-18	MSAD120-18	MSCD120-18	1800V	1900V

### Maximum Ratings

Symbol	Conditions	Values	Units
IFAV	Tc=100°C	120	A
IFSM	t=10mS Tvj =45°C	2800	A
i <sup>2</sup> t	t=10mS Tvj =45°C	39200	A <sup>2</sup> s
Visol	a.c.50Hz;r.m.s.;1min	3000	V
Tvj		-40 to 150	°C
Tstg		-40 to 125	°C
Mt	To terminals(M5)	2 . 5-4	Nm
Ms	To heatsink(M5)	2 . 5-4	Nm
Weight	Module	110	g

### Thermal Characteristics

Symbol	Conditions	Values	Units
Rth(j-c)	Per diode	0.26	°C/W
Rth(c-s)	Module	0.1	°C/W

### Electrical Characteristics

Symbol	Conditions	Values	Units
VFM	T=25°C IFM =300A	1.43	V
IRD	Tvj=TvjM VRD=VRRM	≤6	mA

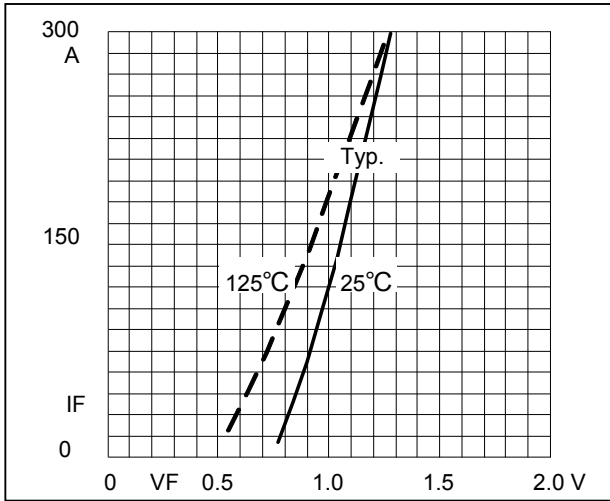
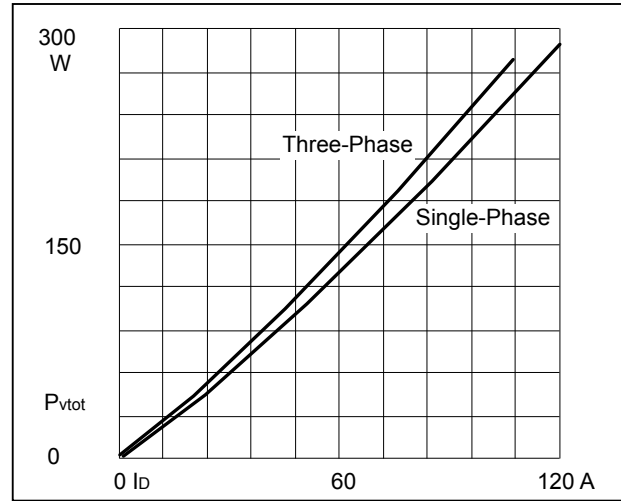
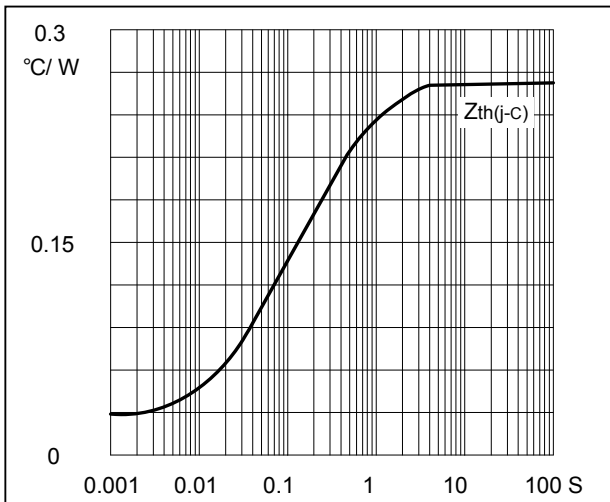
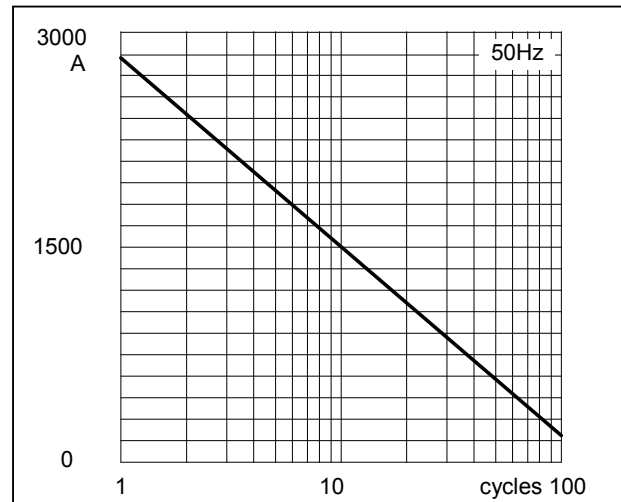
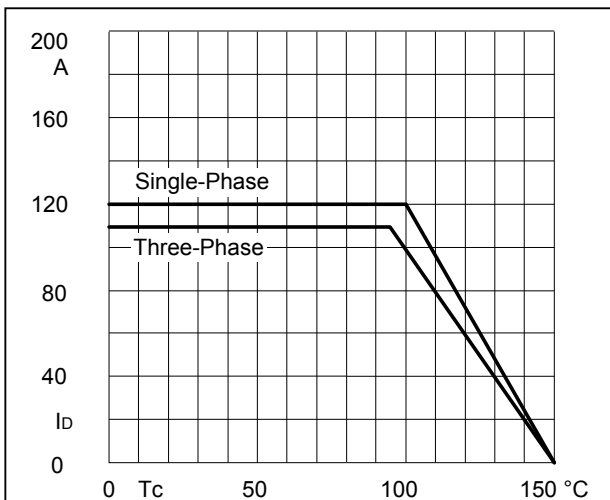
**Performance Curves**

**Fig1. Forward Characteristics**

**Fig2. Power dissipation**

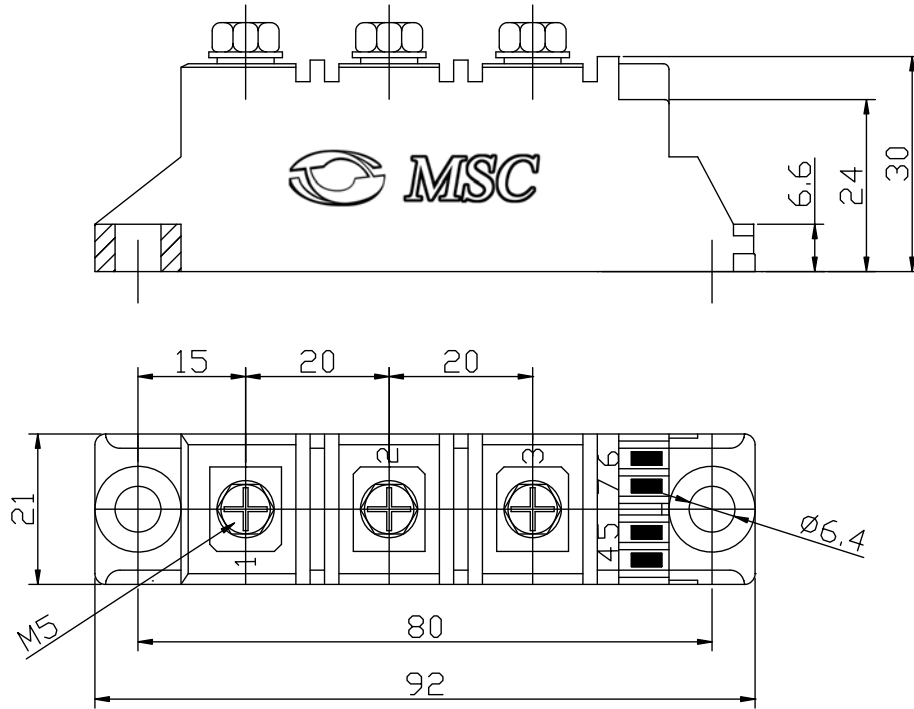
**Fig3. Transient thermal impedance**

**Fig4. Max Non-Repetitive Forward Surge Current**

**Fig5. Forward Current Derating Curve**

**Package Outline Information**

**CASE-D1**



**Dimensions in mm**