



Chipsmall Limited consists of a professional team with an average of over 10 year of expertise in the distribution of electronic components. Based in Hongkong, we have already established firm and mutual-benefit business relationships with customers from,Europe,America and south Asia,supplying obsolete and hard-to-find components to meet their specific needs.

With the principle of “Quality Parts,Customers Priority,Honest Operation,and Considerate Service”,our business mainly focus on the distribution of electronic components. Line cards we deal with include Microchip,ALPS,ROHM,Xilinx,Pulse,ON,Everlight and Freescale. Main products comprise IC,Modules,Potentiometer,IC Socket,Relay,Connector.Our parts cover such applications as commercial,industrial, and automotives areas.

We are looking forward to setting up business relationship with you and hope to provide you with the best service and solution. Let us make a better world for our industry!



Contact us

Tel: +86-755-8981 8866 Fax: +86-755-8427 6832

Email & Skype: info@chipsmall.com Web: www.chipsmall.com

Address: A1208, Overseas Decoration Building, #122 Zhenhua RD., Futian, Shenzhen, China





■ Features :

- Universal AC input / Full range
- Built-in active PFC function, PF>0.95
- High efficiency up to 89.5%
- Withstand 300VAC surge input for 5 seconds
- Protections: Short circuit / Overload / Over voltage / Over temperature
- Built-in constant current limiting circuit
- Medical safety approved (MOOP level)
- Built-in cooling Fan ON-OFF control
- Built-in DC OK signal
- Built-in remote ON-OFF control
- Stand by 5V@0.3A
- Built-in remote sense function
- No load power consumption<0.6W (Note.6)
- 5 years warranty



SPECIFICATION

MODEL	MSP-450-3.3	MSP-450-5	MSP-450-7.5	MSP-450-12	MSP-450-15	MSP-450-24	MSP-450-36	MSP-450-48	
OUTPUT	DC VOLTAGE	3.3V	5V	7.5V	12V	15V	24V	36V	48V
	RATED CURRENT	90A	90A	60A	37.5A	30A	18.8A	12.5A	9.5A
	CURRENT RANGE	0 ~ 90A	0 ~ 90A	0 ~ 60A	0 ~ 37.5A	0 ~ 30A	0 ~ 18.8A	0 ~ 12.5A	0 ~ 9.5A
	RATED POWER	297W	450W	450W	450W	450W	451.2W	450W	456W
	RIPPLE & NOISE (max.) Note.2	80mVp-p	80mVp-p	100mVp-p	120mVp-p	150mVp-p	150mVp-p	240mVp-p	240mVp-p
	VOLTAGE ADJ. RANGE	2.8 ~ 3.8V	4.3 ~ 5.8V	6.8 ~ 9V	10.2 ~ 13.8V	13.5 ~ 18V	21.6 ~ 28.8V	28.8 ~ 39.6V	40.8 ~ 55.2V
	VOLTAGE TOLERANCE Note.3	±2.0%	±2.0%	±2.0%	±1.0%	±1.0%	±1.0%	±1.0%	±1.0%
	LINE REGULATION	±0.5%	±0.5%	±0.5%	±0.3%	±0.3%	±0.2%	±0.2%	±0.2%
	LOAD REGULATION	±1.0%	±1.0%	±1.0%	±0.5%	±0.5%	±0.5%	±0.5%	±0.5%
	SETUP, RISE TIME	1000ms, 100ms/230VAC 2500ms, 100ms/115VAC at full load							
HOLD UP TIME (Typ.)	16ms/230VAC 16ms/115VAC at full load								
INPUT	VOLTAGE RANGE Note.4	85 ~ 264VAC 120 ~ 370VDC							
	FREQUENCY RANGE	47 ~ 63Hz							
	POWER FACTOR (Typ.)	PF>0.95/230VAC PF>0.99/115VAC at full load							
	EFFICIENCY (Typ.)	80%	83%	86.5%	88%	89%	88%	89%	89.5%
	AC CURRENT (Typ.)	5A/115VAC 2.4A/230VAC							
	INRUSH CURRENT (Typ.)	35A/115VAC 70A/230VAC							
	LEAKAGE CURRENT	Earth leakage current < 300 μ A/264VAC , Touch leakage current < 100 μ A/264VAC							
PROTECTION	OVERLOAD	105 ~ 135% rated output power Protection type : Constant current limiting, recovers automatically after fault condition is removed							
	OVER VOLTAGE	3.96 ~ 4.62V	6 ~ 7V	9.4 ~ 10.9V	14.4 ~ 16.8V	18.8 ~ 21.8V	30 ~ 34.8V	41.4 ~ 48.6V	57.6 ~ 67.2V
	OVER TEMPERATURE	Shut down o/p voltage, recovers automatically after temperature goes down							
FUNCTION	5V STANDBY	5VSB : 5V@0.3A ; tolerance ±5% , ripple : 50mVp-p(max.)							
	DC OK SIGNAL	PSU turn on : 3.3 ~ 5.6V ; PSU turn off : 0 ~ 1V							
	REMOTE CONTROL	RC+ / RC- : 4 ~ 10V or open = power on ; 0 ~ 0.8V or short = power off							
	FAN CONTROL (Typ.)	Load 20 ± 10% or RTH2 ≥ 50°C Fan on							
ENVIRONMENT	WORKING TEMP.	-40 ~ +70°C (Refer to "Derating Curve")							
	WORKING HUMIDITY	20 ~ 90% RH non-condensing							
	STORAGE TEMP., HUMIDITY	-40 ~ +85°C, 10 ~ 95% RH non-condensing							
	TEMP. COEFFICIENT	±0.03%/°C (0 ~ 50°C)							
	VIBRATION	10 ~ 500Hz, 5G 10min./1cycle, 60min. each along X, Y, Z axes							
SAFETY & EMC (Note 8)	SAFETY STANDARDS	ANSI/AAMI ES60601-1, IEC60601-1, EAC TP TC 004 approved							
	ISOLATION LEVEL	Primary-Secondary: 2×MOOP, Primary-Earth: 1×MOOP, Secondary-Earth: 1×MOOP							
	WITHSTAND VOLTAGE	I/P-O/P:4KVAC I/P-FG:2KVAC O/P-FG:0.5KVAC							
	ISOLATION RESISTANCE	I/P-O/P, I/P-FG, O/P-FG:100M Ohms / 500VDC / 25°C / 70% RH							
	EMC EMISSION	Compliance to EN55011 (CISPR11) Class B, EN61000-3-2,-3, EAC TP TC 020							
	EMC IMMUNITY	Compliance to EN61000-4-2,3,4,5,6,8,11, EN60601-1-2, EAC TP TC 020							
OTHERS	MTBF	159.3K hrs min. MIL-HDBK-217F (25°C)							
	DIMENSION	218*105*41mm (L*W*H)							
	PACKING	1.19Kg; 12pcs/15.3Kg/0.82CUFT							
NOTE	<p>1. All parameters NOT specially mentioned are measured at 230VAC input, rated load and 25°C of ambient temperature.</p> <p>2. Ripple & noise are measured at 20MHz of bandwidth by using a 12" twisted pair-wire terminated with a 0.1uF & 47uF parallel capacitor.</p> <p>3. Tolerance : includes set up tolerance, line regulation and load regulation.</p> <p>4. Derating may be needed under low input voltages. Please check the derating curve for more details.</p> <p>5. Length of set up time is measured at first cold start. Turning ON/OFF the power supply may lead to increase of the set up time.</p> <p>6. No load power consumption<0.5W when RC- & RC+ (CN100 pin1,2) 0 ~ 0.8V or short.</p> <p>7. When the input voltage is less than 40VAC, the SPS may exhibit degradation of performance. The final product manufacturers must re-confirm this deviation that does not affect basic safety or essential performance.</p> <p>8. The power supply is considered a component which will be installed into a final equipment. All the EMC tests are been executed by mounting the unit on a 360mm*360mm metal plate with 1mm of thickness. The final equipment must be re-confirmed that it still meets EMC directives. For guidance on how to perform these EMC tests, please refer to "EMI testing of component power supplies." (as available on http://www.meanwell.com)</p> <p>9. The ambient temperature derating of 3.5°C/1000m with fanless models and of 5°C/1000m with fan models for operating altitude higher than 2000m(6500ft).</p>								

Mechanical Specification

Case No. 995A Unit:mm

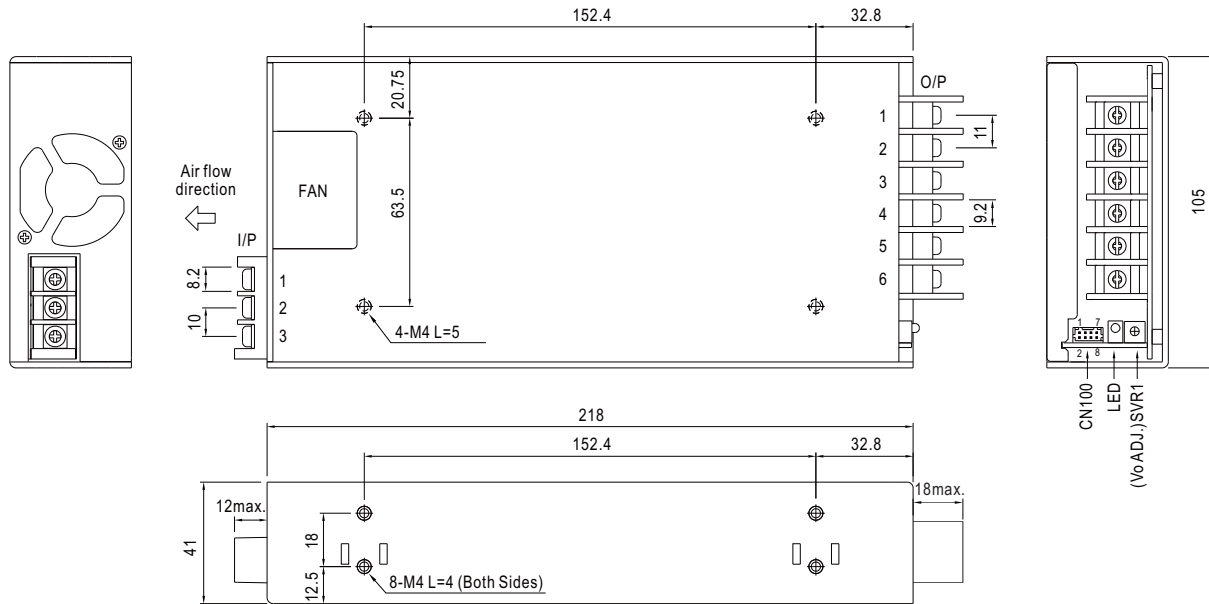

AC Input Terminal Pin No. Assignment

Pin No.	Assignment
1	AC/L
2	AC/N
3	FG \perp

DC Output Terminal Pin No. Assignment

Pin No.	Assignment
1~3	-V
4~6	+V

Connector Pin No. Assignment (CN100) : HRS DF11-8DP-2DS or equivalent

Pin No.	Assignment	Pin No.	Assignment	Mating Housing	Terminal
1	RC+	5	DC-OK	HRS DF11-8DS or equivalent	HRS DF11-**SC or equivalent
2	RC-	6	GND		
3	AUX	7	+S		
4	AUXG	8	-S		

Block Diagram

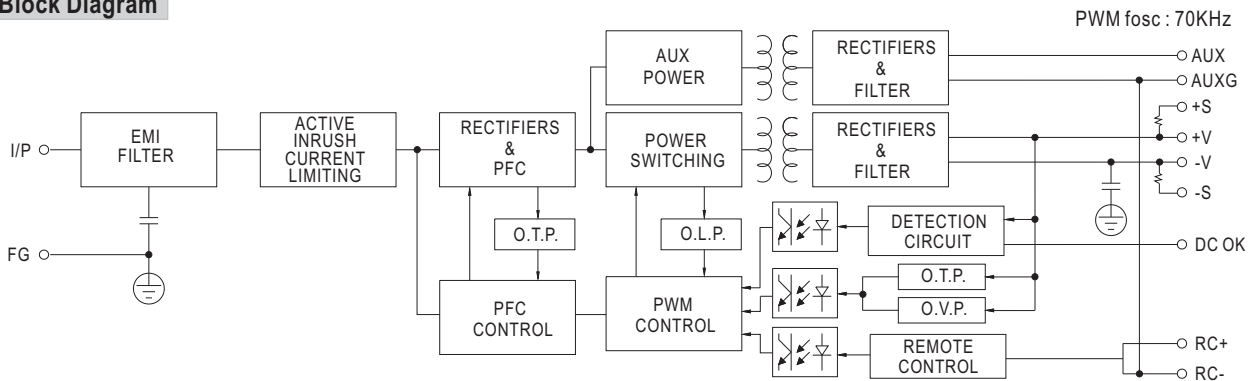

Derating Curve

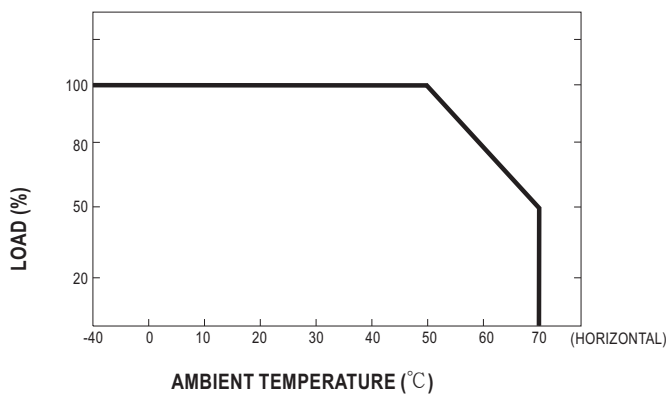

Output Derating VS Input Voltage

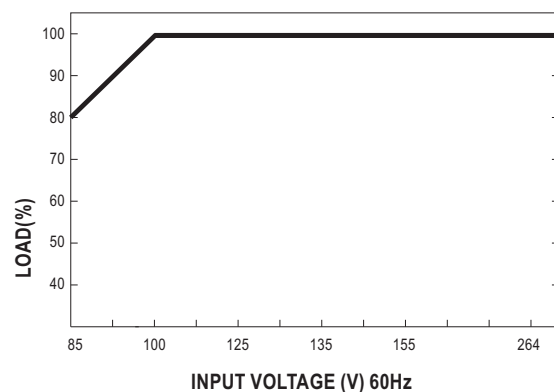

Function Description of CN100

Pin No.	Function	Description
1	RC+	Turns the output on and off by electrical or dry contact between pin 2 (RC-), Short: Power OFF, Open: Power ON.
2	RC-	Remote control ground.
3	AUX	Auxiliary voltage output, 4.75~5.25V, referenced to pin 4(AUXG). The maximum load current is 0.3A. This output is not controlled by the "remote ON/OFF control".
4	AUXG	Auxiliary voltage output ground. The signal return is isolated from the output terminals (+V & -V).
5	DC-OK	DC-OK Signal is a TTL level signal, referenced to pin6(DC-OK GND). High when PSU turns on.
6	GND	This pin connects to the negative terminal(-V). Return for DC-OK signal output.
7	+S	Positive sensing. The +S signal should be connected to the positive terminal of the load. The +S and -S leads should be twisted in pair to minimize noise pick-up effect. The maximum line drop compensation is 0.5V.
8	-S	Negative sensing. The -S signal should be connected to the negative terminal of the load. The -S and +S leads should be twisted in pair to minimize noise pick-up effect. The maximum line drop compensation is 0.5V.

Function Manual

1. Remote Sense

The remote sensing compensates voltage drop on the load wiring up to 0.5V.

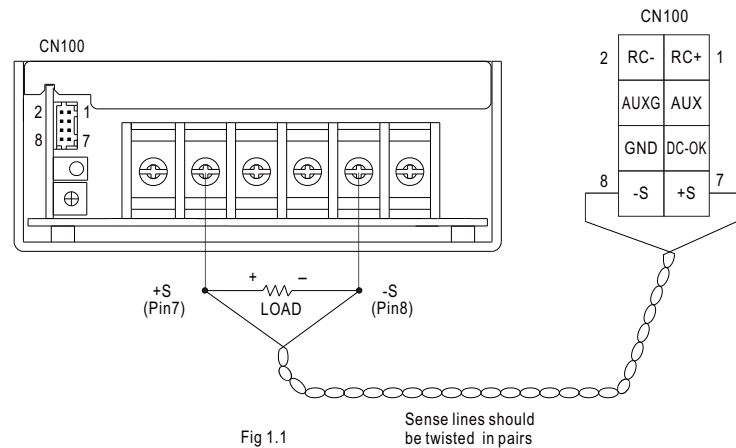

Fig 1.1

2. DC-OK Signal

DC-OK signal is a TTL level signal. High when PSU turns on.

Between DC-OK(pin5) and GND(pin6)	Output Status
3.3 ~ 5.6V	ON
0 ~ 1V	OFF

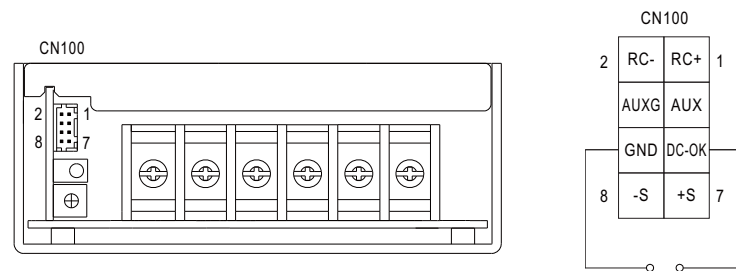

Fig 2.1

3. Remote Control

The PSU can be turned ON/OFF by using the "Remote Control" function.

Between RC+(pin1) and RC-(pin2)	Output Status
SW ON (Short)	OFF
SW OFF (Open)	ON

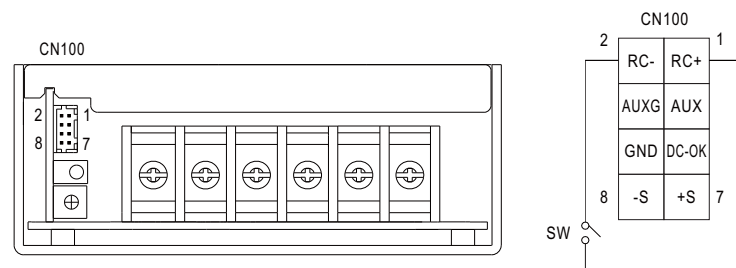

Fig 3.1