



Chipsmall Limited consists of a professional team with an average of over 10 year of expertise in the distribution of electronic components. Based in Hongkong, we have already established firm and mutual-benefit business relationships with customers from,Europe,America and south Asia,supplying obsolete and hard-to-find components to meet their specific needs.

With the principle of “Quality Parts,Customers Priority,Honest Operation,and Considerate Service”,our business mainly focus on the distribution of electronic components. Line cards we deal with include Microchip,ALPS,ROHM,Xilinx,Pulse,ON,Everlight and Freescale. Main products comprise IC,Modules,Potentiometer,IC Socket,Relay,Connector.Our parts cover such applications as commercial,industrial, and automotives areas.

We are looking forward to setting up business relationship with you and hope to provide you with the best service and solution. Let us make a better world for our industry!



Contact us

Tel: +86-755-8981 8866 Fax: +86-755-8427 6832

Email & Skype: info@chipsmall.com Web: www.chipsmall.com

Address: A1208, Overseas Decoration Building, #122 Zhenhua RD., Futian, Shenzhen, China





3Northway Lane North Latham,New York 12110.

Tollfree:1.800.984.5337

Phone:1.518.956.2980

Fax:1.518.785.4725

Http://www.marktechopto.com

SPECIFICATION

PART NO. : MT3030-WT-A

3.0mm ROUND LED LAMP



ATTENTION

**OBSERVE PRECAUTION
FOR HANDLING
ELECTROSTATIC
SENSITIVE
DEVICES**

Description

This white lamp is made with InGaN/Sapphire chip and water clear epoxy resin.

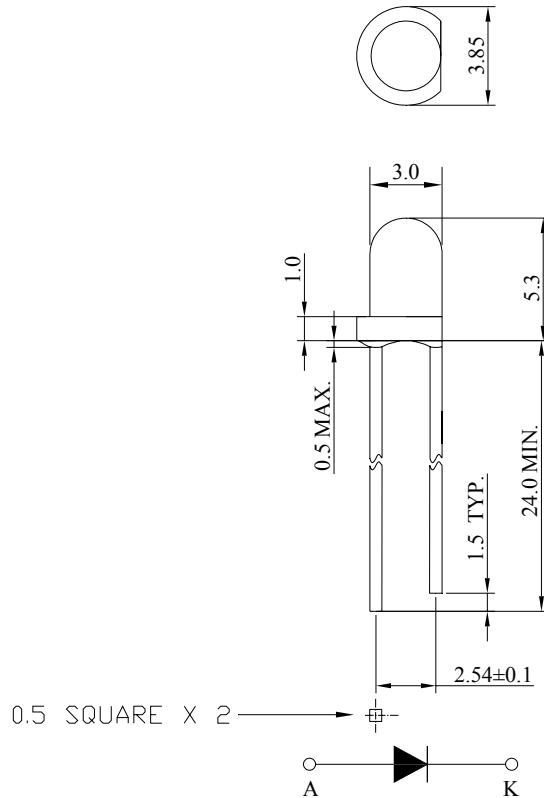

Notes:

1. All dimensions are in mm.
2. Tolerance is ± 0.25 mm unless otherwise noted.

Description

Part No.	LED Chip		Lens Color
	Material	Emitting Color	
MT3030-WT-A	InGaN/Sapphire	White	Water clear

Absolute Maximum Ratings at Ta=25°C

Parameter	Symbol	Rating	Unit
Power Dissipation	P _D	114	mW
Reverse Voltage	V _R	5	V
D.C. Forward Current	I _f	30	mA
Reverse (Leakage) Current	I _r	50	μ A
Peak Current(1/10Duty Cycle,0.1ms Pulse Width.)	I _f (Peak)	100	mA
Operating Temperature Range	T _{opr}	-25 to +85	°C
Storage Temperature Range	T _{stg}	-40 to +100	°C
Soldering Temperature(1.6mm from body)	T _{sol}	Dip Soldering : 260°C for 5 sec. Hand Soldering : 350°C for 3 sec.	
Electrostatic discharge	ESD	6000	V

Electrical and Optical Characteristics:

Parameter	Symbol	Condition	Min.	Typ.	Max.	Unit
Luminous Intensity	I _v	I _f =20mA	4180	8500		mcd
Forward Voltage	V _f	I _f =20mA		3.2	3.8	V
CIE Chromaticity Coordinates:X Axis	X	I _f =20mA		0.30		
CIE Chromaticity Coordinates:Y Axis	Y	I _f =20mA		0.30		
Reverse (Leakage) Current	I _r	V _r =5V			50	μA
Viewing Angle	2θ 1/2	I _f =20mA		30		deg

Notes:1. The datas tested by IS tester.

2. Customer's special requirements are also welcome.

Chromaticity Coordinates Specifications for Bin Grading:

COLOR RANKS(IF=20Ma.Ta=25°C)

BiN	RANK BiN RANK										
We	X	0.27	0.28	0.291	0.281	Wj	X	0.296	0.304	0.315	0.307
	Y	0.265	0.282	0.273	0.256		Y	0.307	0.319	0.311	0.298
Wf	X	0.281	0.291	0.302	0.292	Wk	X	0.307	0.315	0.326	0.318
	Y	0.256	0.273	0.265	0.248		Y	0.298	0.311	0.303	0.29
Wg	X	0.28	0.288	0.299	0.291	Wm	X	0.304	0.312	0.323	0.315
	Y	0.282	0.294	0.286	0.273		Y	0.319	0.331	0.323	0.311
Wh	X	0.291	0.299	0.31	0.302	Wn	X	0.315	0.323	0.334	0.326
	Y	0.273	0.286	0.277	0.265		Y	0.311	0.323	0.315	0.303
W2						W3					

Notes:X.Y Tolerance each Bin limit is± 0.01.

Chromaticity Coordinates & Bin grading diagram:

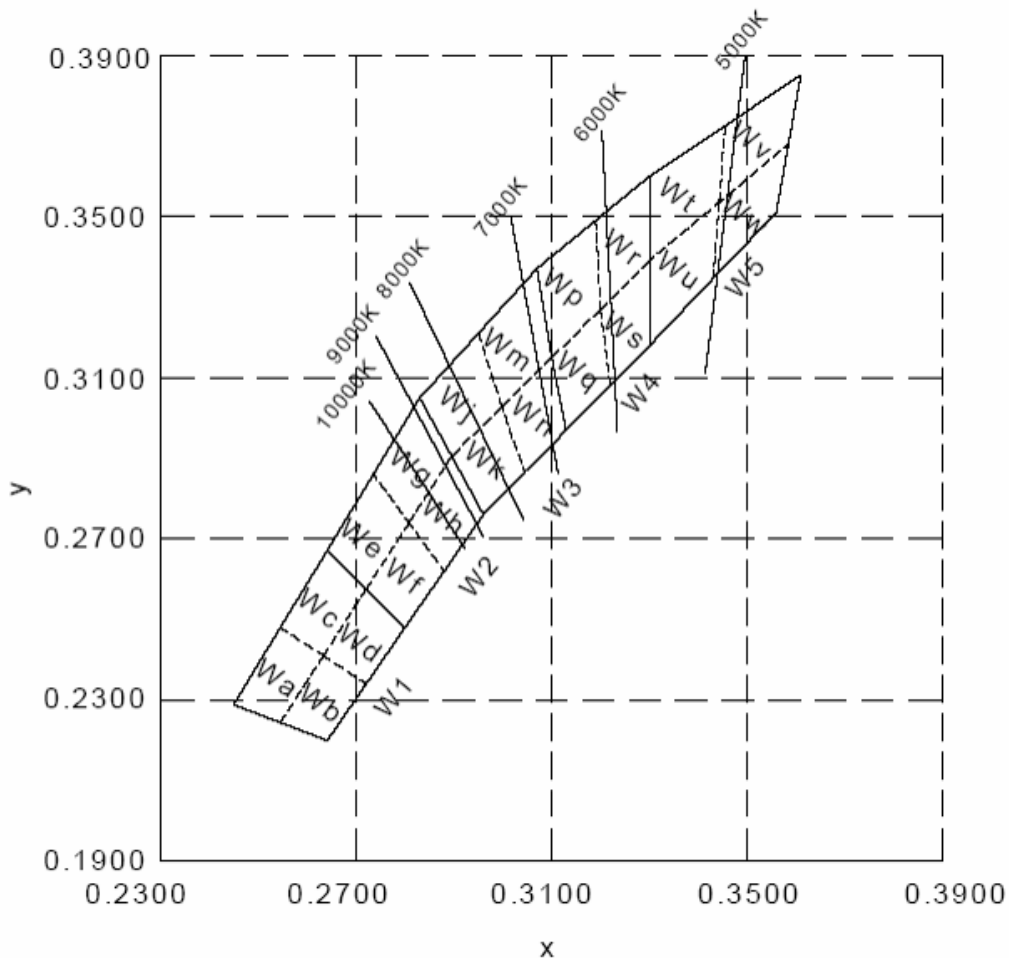

Specifications for Bin Grading:

Iv(mcd)		
Bin	Min	Max
X0	4180	5860
Y0	5860	8200
Z0	8200	12000

Specifications for Vf Group:

Vf(V)		
Bin	Min	Max
28	3.0	3.2
29	3.2	3.4
2a	3.4	3.6
2b	3.6	3.8

Typical Electrical / Optical Characteristics Curves :

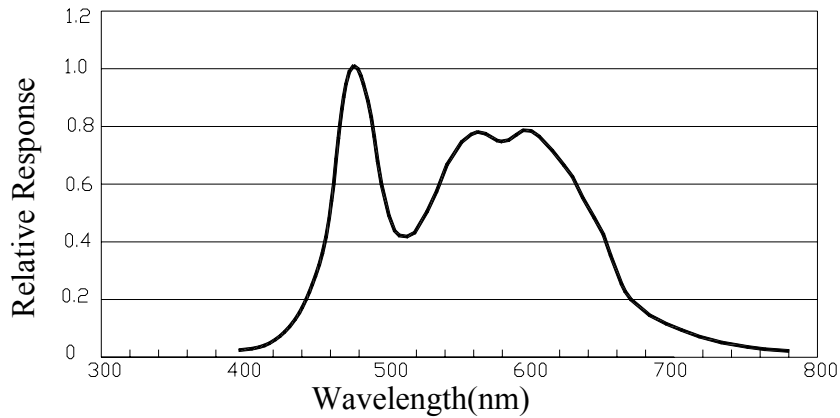

WHITE LED SPECTRUM VS. WAVELENGTH

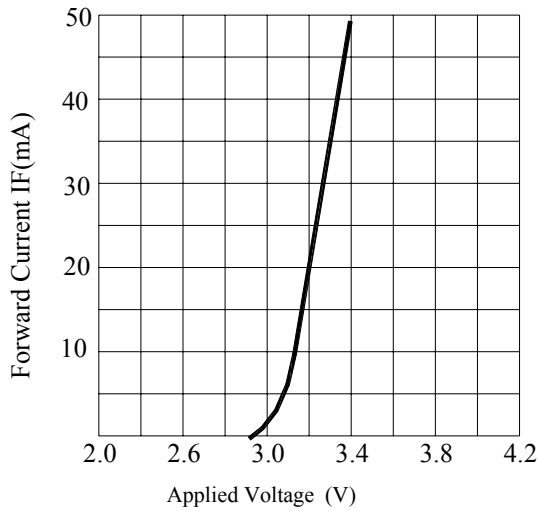

FORWARD CURRENT VS.APPLIED VOLTAGE

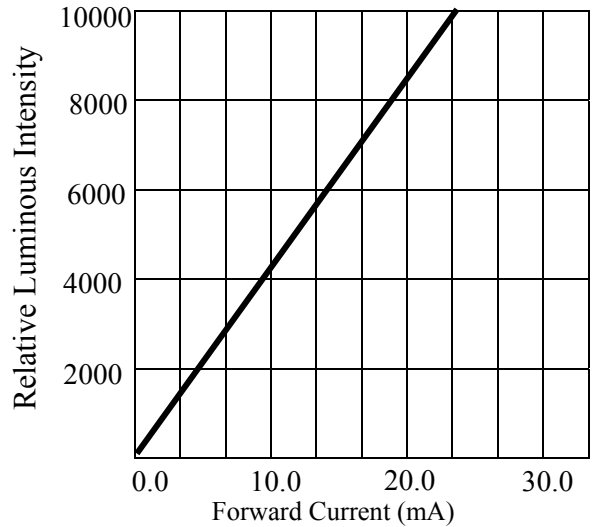

FORWARD CURRENT VS. LUMINOUS INTENSITY

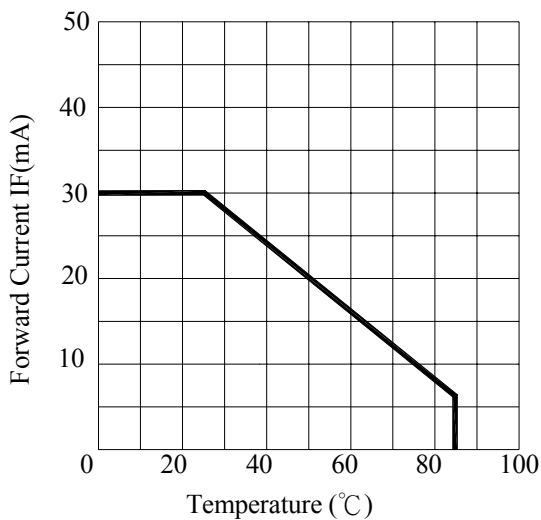

FORWARD CURRENT VS. AMBIENT TEMPERATURE

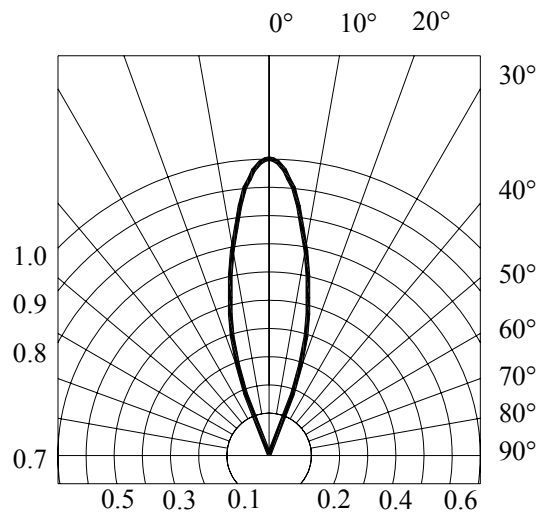

RADIATION DIAGRAM

Precautions:

TAKE NOTE OF THE FOLLOWING IN USE OF LED

1. Temperature in use

Since the light generated inside the LED needs to be emitted to outside efficiently, a resin with high light transparency is used; therefore, additives to improve the heat resistance or moisture resistance (silica gel, etc) which are used for semiconductor products such as transistors cannot be added to the resin.

Consequently, the heat resistant ability of the resin used for LED is usually low; therefore, please be careful on the following during use.

Avoid applying external force, stress, and excessive vibration to the resins and terminals at high temperature. The glass transition temperature of epoxy resin used for the LED is approximately 120-130°C.

At a temperature exceeding this limit, the coefficient of linear expansion of the resin doubles or more compared to that at normal temperature and the resin is softened.

If external force or stress is applied at that time, it may cause a wire rupture.

2. Soldering

Please be careful on the following at soldering.

After soldering, avoid applying external force, stress, and excessive vibration until the products go to cooling process (normal temperature), <Same for products with terminal leads>

(1) Soldering measurements:

Distance between melted solder side to bottom of resin shall be 1.6mm or longer.

(2) Dip soldering :

Pre-heat: 90°C max. (Backside of PCB), Within 60 seconds.

Solder bath: 260±5°C (Solder temperature), Within 5 seconds.

(3) Hand soldering: 350°C max. (Temperature of soldering iron tip), Within 3 seconds.

3. Insertion

Pitch of the LED leads and pitch of mounting holes need to be same.

4. Others

Since the heat resistant ability of the LED resin is low, SMD components are used on the same PCB, please mount the LED after adhesive baking process for SMD components. In case adhesive baking is done after LED lamp insertion due to a production process reason, make sure not to apply external force, stress, and excessive vibration to the LED and follow the conditions below.

Baking temperature: 120°C max. Baking time: Within 60 seconds.

If soldering is done sequentially after the adhesive baking, please perform the soldering after cooling down the LED to normal temperature.