



Chipsmall Limited consists of a professional team with an average of over 10 year of expertise in the distribution of electronic components. Based in Hongkong, we have already established firm and mutual-benefit business relationships with customers from,Europe,America and south Asia,supplying obsolete and hard-to-find components to meet their specific needs.

With the principle of “Quality Parts,Customers Priority,Honest Operation,and Considerate Service”,our business mainly focus on the distribution of electronic components. Line cards we deal with include Microchip,ALPS,ROHM,Xilinx,Pulse,ON,Everlight and Freescale. Main products comprise IC,Modules,Potentiometer,IC Socket,Relay,Connector.Our parts cover such applications as commercial,industrial, and automotives areas.

We are looking forward to setting up business relationship with you and hope to provide you with the best service and solution. Let us make a better world for our industry!



Contact us

Tel: +86-755-8981 8866 Fax: +86-755-8427 6832

Email & Skype: info@chipsmall.com Web: www.chipsmall.com

Address: A1208, Overseas Decoration Building, #122 Zhenhua RD., Futian, Shenzhen, China



MT9M113PACSTCH-GEVB

MT9M113 Evaluation Board User's Manual



ON Semiconductor®

www.onsemi.com

EVAL BOARD USER'S MANUAL

Evaluation Board Overview

The evaluation boards are designed to demonstrate the features of ON Semiconductor's image sensors products. This headboard is intended to plug directly into the Demo 2X system. Test points and jumpers on the board provide access to clock, I/Os and other miscellaneous signals.

Features

- Clock Input
 - ◆ Default – 10 MHz crystal oscillator
 - ◆ Optional Demo 2X controlled MClk
- Two Wire Serial Interface
 - ◆ Selectable base address
- Parallel Interface
- MIPI Interface
- ROHS Compliant

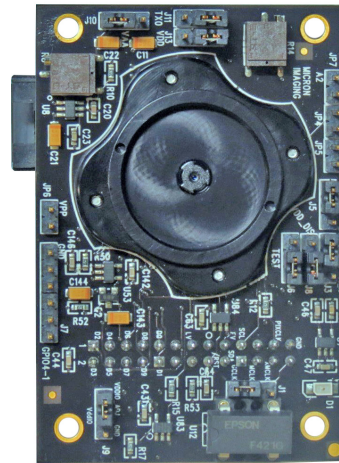

Figure 1. MT9M113 Evaluation Board

Block Diagram

To Demo2

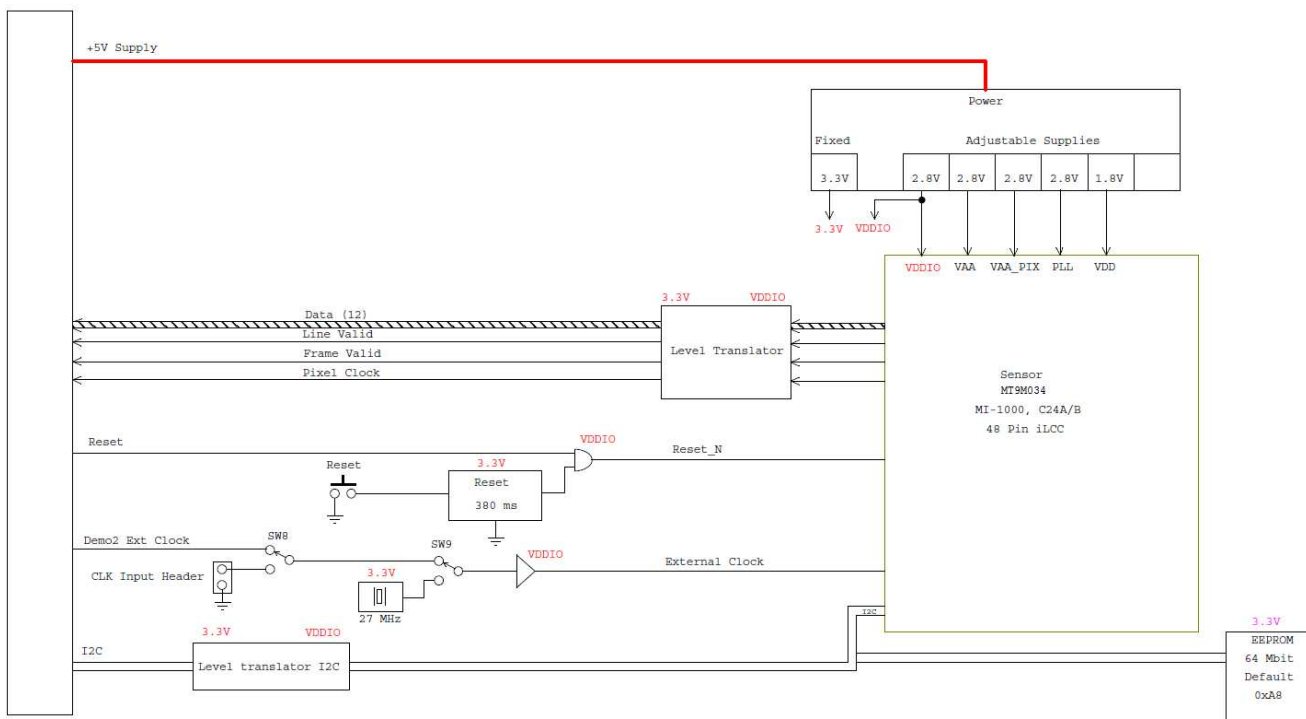

Figure 2. Block Diagram of MT9M113PACSTCH-GEVB

MT9M113PACSTCH-GEVB

Top View

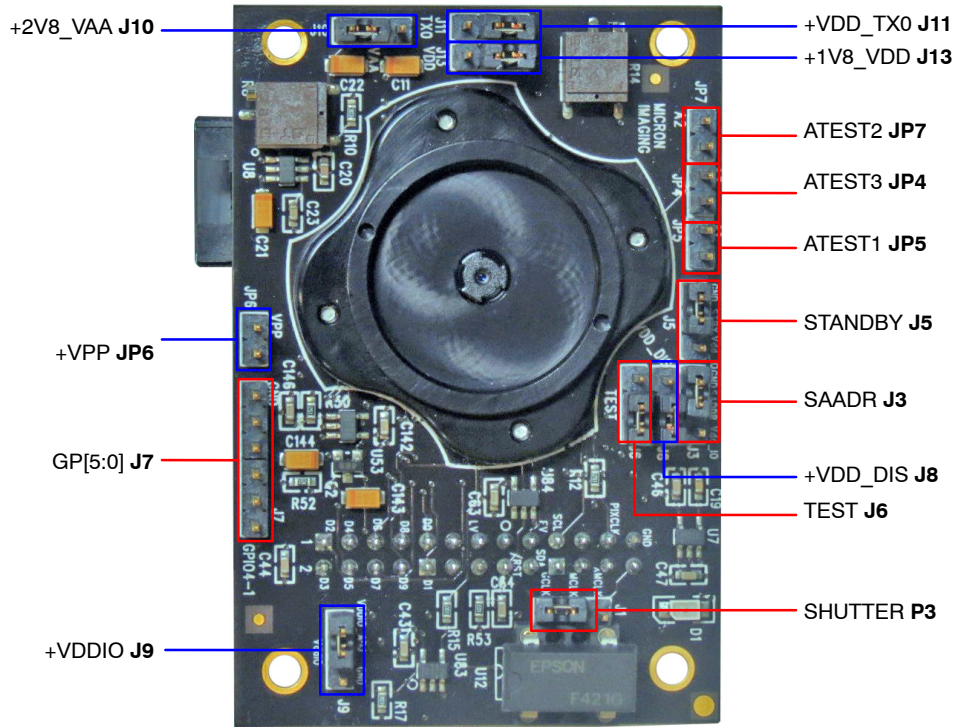

Figure 3. Top View of Evaluation Board – Default Jumpers

Bottom View

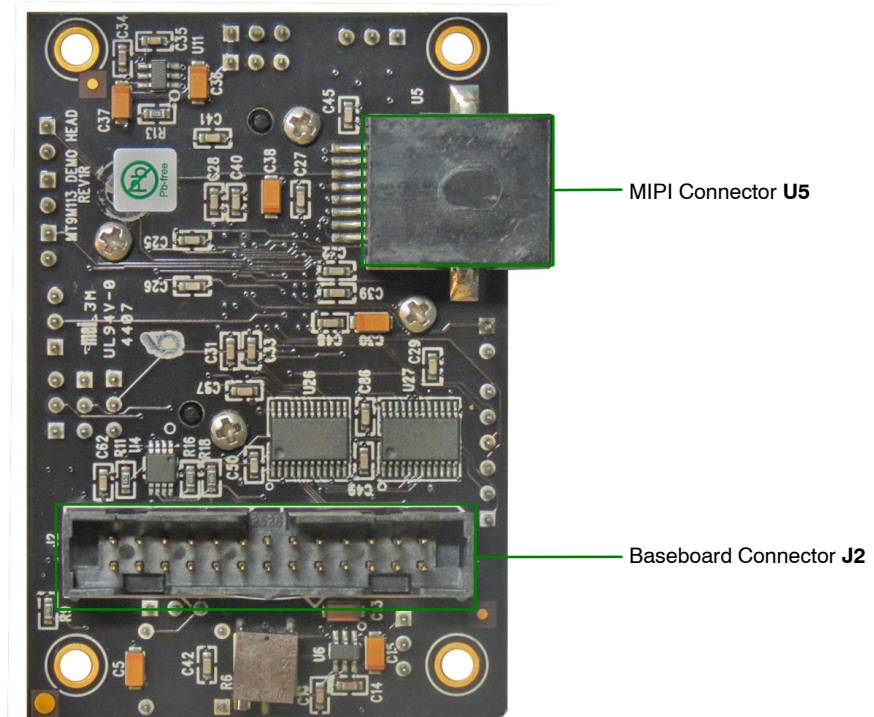

Figure 4. Bottom View of the Evaluation Board – Connector

MT9M113PACSTCH-GEVB

Jumper Pin Locations

The jumpers on headboards start with Pin 1 on the leftmost side of the pin. Grouped jumpers increase in pin size with each jumper added.

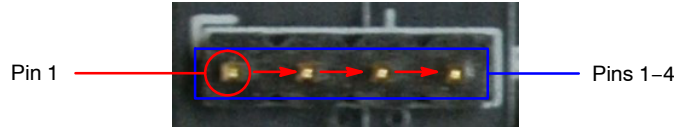

Figure 5. Pin Locations for a Single Jumper.
Pin 1 is Located at the Leftmost Side and Increases as it Moves to the Right

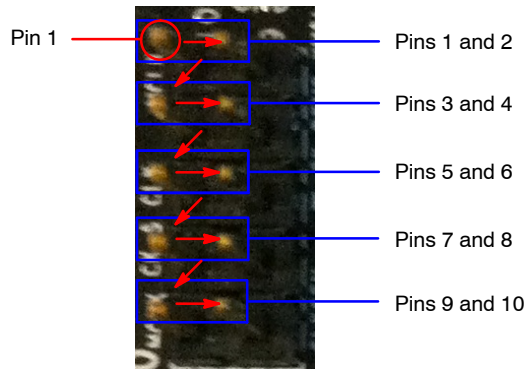

Figure 6. Pin Locations and Assignments of Grouped Jumpers.
Pin 1 is Located at the Top-Left Corner and Increases in a Zigzag Fashion Shown in the Picture

Jumper/Header Functions & Default Positions

Table 1. JUMPERS AND HEADERS

Jumper/Header No.	Jumper/Header Name	Pins	Description
J1	CLK_SELECT	2-3 (Default)	Connects to on-board oscillator
		1-2	Connects to XMCLK from Demo 2X Board
J3	SADDR	1-2 (Default)	I ² C Address set to 0x78
		2-3	I ² C Address set to 0x7A
J5	STANDBY	1-2 (Default)	Normal operation
		2-3	Sensor standby mode
J6	TEST	2-3 (Default)	Normal operation
		1-2	Test mode
J7	GP[5:0]	Open (Default)	For connection to various sensor's settings
J8	+VDD_DIS	2-3 (Default)	Normal operation
		1-2	Connects to on-board +VDDIO power supply
J9	+VDDIO	1-2 (Default)	Connects to on-board +VDDIO power supply
		2-3	External power supply connection
J10	+2V8_VAA	1-2 (Default)	Connects to on-board +2V8_VAA power supply
		2-3	External power supply connection
J11	+VDD_TX0	1-2 (Default)	Connects to on-board +VDD_TX0 power supply
		2-3	External power supply connection

MT9M113PACSTCH-GEVB

Table 1. JUMPERS AND HEADERS (continued)

Jumper/Header No.	Jumper/Header Name	Pins	Description
J13	+1V8_VDD	1-2 (Default)	Connects to on-board +1V8_VDD power supply
		2-3	External power supply connection
JP4	AATEST3	Open (Default)	For Debug/Test
JP5	AATEST1	Open (Default)	For Debug/Test
JP6	+VPP	Open (Default)	For connection to external +VPP power supply for OTPM
JP7	AATEST2	Open (Default)	For Debug/Test

Interfacing to ON Semiconductor Demo 2X Baseboard

The ON Semiconductor Demo 2X baseboard has a similar 26-pin connector which mates with J2 of the

headboard. The four mounting holes secure the baseboard and the headboard with spacers and screws.

ON Semiconductor and  are trademarks of Semiconductor Components Industries, LLC dba ON Semiconductor or its subsidiaries in the United States and/or other countries. ON Semiconductor owns the rights to a number of patents, trademarks, copyrights, trade secrets, and other intellectual property. A listing of ON Semiconductor's product/patent coverage may be accessed at www.onsemi.com/site/pdf/Patent-Marking.pdf. ON Semiconductor reserves the right to make changes without further notice to any products herein. ON Semiconductor makes no warranty, representation or guarantee regarding the suitability of its products for any particular purpose, nor does ON Semiconductor assume any liability arising out of the application or use of any product or circuit, and specifically disclaims any and all liability, including without limitation special, consequential or incidental damages. Buyer is responsible for its products and applications using ON Semiconductor products, including compliance with all laws, regulations and safety requirements or standards, regardless of any support or applications information provided by ON Semiconductor. "Typical" parameters which may be provided in ON Semiconductor data sheets and/or specifications can and do vary in different applications and actual performance may vary over time. All operating parameters, including "Typicals" must be validated for each customer application by customer's technical experts. ON Semiconductor does not convey any license under its patent rights nor the rights of others. ON Semiconductor products are not designed, intended, or authorized for use as a critical component in life support systems or any FDA Class 3 medical devices or medical devices with a same or similar classification in a foreign jurisdiction or any devices intended for implantation in the human body. Should Buyer purchase or use ON Semiconductor products for any such unintended or unauthorized application, Buyer shall indemnify and hold ON Semiconductor and its officers, employees, subsidiaries, affiliates, and distributors harmless against all claims, costs, damages, and expenses, and reasonable attorney fees arising out of, directly or indirectly, any claim of personal injury or death associated with such unintended or unauthorized use, even if such claim alleges that ON Semiconductor was negligent regarding the design or manufacture of the part. ON Semiconductor is an Equal Opportunity/Affirmative Action Employer. This literature is subject to all applicable copyright laws and is not for resale in any manner.

PUBLICATION ORDERING INFORMATION

LITERATURE FULFILLMENT:

Literature Distribution Center for ON Semiconductor
 19521 E. 32nd Pkwy, Aurora, Colorado 80011 USA
Phone: 303-675-2175 or 800-344-3860 Toll Free USA/Canada
Fax: 303-675-2176 or 800-344-3867 Toll Free USA/Canada
Email: orderlit@onsemi.com

N. American Technical Support: 800-282-9855 Toll Free
 USA/Canada
Europe, Middle East and Africa Technical Support:
 Phone: 421 33 790 2910
Japan Customer Focus Center
 Phone: 81-3-5817-1050

ON Semiconductor Website: www.onsemi.com
Order Literature: <http://www.onsemi.com/orderlit>
 For additional information, please contact your local
 Sales Representative