



Chipsmall Limited consists of a professional team with an average of over 10 year of expertise in the distribution of electronic components. Based in Hongkong, we have already established firm and mutual-benefit business relationships with customers from,Europe,America and south Asia,supplying obsolete and hard-to-find components to meet their specific needs.

With the principle of “Quality Parts,Customers Priority,Honest Operation,and Considerate Service”,our business mainly focus on the distribution of electronic components. Line cards we deal with include Microchip,ALPS,ROHM,Xilinx,Pulse,ON,Everlight and Freescale. Main products comprise IC,Modules,Potentiometer,IC Socket,Relay,Connector.Our parts cover such applications as commercial,industrial, and automotives areas.

We are looking forward to setting up business relationship with you and hope to provide you with the best service and solution. Let us make a better world for our industry!



## Contact us

Tel: +86-755-8981 8866 Fax: +86-755-8427 6832

Email & Skype: info@chipsmall.com Web: www.chipsmall.com

Address: A1208, Overseas Decoration Building, #122 Zhenhua RD., Futian, Shenzhen, China



## Peak Sensitivity Wavelength: 905nm

The MTAPD-07-xxx is a circular ( $\Phi 500\mu\text{m}$ ) .2 mm<sup>2</sup> active area Avalanche Photodiode with optimized sensitivity at 905nm & housed in a LCC6 SMD package. It is well suited for applications requiring High Speed & Low Noise in visible-near IR applications.

### FEATURES

- >Fast Rise Time
- >Ultra Low Noise
- >Low Capacitance
- >High Gain
- >Optimum Gain M100

- >Operating Voltages:  
120v - 160v  
160v - 200v  
Other Voltages Available

### APPLICATIONS

- >Optical rangefinders
- >High speed optical communications
- >Medical Equipment
- >Bar Code Readers

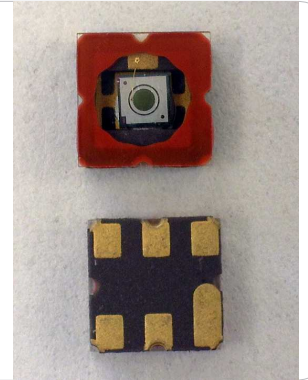

## Absolute Maximum Ratings



ITEMS	SYMBOL	RATINGS	UNIT
Storage Temperature	Tstg	-55 ~ +125	°C
Operating Temperature	Topr	-20 ~ +85	°C
Power Dissipation	Pd	1	mw
Forward Current	If	1	mA
Operating Voltage	Vop	0.95 x Vbr	V
Solder Reflow Temperature *1	Stemp	260	°C

\*1: Time 5 Sec max

## Electrical & Optical Characteristics (Ta=23°C)

ITEMS	SYMBOL	CONDITIONS	MIN.	TYP	MAX.	UNIT
Spectral Response	$\lambda$	--		400 - 1100		nm
Active Area		--		Diameter 500		um
Responsivity	Re	$\lambda=905\text{nm}$ , $\varphi_e=1\mu\text{W}$ , M=100	50	55	--	A/W
Rise Time	tR	f=1MHz, RL=50Ω, $\lambda=905\text{nm}$	--	0.6	--	ns
Dark Current	I <sub>D</sub>	M=100	0.1	0.4	1.0	nA
Capacitance	Cj	M=100, f=1MHz		1.2		pF
Optimal Gain	M	--		100		
Breakdown Voltage	Vbr	IR=2uA	80	--	200	V
Temperature Coefficient		Tc=-40°C - 85°C		0.9		V/°C

LCC6 SMD Package Dimensions (6 Pin)

MTAPD-07-015 Vbr=120-160V

MTAPD-07-016 Vbr=160-200V

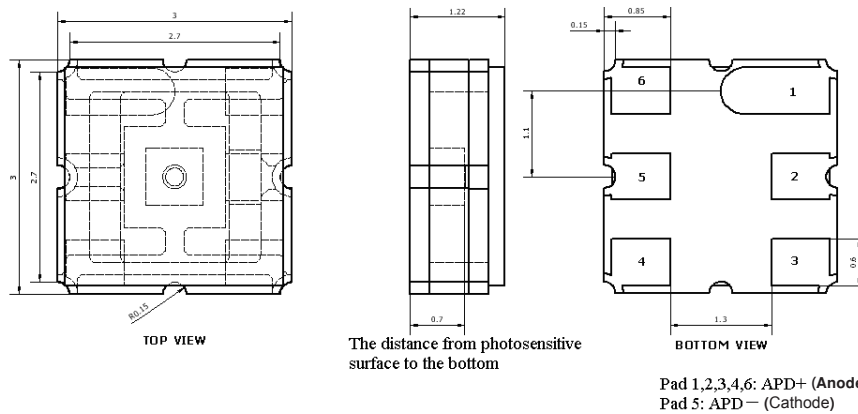

Unit: mm, Tolerance: ±0.2

Fig 1 Responsivity, Vr=0V

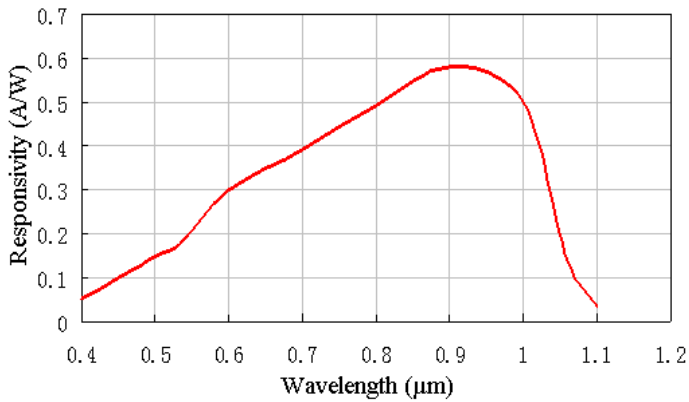

Fig 2 Dark Current

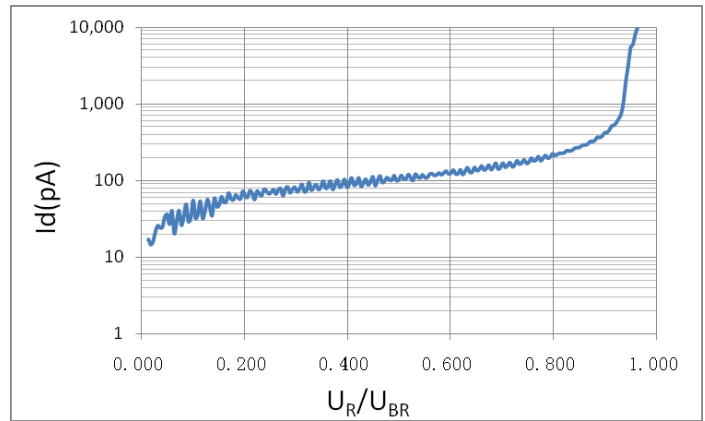

Fig 3 Multiplication

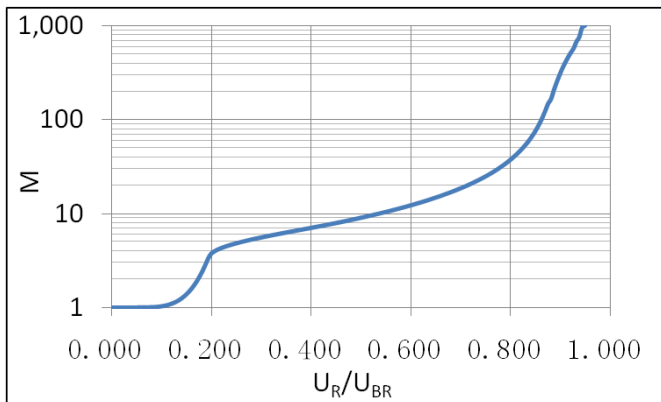
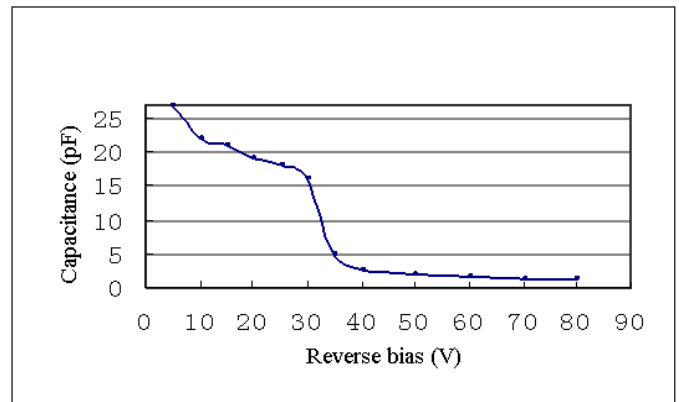
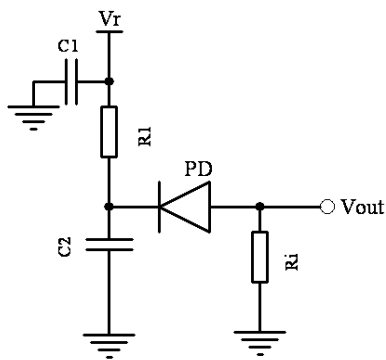

Fig 4 Capacitance



Applications Diagram



- Notes: C1 - Filter capacitor, filter noise from Vr.  
 C2 - bypass capacitor, the loop to ground for AC signal.  
 R1 - current-limiting resistor, protect APD from higher voltage.  
 Ri - sampling resistor, convert the current signal into a voltage signal.

Equivalent Circuit Diagram

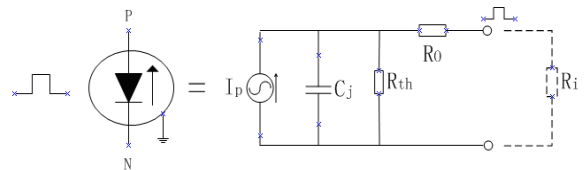

The information contained herein is subject to change without notice.



2015-10-29