



Chipsmall Limited consists of a professional team with an average of over 10 year of expertise in the distribution of electronic components. Based in Hongkong, we have already established firm and mutual-benefit business relationships with customers from,Europe,America and south Asia,supplying obsolete and hard-to-find components to meet their specific needs.

With the principle of “Quality Parts,Customers Priority,Honest Operation,and Considerate Service”,our business mainly focus on the distribution of electronic components. Line cards we deal with include Microchip,ALPS,ROHM,Xilinx,Pulse,ON,Everlight and Freescale. Main products comprise IC,Modules,Potentiometer,IC Socket,Relay,Connector.Our parts cover such applications as commercial,industrial, and automotives areas.

We are looking forward to setting up business relationship with you and hope to provide you with the best service and solution. Let us make a better world for our industry!



Contact us

Tel: +86-755-8981 8866 Fax: +86-755-8427 6832

Email & Skype: info@chipsmall.com Web: www.chipsmall.com

Address: A1208, Overseas Decoration Building, #122 Zhenhua RD., Futian, Shenzhen, China



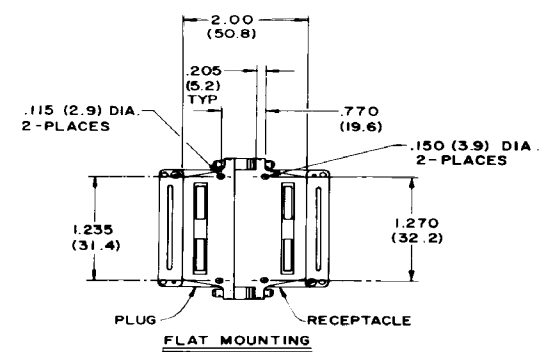
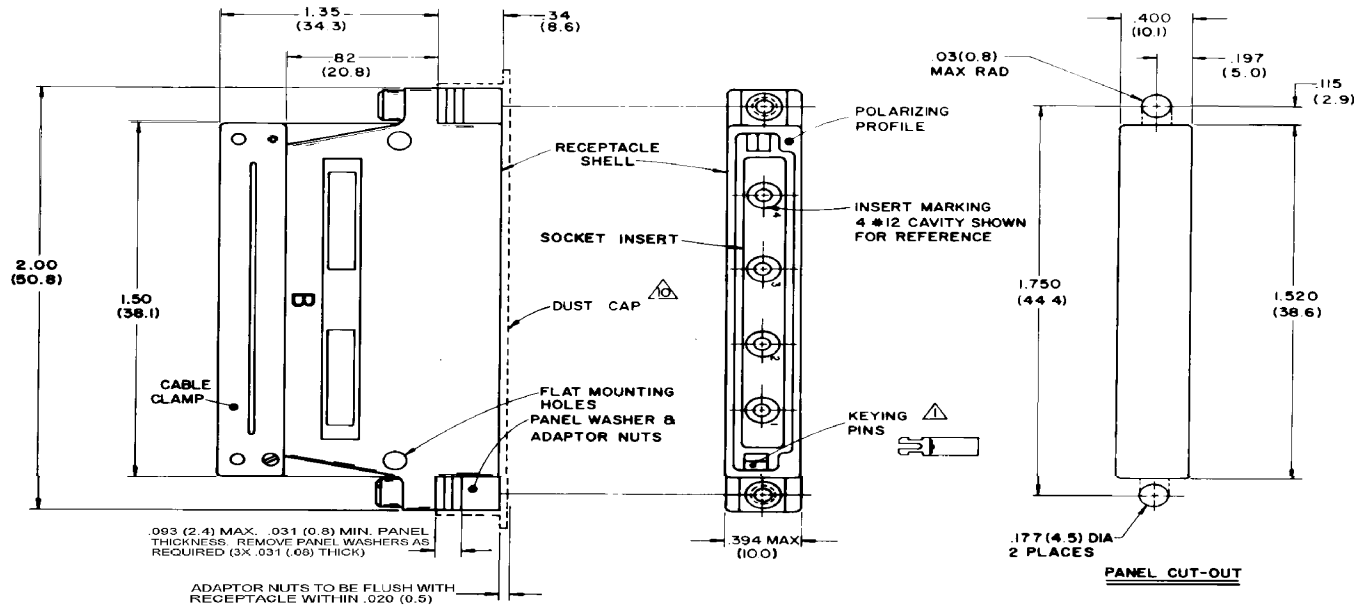

.093 (2.4) MAX. .031 (0.8) MIN. PANEL THICKNESS. REMOVE PANEL WASHERS AS REQUIRED (3X .031 (.60) THICK)

ADAPTOR NUTS TO BE FLUSH WITH RECEPTACLE WITHIN .020 (0.5)

NOTES:

- 1. KEYING CODE DOES NOT FORM A PART OF RAYCHEM PART NUMBER SYSTEM AND SHOULD BE OMITTED WHEN ORDERING. KEYING PINS SUPPLIED UNINSTALLED. SEE TABLE II FOR KEYING POSITIONS.
- 2. COMPLETE CONNECTORS AND ACCESSORIES ARE INDIVIDUALLY BAGGED AND LABELED.
- 3. CONNECTOR IS ENVIRONMENTALLY SEALED MEETING THE REQUIREMENTS PER CONNECTOR SPECIFICATION D-8015.
- 4. REAR GROMMET INSERT WILL SEAL ON SMOOTH INSULATION FROM .097" TO .168" O.D.
- 5. CONNECTOR DESIGNED FOR USE WITH POWER AND SHIELDED CONTACTS PER TABLE I.
- 6. INSERTS ARE PERMANENTLY INSTALLED, CONTACTS MAY BE INSERTED AND REMOVED USING TOOL PER NOTE 8.
- 7. ALL UNUSED CAVITIES TO BE SEALED USING SEALING PLUG NUMBER M83723-28-12.
- 8. ALL CONTACTS SIZE 12 ARE INSERTED AND REMOVED USING TOOL NUMBER M83723-31-12.
- 9. REFER TO RAYCHEM SPECIFICATION D-6015 FOR COMPLETE DETAILS.
- 10. CONNECTOR SUPPLIED WITH A SHIPPING DUST CAP OVER ENGAGING END.
- 11. PART NUMBER VARIABLE: MTCR-10X-04S

1- NICKEL PLATE PER MIL-C-26074
3- CADMIUM PLATE REP QQ-P-416 OVER NICKEL UNDERPLATE

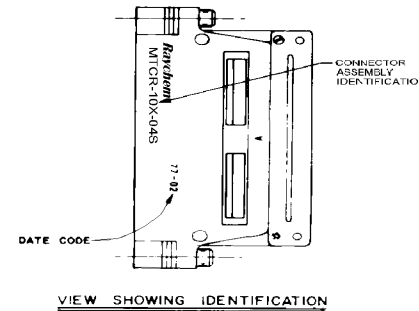

SPECIFICATION CONTROL DRAWING

| REV | DATE | PART NUMBER | REV | DESCRIPTION |
|-----|----------|-------------|-----|--|
| 1 | 12/27/98 | T22668a | 1 | REVISED PER EGN 12/27/98 |
| 2 | 01/17/99 | T22668a | 2 | REVISED PER DCR# T-22668 3/10/99 M.HICCY |

| | | |
|--|----------------------|---|
| UNLESS OTHERWISE SPECIFIED DIMENSIONS ARE IN INCHES AND TOLERANCES ARE: DEC .XXX .005 DEC .XX .02 ANGLE | CRN 9.20-77 S2477 | Raychem |
| CAD T22668a.TIF | PCN, NO. | CONNECTOR, RCPT, RECTANGULAR, ENVIRONMENTAL, FIXED SKT INSERT ONE INCH MTC SERIES |
| A | 06090 | DWG. NO. MTCR-10X-04S E |
| | | SHEET: 1 OF 2 |

If this document is printed it becomes uncontrolled.
Check with the web for latest revision.

TABLE II
KEYING CODE CHART 









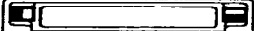

| PART NUMBER  | * * | POSITION OF KEYS |
|---|---------------|---|
| MTCR-10X-04S- | AA |  |
|  | AB |  |
| | AC |  |
| | AD |  |
| | BA |  |
| | BB |  |
| | BC |  |
| | BD |  |
| | CA |  |
| | CB |  |
| | CC |  |
| | CD |  |
| | DA |  |
| | DB |  |
| | DC |  |
| | DD |  |
| | MTCR-10X-04S- | |

TABLE I

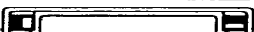
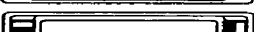
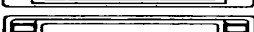
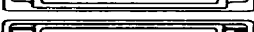
SOCKET CONTACT AND TOOLING INFORMATION

| CONTACT TYPE | MILITARY PART NO. | WIRE STRIP LENGTH | TERMINATION TOOL |
|---|-------------------|---|---|
| SHIELDED CONTACT FOR COAX CABLE D-602-0107 OR D-602-0095 | _____ | SEE DRAWING D-602-0107 OR D-602-0095 | SEE DRAWING D-602-0107 OR D-602-0095 |
| CONTACT FOR TWISTED PAIR D-602-0105 | _____ | SEE DRAWING D-602-0105 | SEE DRAWING D-602-0105 |
| POWER CONTACT SIZE 12 | M39029/5-12-12 | 1/4" TO 5/16" | M22520/1-01 POSITIONER M22520/1-02 |

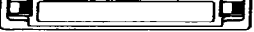
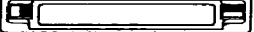
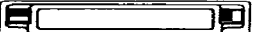
If this document is printed it becomes uncontrolled.
Check with the web for latest revision.

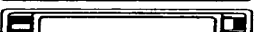
| | | | |
|---------------------------|-----------------|-----------------------|--------------|
| A | CODE IDENT. NO. | DWG. NO. | E |
| | 06090 | MTCR-10X-04S | |
| DO NOT SCALE THIS DRAWING | | CAD NAME: T22668D.TIF | SHEET 2 OF 2 |