



Chipsmall Limited consists of a professional team with an average of over 10 year of expertise in the distribution of electronic components. Based in Hongkong, we have already established firm and mutual-benefit business relationships with customers from,Europe,America and south Asia,supplying obsolete and hard-to-find components to meet their specific needs.

With the principle of "Quality Parts,Customers Priority,Honest Operation,and Considerate Service",our business mainly focus on the distribution of electronic components. Line cards we deal with include Microchip,ALPS,ROHM,Xilinx,Pulse,ON,Everlight and Freescale. Main products comprise IC,Modules,Potentiometer,IC Socket,Relay,Connector.Our parts cover such applications as commercial,industrial, and automotives areas.

We are looking forward to setting up business relationship with you and hope to provide you with the best service and solution. Let us make a better world for our industry!



## Contact us

Tel: +86-755-8981 8866 Fax: +86-755-8427 6832

Email & Skype: info@chipsmall.com Web: www.chipsmall.com

Address: A1208, Overseas Decoration Building, #122 Zhenhua RD., Futian, Shenzhen, China



## Peak Sensitivity Wavelength: 925nm

The MTD1114M3B is a photo diode in a ceramic package. It is well suited for high reliability and high sensitivity applications.

### FEATURES

- > Very High Light Current
- > Compact / Ceramic Package
- > High Reliability in Demanding Environments

### APPLICATIONS

- > Optical Switches
- > Optical Sensors
- > Optical Detectors

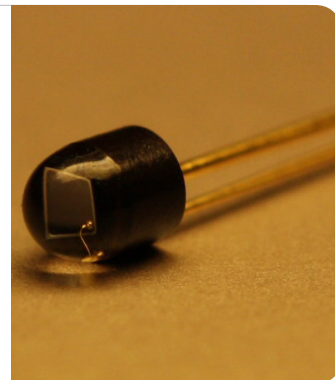

## Absolute Maximum Ratings (Ta=25°C)



ITEMS	SYMBOL	RATINGS	UNIT
Reverse Voltage	VR	20	V
Power Dissipation	PD	70	mW
Operating Temperature Range	Topr	-20 ~ +85	°C
Storage Temperature Range	Tstg	-30 ~ +100	°C
Junction Temperature	Tj	100	°C
Lead Soldering Temperature*1	Tls	260	°C

\*1: Time 5 Sec max, Position: Up to 3mm from the body.

## Electrical & Optical Characteristics (Ta = 25°C)

ITEMS	SYMBOL	CONDITIONS	MIN	TYP	MAX	UNIT
Open Circuit Voltage	Voc	Ee=5mW/cm <sup>2</sup> *1	--	0.35	--	V
Light Current	IL	*1, *2	--	38	--	μA
Dark Current	ID	VR=10V	--	0.5	5	nA
Curve Factor	CF	Ee=5mW/cm <sup>2</sup> *1	0.55	--	--	--
Spectral Sensitivity	λ	--	--	400~1100	--	nm
Peak Sensitivity Wavelength	λp	--	--	925	--	nm
Angular Response	Θ	--	--	±65	--	deg.
Switching Time (Rise Time)	Tr	RL=50Ω, Vr=0V	--	--	2	μS
Switching Time (Fall Time)	Tf	RL=50Ω, Vr=0V	--	--	2	μS
Junction Capacitance	Cj	at 1MHz, V=0V	--	100	130	pF

\*1: Color Temperature=2870°K Standard Tungsten Lamp, \*2: VR=10V, Ee=5mW/cm<sup>2</sup>.

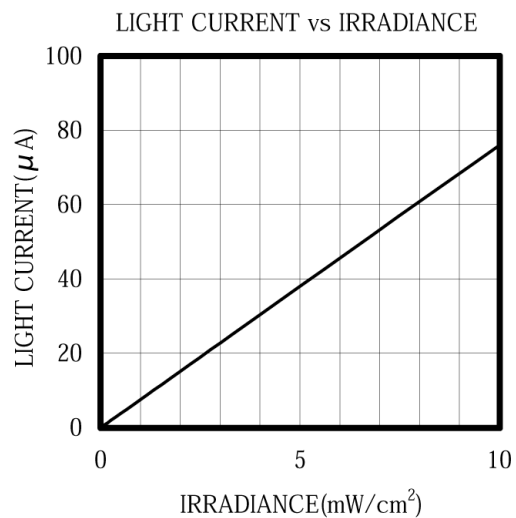
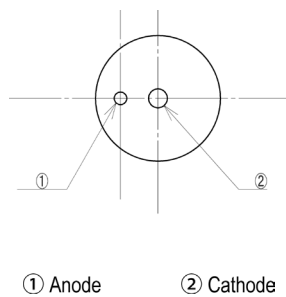
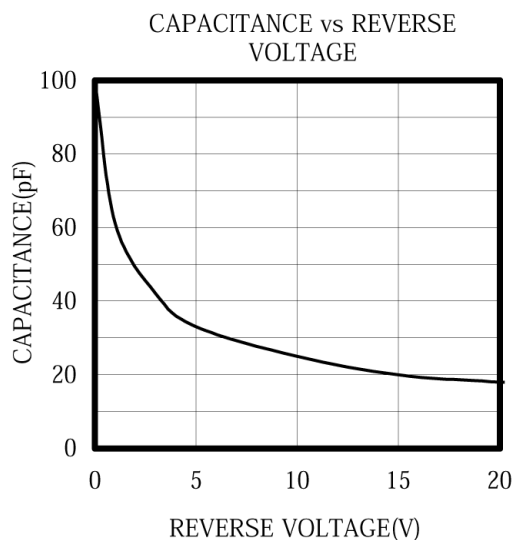
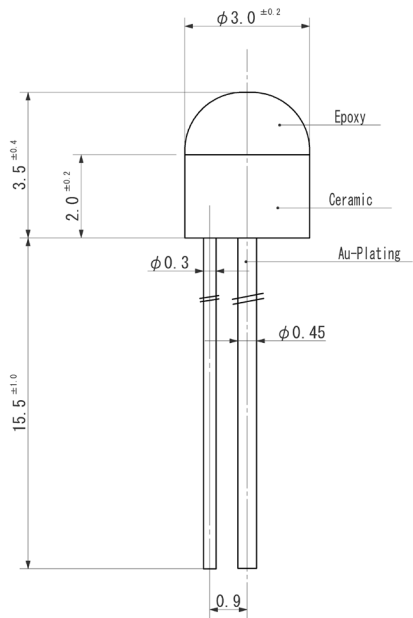

Unit: mm, Tolerance:  $\pm 0.2$

ANGULAR DISPLACEMENT

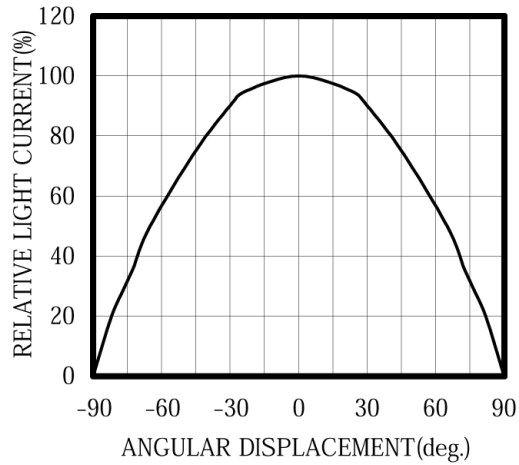

THERMAL DERATING CURVE

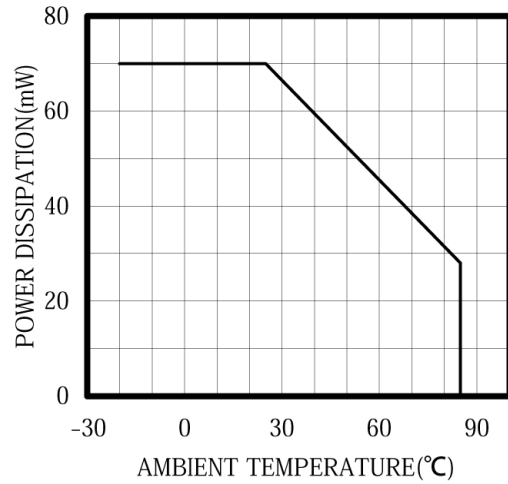

RESPONSIVITY

