



Chipsmall Limited consists of a professional team with an average of over 10 year of expertise in the distribution of electronic components. Based in Hongkong, we have already established firm and mutual-benefit business relationships with customers from,Europe,America and south Asia,supplying obsolete and hard-to-find components to meet their specific needs.

With the principle of “Quality Parts,Customers Priority,Honest Operation,and Considerate Service”,our business mainly focus on the distribution of electronic components. Line cards we deal with include Microchip,ALPS,ROHM,Xilinx,Pulse,ON,Everlight and Freescale. Main products comprise IC,Modules,Potentiometer,IC Socket,Relay,Connector.Our parts cover such applications as commercial,industrial, and automotives areas.

We are looking forward to setting up business relationship with you and hope to provide you with the best service and solution. Let us make a better world for our industry!



Contact us

Tel: +86-755-8981 8866 Fax: +86-755-8427 6832

Email & Skype: info@chipsmall.com Web: www.chipsmall.com

Address: A1208, Overseas Decoration Building, #122 Zhenhua RD., Futian, Shenzhen, China



Peak Sensitivity Wavelength: 880nm

The MTD8000M3B-T is a photo transistor in a ceramic package. It is well suited for high reliability and high sensitivity applications.

FEATURES

- > High Reliability in Demanding Environments
- > Ceramic Package
- > Compact

APPLICATIONS

- > Optical Switches
- > Optical Sensors
- > Optical Detectors

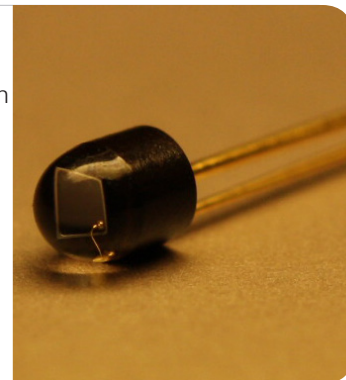

Absolute Maximum Ratings (Ta=25°C)



ITEMS	SYMBOL	RATINGS	UNIT
Collector-Emitter Voltage	Vceo	20	V
Emitter-Collector Voltage	Veco	5	V
Collector Current	Ic	30	mA
Collector Power Dissipation	Pc	80	mW
Operating Temperature Range	Topr	-25 ~ +85	°C
Storage Temperature Range	Tstg	-30 ~ +100	°C
Junction Temperature	Tj	100	°C
Lead Soldering Temperature*1	Tls	260	°C

*1: Time 5 Sec max, Position: Up to 3mm from the body.

Electrical & Optical Characteristics (Ta = 25°C)

ITEMS	SYMBOL	CONDITIONS	MIN	TYP	MAX	UNIT
Collector Emitter Current	Icel	Vce=10V, Ee=0.5mW/cm ² *1	--	1.0	--	mA
Collector Dark Current	Iceo	Vce=10V, Ee=0mW/cm ² *1	--	--	100	nA
C-E Saturation Voltage	VCE(sat)	Ic=0.2mA, Ee=5mW/cm ² *1	--	0.2	--	V
Spectral Sensitivity	λ	--	--	400~1100	--	nm
Peak Sensitivity Wavelength	λp	--	--	880	--	nm
Switching Time (Rise Time)	Tr	RL=100Ω, Vcc=5V, Ic=0.5mA	--	10.0	--	μS
Switching Time (Fall Time)	Tf	RL=100Ω, Vcc=5V, Ic=0.5mA	--	10.0	--	μS
Angular Response	θ	--	--	±80	--	deg

*1: Color Temperature=2870°K Standard Tungsten Lamp.

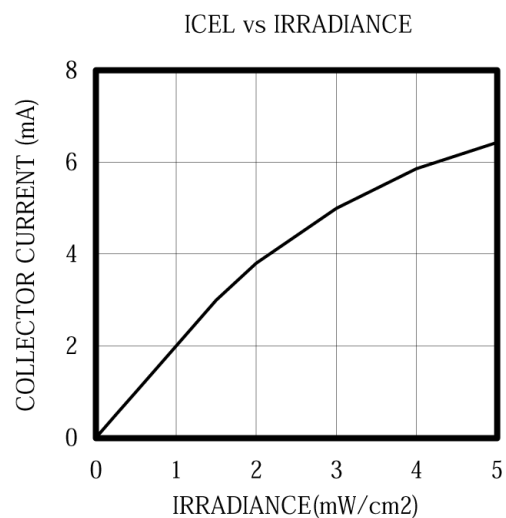
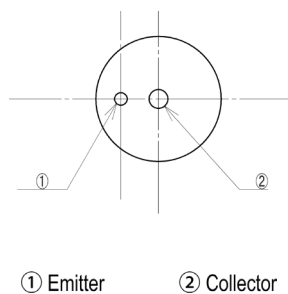
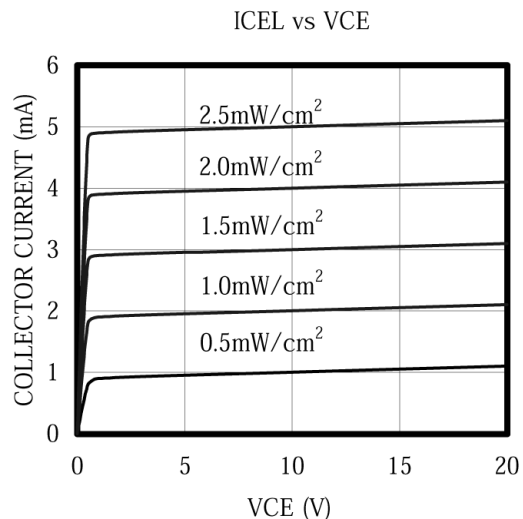
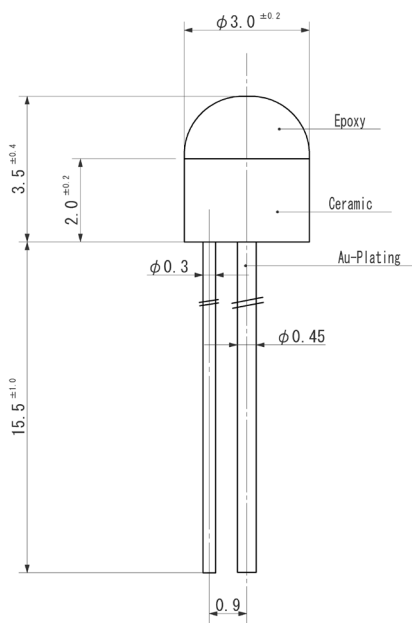

Unit: mm, Tolerance: ± 0.2

ANGULAR DISPLACEMENT

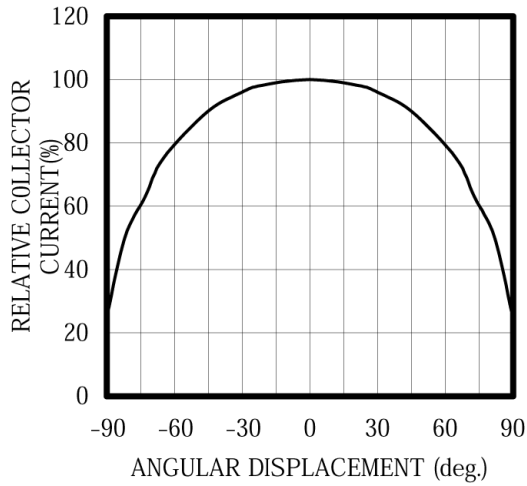

THERMAL DERATING CURVE

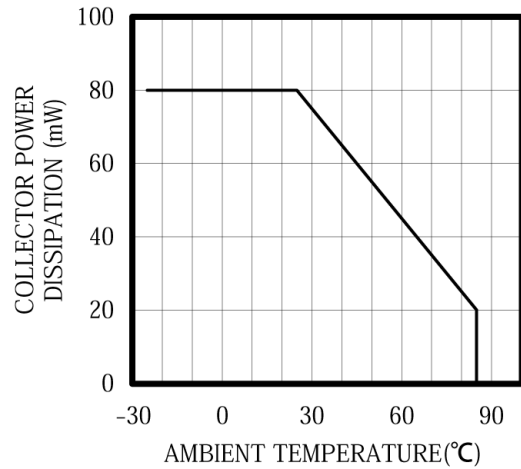

RELATIVE RESPONSE vs λ

