



Chipsmall Limited consists of a professional team with an average of over 10 year of expertise in the distribution of electronic components. Based in Hongkong, we have already established firm and mutual-benefit business relationships with customers from,Europe,America and south Asia,supplying obsolete and hard-to-find components to meet their specific needs.

With the principle of “Quality Parts,Customers Priority,Honest Operation,and Considerate Service”,our business mainly focus on the distribution of electronic components. Line cards we deal with include Microchip,ALPS,ROHM,Xilinx,Pulse,ON,Everlight and Freescale. Main products comprise IC,Modules,Potentiometer,IC Socket,Relay,Connector.Our parts cover such applications as commercial,industrial, and automotives areas.

We are looking forward to setting up business relationship with you and hope to provide you with the best service and solution. Let us make a better world for our industry!



## Contact us

Tel: +86-755-8981 8866 Fax: +86-755-8427 6832

Email & Skype: info@chipsmall.com Web: www.chipsmall.com

Address: A1208, Overseas Decoration Building, #122 Zhenhua RD., Futian, Shenzhen, China



## Peak Emission Wavelength: 765nm

The MTE2077N1-R is a red T 1 3/4, 5mm water clear emitter designed for applications requiring high power output and high reliability in a narrow angle package.

### FEATURES

- > High Reliability
- > Narrow Beam Angle
- > High Output Power

### APPLICATIONS

- > Optical Sensors
- > Optical Switches
- > Medical Application

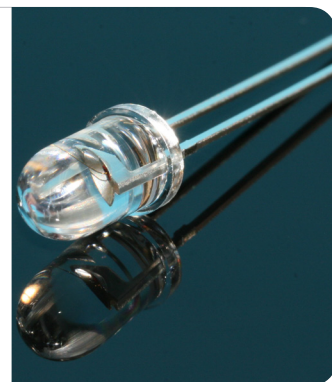

## Absolute Maximum Ratings (Ta=25°C)



ITEMS	SYMBOL	RATINGS	UNIT
Forward Current (DC)	IF	50	mA
Forward Current (Pulse)*1	IFP	0.5	A
Reverse Voltage	VR	5	V
Power Dissipation	PD	100	mW
Operating Temperature Range	ToPr	-20 ~ +80	°C
Storage Temperature Range	Tstg	-30 ~ +100	°C
Junction Temperature	Tj	100	°C
Lead Soldering Temperature*2	Tls	260	°C

\*1: Tw=10μsec, T=10msec; \*2: Time 5 Sec max, Position: Up to 3mm from the body.

## Electrical & Optical Characteristics (Ta = 25°C)

ITEMS	SYMBOL	CONDITIONS	MIN	TYP	MAX	UNIT
Power Output	PO	IF=20mA	--	8.0	--	mW
Forward Voltage	VF	IF=20mA	--	1.55	1.90	V
Reverse Current	IR	VR=5V	--	--	100	μA
Peak Emission Wavelength	λp	IF=20mA	--	765	--	nm
Spectral Line Half Width	Δλ	IF=20mA	--	35	--	nm
Half Intensity Beam Angle	Θ	IF=20mA	--	±8	--	deg

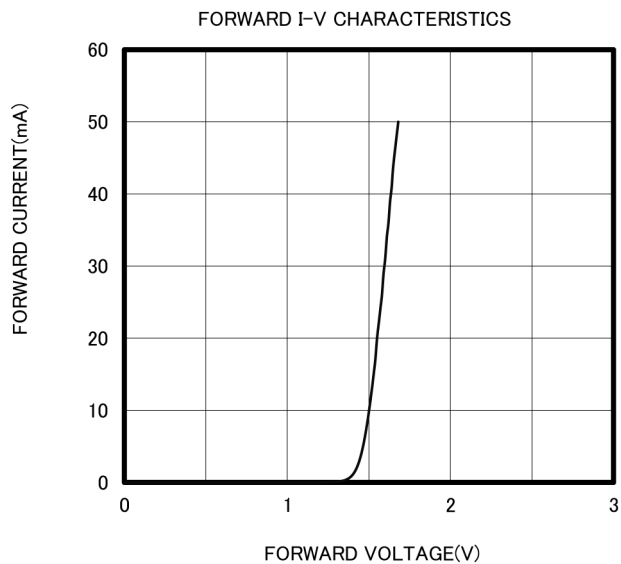
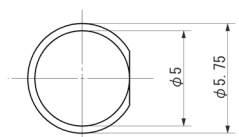
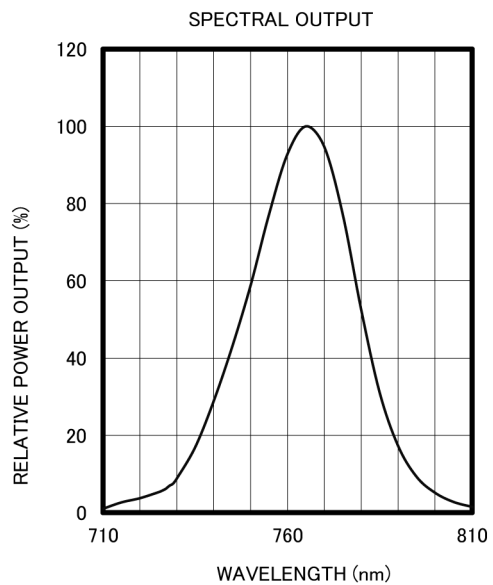
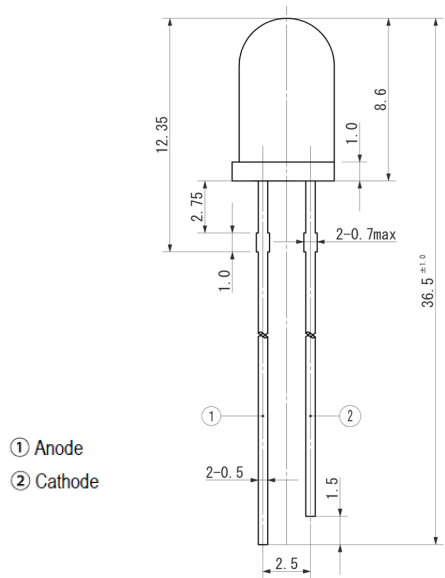

Unit: mm, Tolerance:  $\pm 0.2$

RELATIVE POWER vs FORWARD CURRENT

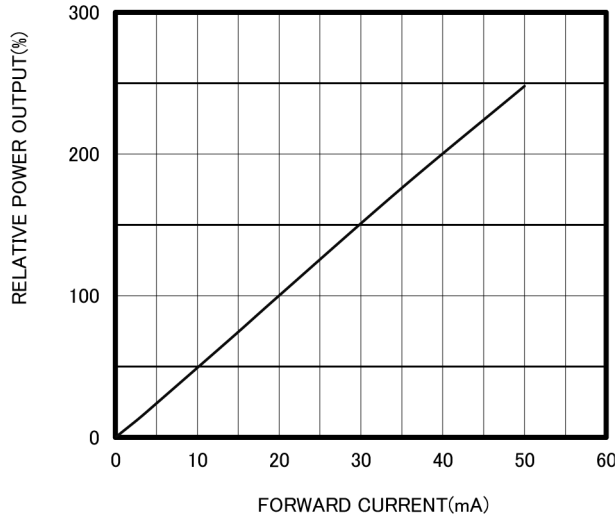

THERMAL DERATING CURVE

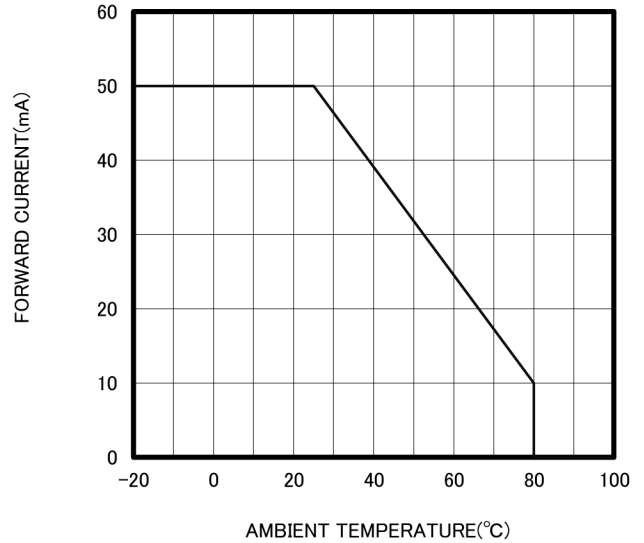

RADIATION PATTERN

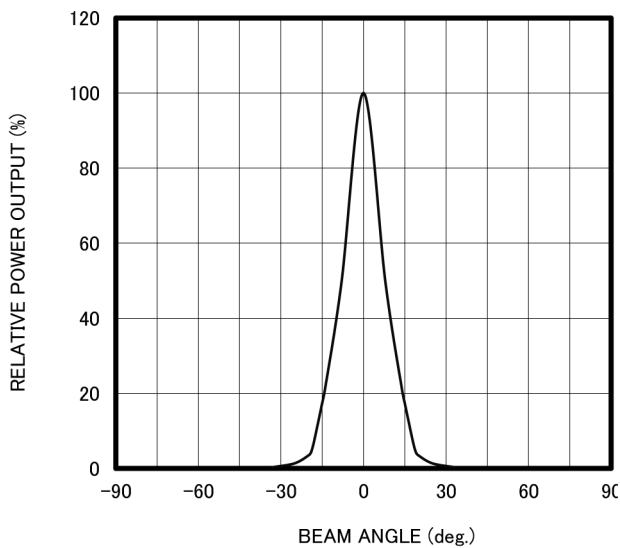

The information contained herein is subject to change without notice.

2012-10-17