



Chipsmall Limited consists of a professional team with an average of over 10 year of expertise in the distribution of electronic components. Based in Hongkong, we have already established firm and mutual-benefit business relationships with customers from,Europe,America and south Asia,supplying obsolete and hard-to-find components to meet their specific needs.

With the principle of “Quality Parts,Customers Priority,Honest Operation,and Considerate Service”,our business mainly focus on the distribution of electronic components. Line cards we deal with include Microchip,ALPS,ROHM,Xilinx,Pulse,ON,Everlight and Freescale. Main products comprise IC,Modules,Potentiometer,IC Socket,Relay,Connector.Our parts cover such applications as commercial,industrial, and automotives areas.

We are looking forward to setting up business relationship with you and hope to provide you with the best service and solution. Let us make a better world for our industry!



Contact us

Tel: +86-755-8981 8866 Fax: +86-755-8427 6832

Email & Skype: info@chipsmall.com Web: www.chipsmall.com

Address: A1208, Overseas Decoration Building, #122 Zhenhua RD., Futian, Shenzhen, China



Peak Emission Wavelength: 856nm

The 856nm IR emitter series is designed for applications requiring high output and precise optical / mechanical axis alignment. Custom package solutions and sorting are available.

FEATURES

- > TO-18 Metal Can Domed Package
- > High Output Power
- > High Reliability
- > Narrow Beam Angle

APPLICATIONS

- > Optical Switches / Security Systems
- > Linear & Rotary Encoder
- > Remote Controls / Robotics

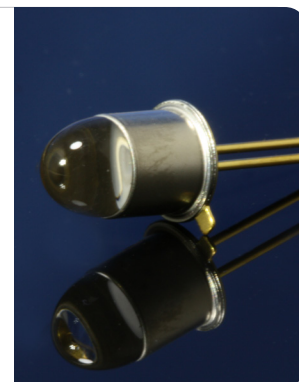

Absolute Maximum Ratings (Ta=25°C)



ITEMS	SYMBOL	RATINGS	UNIT
Forward Current	IF	80	mA
Forward Current (Pulse)*1	IFP	1	A
Reverse Voltage	VR	5	V
Power Dissipation	PD	180	mW
Operating Temperature Range	Topr	-20 ~ +85	°C
Storage Temperature Range	Tstg	-30 ~ +100	°C
Junction Temperature	Tj	100	°C
Lead Soldering Temperature*2	Tls	260	°C

*1: Tw=10μsec, T=10msec; *2: Time 5 Sec max, Position: Up to 3mm from the body.

Electrical & Optical Characteristics (Ta = 25°C)

ITEMS	SYMBOL	CONDITIONS	MIN	TYP	MAX	UNIT
Power Output	PO	IF=50mA	--	17	--	mW
Forward Voltage	VF	IF=50mA	--	1.4	1.6	V
Reverse Current	IR	VR=5V	--	--	100	μA
Peak Emission Wavelength	λp	IF=50mA	--	856	--	nm
Spectral Line Half Width	Δλ	IF=50mA	--	34	--	nm
Half Intensity Beam Angle	Θ	IF=50mA	--	±3	--	deg

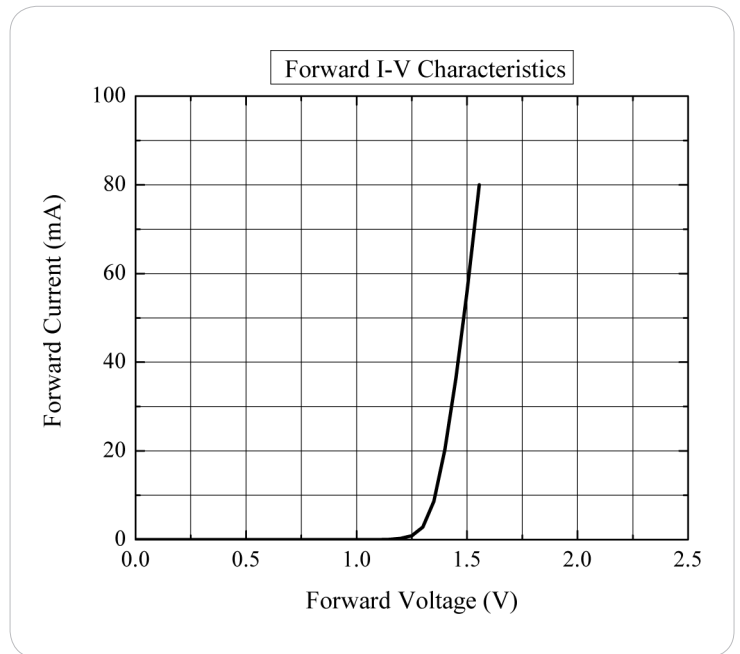
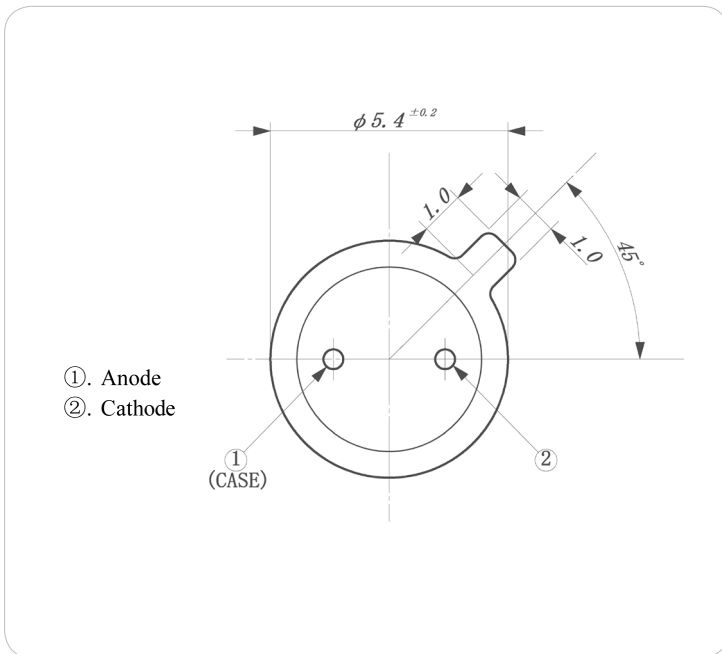
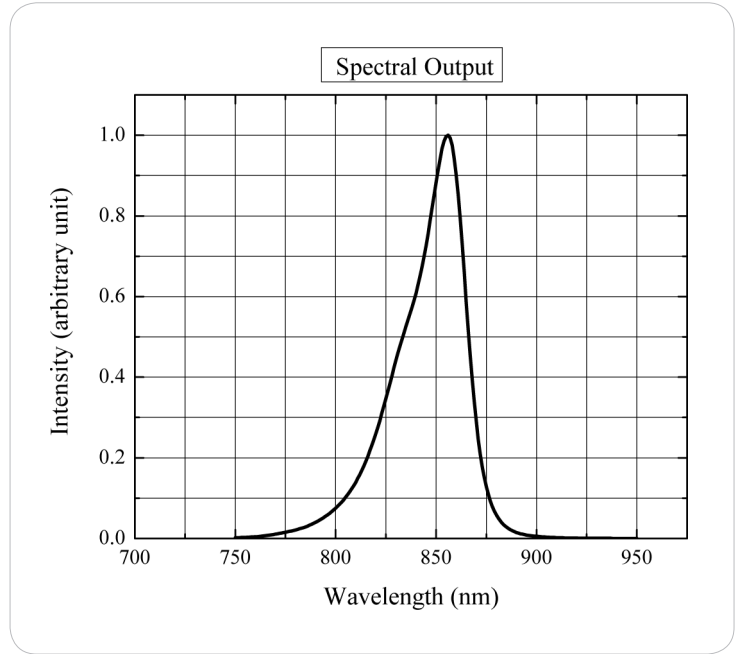
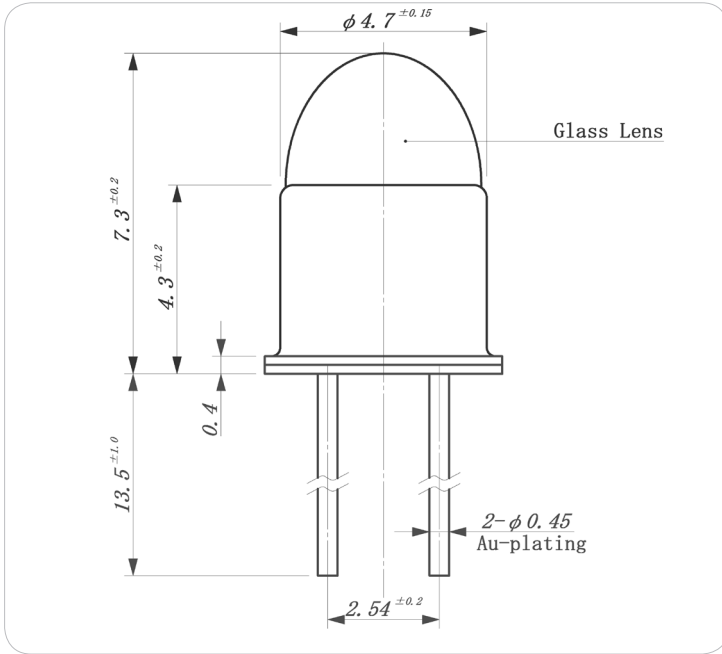

Unit: mm, Tolerance: ± 0.2

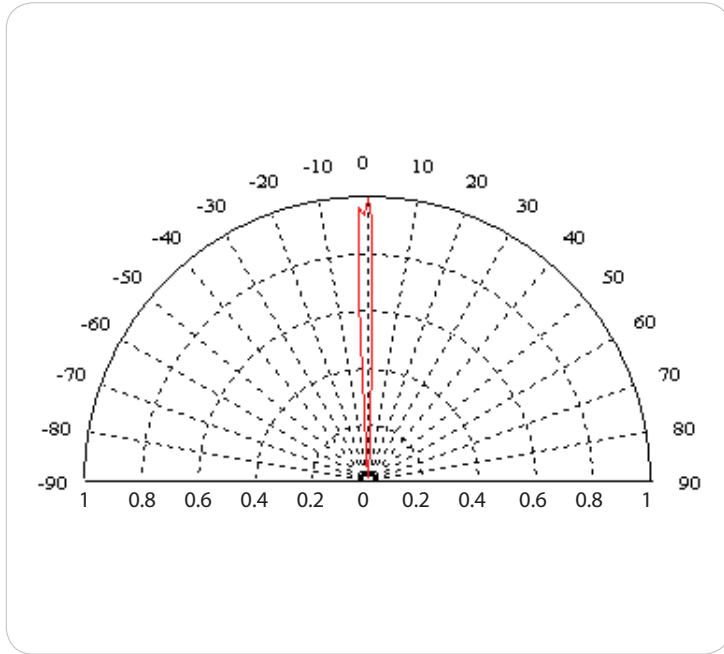
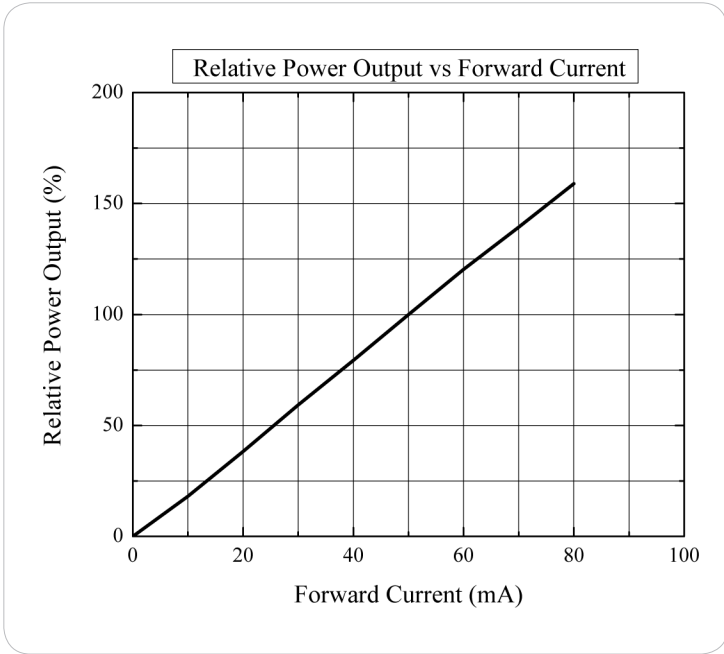

The information contained herein is subject to change without notice.

2012-01-06