



Chipsmall Limited consists of a professional team with an average of over 10 year of expertise in the distribution of electronic components. Based in Hongkong, we have already established firm and mutual-benefit business relationships with customers from,Europe,America and south Asia,supplying obsolete and hard-to-find components to meet their specific needs.

With the principle of “Quality Parts,Customers Priority,Honest Operation,and Considerate Service”,our business mainly focus on the distribution of electronic components. Line cards we deal with include Microchip,ALPS,ROHM,Xilinx,Pulse,ON,Everlight and Freescale. Main products comprise IC,Modules,Potentiometer,IC Socket,Relay,Connector.Our parts cover such applications as commercial,industrial, and automotives areas.

We are looking forward to setting up business relationship with you and hope to provide you with the best service and solution. Let us make a better world for our industry!



Contact us

Tel: +86-755-8981 8866 Fax: +86-755-8427 6832

Email & Skype: info@chipsmall.com Web: www.chipsmall.com

Address: A1208, Overseas Decoration Building, #122 Zhenhua RD., Futian, Shenzhen, China



REV.	MODIFICATION.	DATE	DRN
01	NEW DRAWING	28/06/01	KD
02	SC N2001-124	05/12/01	KD
03	SC N2002-015	08/02/02	KD
04	EC N2005-076	28/06/05	OW
05	EC N2005-092	30/08/05	TC
06	EC N2006-027	17/03/06	OW
07	EC N2007-031	08/02/07	SF
08	EC N2007-040	14/02/07	OW
09	EC N2007-046	15/02/07	SF
10	EC N2007-197	14/11/07	SF
11	CO2011253	12/04/12	SF

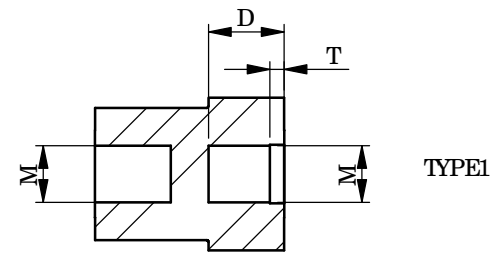
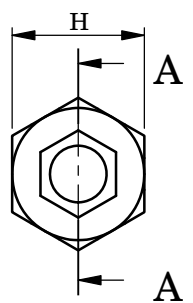
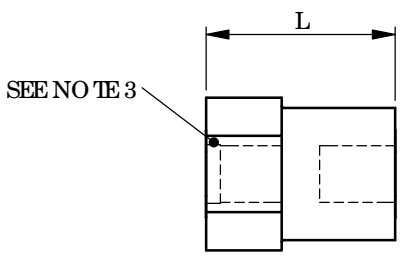

SECTION A-A
SCALE 2.5 : 1

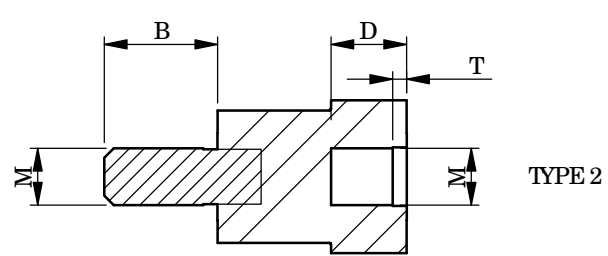
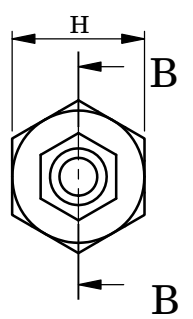
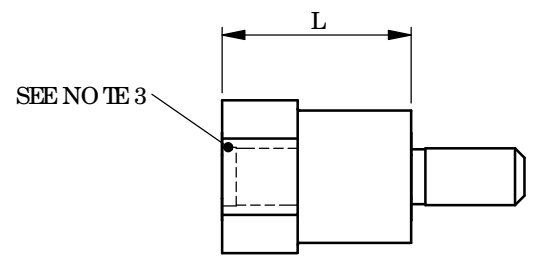

SECTION B-B
SCALE 2.5 : 1

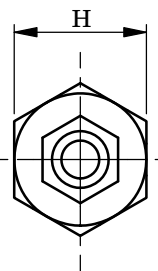
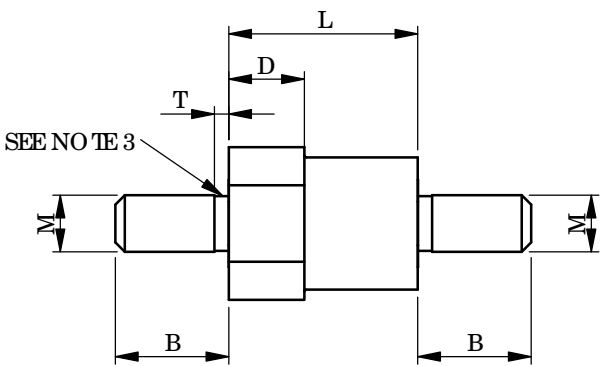

TYPE 3

NOTES

- 1) METRIC PRIMARY UNITS: mm
IMPERIAL SECONDARY UNITS: [inches]
- 2) INSERT & STUD MATERIAL = BRASS(RMS-231) - NICKEL PLATING (RMS-229)
BODY MATERIAL = NYLON 6 - WHITE (RMS-133)
(Parts available in UL94-V0 material by special order)
- 3) UNTHREADED LENGTH = 1.5 PITCH MAX
- 4) ALL MATERIALS TO COMPLY TO RESTRICTION OF HAZARDOUS SUBSTANCES (RoHS) EUROPEAN UNION DIRECTIVE

INFORMATION CONTAINED IN THIS DOCUMENT IS CONFIDENTIAL TO RICHCO INTERNATIONAL Co., Ltd. AND MAY NOT BE DISCLOSED OR REPRODUCED IN WHOLE OR PART WITHOUT THEIR WRITTEN CONSENT.

RICHCO, INC.
WWW.RICHCO-INC.COM

GENERAL TOLERANCES ±0.25 [0.010]
UNLESS OTHERWISE STATED
1 DECIMAL PLACE ±
2 DECIMAL PLACES ±
ANGULAR ±1°



PART NUMBER	M	H	B	D	T	LENGTH(L)
MTNSP-M2.5-L3	M2.5	6[.236]	6[.236]	-	-	4-12[.158-.472] (1mm INCREMENTS)
MTNSP-M2.5-L2				4[.158]	.68[.027]	7-12[.276-.472] (1mm INCREMENTS)
MTNSP-M2.5-L1				-	-	9-12[.354-.472] (1mm INCREMENTS)
MTNSP-M3-L3	M3	7[.276]	6[.236]	-	-	4-12[.158-.472] (1mm INCREMENTS)
MTNSP-M3-L2				4[.158]	.75[.030]	7-12[.276-.472] (1mm INCREMENTS)
MTNSP-M3-L1				-	-	9-12[.354-.472] (1mm INCREMENTS)

MATERIAL:		SEE NOTE 2		COLOUR:		SEE NOTE 2	
DESCRIPTION:				PART No:			
MTNSP-MX-H-L-TYPE				SEE TABLE			
DRG No:		NPR No:		SHEET SIZE		A4	
3060070		N/A					
DRN	DATE	CHKD	DATE	SCALE	SHEET No.		
OW	28/06/05	NBr	28/06/05	NTS	1 OF 1		